

FS 230

STIHL



2 - 19 Instruction Manual



Contents

1	Introduction.....	2
2	Guide to Using this Manual.....	2
3	Overview.....	2
4	Safety Precautions.....	3
5	Preparing Trimmer for Operation.....	9
6	Assembling the Trimmer.....	9
7	Adjusting Trimmer for User.....	11
8	Mixing Fuel and Refueling the Brushcutter	12
9	Starting and Stopping the Engine.....	13
10	Testing the Trimmer.....	14
11	Operating the Trimmer.....	14
12	After Finishing Work.....	15
13	Transporting.....	15
14	Storing.....	15
15	Cleaning.....	16
16	Maintenance.....	16
17	Repairing.....	17
18	Troubleshooting.....	17
19	Specifications.....	19
20	Combinations of Cutting Attachments, Deflectors and Carrying Systems.....	19
21	Spare Parts and Accessories.....	19
22	Disposal.....	19

1 Introduction

Dear Customer,

Thank you for choosing STIHL. We develop and manufacture our quality products to meet our customers' requirements. The products are designed for reliability even under extreme conditions.

STIHL also stands for premium service quality. Our dealers guarantee competent advice and instruction as well as comprehensive service support.

STIHL expressly commit themselves to a sustainable and responsible handling of natural resources. This user manual is intended to help you use your STIHL product safely and in an environmentally friendly manner over a long service life.

We thank you for your confidence in us and hope you will enjoy working with your STIHL product.



Dr. Nikolaus Stihl

**IMPORTANT! READ BEFORE USING AND
KEEP IN A SAFE PLACE FOR REFERENCE.**

2 Guide to Using this Manual

2.1 Applicable Documentation

Local safety regulations apply.

- ▶ Read, understand and save the following documents in addition to this instruction manual:
 - Instruction manual and packaging of the cutting attachment you are using

2.2 Symbols used with warnings in the text

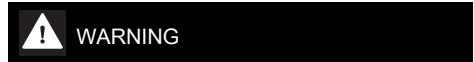

- This symbol indicates dangers that can cause serious injuries or death.
 - ▶ The measures indicated can avoid serious injuries or death.



- This symbol indicates dangers that can cause damage to property.
 - ▶ The measures indicated can avoid damage to property.

2.3 Symbols in Text



This symbol refers to a chapter in this instruction manual.

3 Overview

3.1 Brushcutter

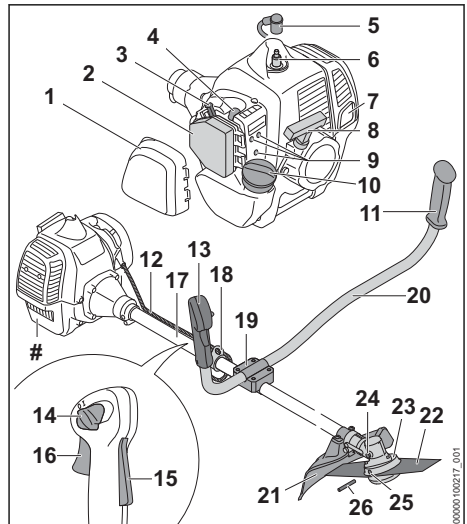

- 1 Filter cover**
Covers the air filter.
- 2 Air filter**
The air filter filters the air entering the engine.
- 3 Choke lever**
The choke lever helps start the engine.
- 4 Manual fuel pump**
The manual fuel pump makes it easier to start the engine.
- 5 Spark plug boot**
Connects the ignition lead to the spark plug.
- 6 Spark plug**
Ignites the fuel-air mixture in the engine.
- 7 Muffler**
Reduces brushcutter noise emissions.
- 8 Starter grip**
The starter grip is used for starting the engine.
- 9 Carburetor adjusting screws**
For tuning the carburetor.
- 10 Fuel tank cap**
The fuel tank cap closes the fuel tank.
- 11 Handle**
The handle is for holding and controlling the brushcutter.
- 12 Throttle cable**
Connects the throttle trigger to the engine.
- 13 Control handle**
The control handle is used for operating, holding and controlling the brushcutter.
- 14 Slide control**
Slide control is used to start, operate and stop the engine.
- 15 Throttle trigger lockout**
The throttle trigger lockout unlocks the throttle trigger.
- 16 Throttle trigger**
The throttle trigger is used to control the engine speed.
- 17 Shaft**
The shaft connects all components.
- 18 Carrying ring**
The carrying ring is for attaching the carrying system.
- 19 Handlebar clamp**
The handlebar clamp connects the handlebar to the shaft.
- 20 Handlebar**
The handlebar connects the control handle and handle with the shaft.

- 21 Deflector for metal cutting attachments**
The deflector for metal cutting attachments protects the user from flying debris and contact with the metal cutting attachment.
- 22 Grass cutting blade**
The grass cutting blade cuts grass and weeds.
- 23 Gear housing**
The gear housing encloses the gearbox.
- 24 Screw plug**
The screw plug closes the filler opening for STIHL gear grease.
- 25 Opening for stop pin**
The opening for the stop pin accommodates the stop pin.
- 26 Stop pin**
The stop pin blocks the shaft while a cutting attachment is being mounted.

Rating plate with the machine number

3.2 Symbols

Meanings of symbols that may be on the trimmer and the deflector:



This symbol denotes the fuel tank.



This symbol denotes the manual fuel pump.

START This symbol denotes the starter grip and the engine is started with the slide control in this position.



Engine is operated with the slide control in this position.

STOP-0 Engine is stopped when the slide control is in this position.



Slide control is moved in this direction to stop the engine.



Engine is started with the choke lever in this position.



Engine is made ready for start with the choke lever in this position.



This symbol shows the direction of rotation of the cutting attachment.



This symbol shows the rated speed of the cutting attachment.

4 Safety Precautions

4.1 Warning Symbols

Meanings of warning signs on the trimmer:



Observe safety notices and take the necessary precautions.



Read, understand and save the instruction manual.



Wear safety glasses, hearing protection and a hard hat.



Wear safety boots.



Wear work gloves.



Observe safety notices on kickback and take the necessary precautions.



Observe safety notices on flying debris and take the necessary precautions.



Maintain safe distance.



Do not touch hot surface.

4.2 Intended use

The STIHL FS 230 brushcutter is for mowing grass and weeds.

▲ WARNING

- Using the brushcutter for purposes other than those it is designed for may result in serious or fatal injuries and damage to property.
 - ▶ Use the brushcutter as described in this User Manual.

4.3 The Operator

▲ WARNING

- Users who have had no instruction cannot recognize or assess the risks involved in using the trimmer. The user or other persons may sustain serious or fatal injuries.



- ▶ Read, understand and save the instruction manual.

- ▶ If you pass the trimmer is on to another user: Always give them the instruction manual.
- ▶ Make sure the user meets the following requirements:
 - The user must be rested.
 - The user must be in good physical condition and mental health to operate and work with the trimmer. If the user's physical, sensory or mental ability is restricted, he or she may work only under the supervision of or as instructed by a responsible person.
 - The user is able to recognize and assess the risks involved in using the trimmer.
 - The user must be of legal age or is being trained in a trade under supervision in accordance with national rules and regulations.
 - The user has received instruction from a STIHL servicing dealer or other experienced user before working with the trimmer for the first time.
 - The user must not be under the influence of alcohol, medication or drugs.
- ▶ If you have any queries: Contact a STIHL servicing dealer for assistance.
- The trimmer's ignition system produces an electromagnetic field. This field may interfere with some pacemakers. This can result in serious or fatal injuries.
 - ▶ If the user has a pacemaker: Make sure the pacemaker is not affected.

4.4 Clothing and equipment

▲ WARNING

- Long hair can be drawn into the brushcutter during operation. This may result in serious injury to the user.
 - ▶ Tie up and confine long hair above your shoulders.
- Objects can be thrown at high speed during operation. This may result in injury to the user.
 - ▶ Wear close-fitting safety glasses. Suitable safety glasses are tested in accordance with EN 166 or national regulations and available commercially with the corresponding marking.
 - ▶ Wear face protection.
 - ▶ Wear long trousers made from resistant material.
- Noise is generated during operation. Noise can damage your hearing.





- ▶ Wear ear protection.

- Falling objects can cause head injuries.



- ▶ If objects are likely to fall while working: wear a hard hat.

- Dust can be whipped up during operation. Whipped up dust can damage the respiratory passages and cause allergic reactions.

- ▶ If dust is generated: Wear a dust respirator mask.

- Inappropriate clothing can snag on wood, brush or the brushcutter. Users not wearing suitable clothing are at risk of serious injury.

- ▶ Wear close-fitting clothing.
- ▶ Remove scarves and jewelry.

- The user may come into contact with the rotating cutting attachment during operation. This may result in serious injury to the user.

- ▶ Wear robust footwear.



- ▶ If you are using a metal cutting attachment: Wear steel-toed safety boots.

- ▶ Wear long trousers made from resistant material.

- When mounting and dismantling the cutting attachment and during cleaning or maintenance, the user may come into contact with the sharp edges of the cutting attachment or the crosscut blade. This may result in injury to the user.



- ▶ Wear work gloves made from resistant material.

- Wearing unsuitable footwear may cause the user to slip. This may result in injury to the user.

- ▶ Wear sturdy, closed-toed footwear with high-grip soles.

4.5 Working Area and Surroundings

▲ WARNING

- Bystanders, children and animals are not aware of the dangers of the brushcutter or flying debris. This may result in serious injury to bystanders, children and animals and damage to property.



- ▶ Do not allow bystanders, children or animals within 15 meters of the work area.

- ▶ Maintain a clearance of 15 meters from objects.
- ▶ Do not leave the brushcutter unattended.
- ▶ Make sure that children cannot play with the brushcutter.
- Hot exhaust gas is emitted through the muffler while the engine is running. Hot exhaust gas can ignite easily flammable materials and cause a fire.
 - ▶ Keep exhaust gas well away from easily flammable materials.

4.6 Safe Condition

4.6.1 Brushcutter

The brushcutter is in a safe condition if the following points are observed:

- The brushcutter is not damaged.
- There is no fuel leaking from the trimmer.
- The fuel tank cap is closed.
- The brushcutter is clean.
- The controls function properly and have not been modified.
- A combination of cutting attachment and deflector recommended in this user manual is mounted.
- The cutting attachment and deflector are properly mounted.
- Genuine STIHL accessories for this brushcutter are fitted.
- The accessories are correctly attached.
- All accessible screws and fastening parts are firmly tightened.
- Cutting attachment does not run while engine is idling.

▲ WARNING

- If not in safe condition, components may no longer operate correctly, safety devices may be disabled and fuel leakage may occur. There is a risk of serious or fatal injury.
 - ▶ Work only with an undamaged brushcutter.
 - ▶ If fuel is leaking from the trimmer: Do not use the trimmer and contact a STIHL dealer for assistance.
 - ▶ Close the fuel tank cap.
 - ▶ If the brushcutter is dirty: Clean the brushcutter.
 - ▶ Never attempt to modify your brushcutter. Exception: Mounting one of the combinations of cutting attachment and deflector recommended in this user manual.
 - ▶ If the controls do not function properly: Do not use your brushcutter.
 - ▶ Fit genuine STIHL accessories for this brushcutter.

- ▶ Mount the cutting attachment and deflector as described in this user manual.
- ▶ Attach accessories as described in this User Manual or in the User Manual for the accessories.
- ▶ Tighten loose screws and fastening parts.
- ▶ If the cutting attachment rotates when the engine is idling: Rectify the malfunction.
- ▶ Never insert objects into the openings of the brushcutter.
- ▶ Replace worn or damaged labels.
- ▶ If you are unsure: Consult a STIHL servicing dealer.

4.6.2 Deflector

The deflector is in a safe condition if the following points are observed:

- The deflector is not damaged.
- If you are using the line limiting blade and skirt: Line limiting blade and skirt are correctly fitted.

▲ WARNING

- If components do not comply with safety requirements, they will no longer function properly and safety devices may be rendered inoperative. This can result in serious injuries.
 - ▶ Work only with an undamaged deflector.
 - ▶ If you are using the line limiting blade and skirt: Work with a correctly fitted line limiting blade and skirt.
 - ▶ If you have any queries: Contact your STIHL servicing dealer.

4.6.3 Metal cutting attachment

The metal cutting attachment is in a safe condition if the following points are observed:

- Metal cutting attachment and mounting hardware are undamaged.
- Metal cutting attachment is not warped.
- Metal cutting attachment is properly mounted.
- Metal cutting attachment is correctly sharpened.
- Cutting edges of the metal cutting attachment have no burrs.
- The wear limits are not exceeded.
- If a metal cutting attachment not manufactured by STIHL is used, it must not be heavier, thicker, of a different shape, of a lower quality, or larger in diameter than the largest metal cutting attachment approved by STIHL.

▲ WARNING

- If it is not in an safe condition, parts of the metal cutting attachment may come off and be

thrown at high speed. They may cause serious injury to persons.

- ▶ Never work with a damaged metal cutting attachment or damaged mounting hardware.
- ▶ Sharpen the metal cutting attachment correctly.
- ▶ Deburr the cutting edges with a file.
- ▶ Have the metal cutting attachment balanced by a STIHL servicing dealer.
- ▶ Observe and remain inside the wear limits.
- ▶ Use a metal cutting attachment specified in these instructions for use.
- ▶ If you have any doubts, be sure to consult a STIHL dealer.

4.7 Fuel Mixture and Refueling

▲ WARNING

- This brushcutter requires a fuel mixture of gasoline and two-stroke engine oil. Mixed fuel and gasoline are extremely flammable. If fuel mixture or gasoline make contact with open fire or hot objects, they can cause a fire or explosions. Persons may be seriously or fatally injured and property may be damaged.
 - ▶ Protect fuel mixture and gasoline from heat and fire.
 - ▶ Do not spill fuel mixture or gasoline.
 - ▶ If fuel is spilled: Wipe up fuel with a cloth and do not attempt to start engine until all parts of the brushcutter are dry.
 - ▶ Do not smoke.
 - ▶ Never refuel near a fire.
 - ▶ Shut off the engine and allow it to cool down before refueling.
 - ▶ Start the engine at least 3 meters from the fueling spot, outdoors only.
- Inhaling fuel fumes and gasoline fumes can have toxic effects.
 - ▶ Avoid inhaling fuel fumes or gasoline fumes.
 - ▶ Refuel in a well-ventilated location.
- The brushcutter becomes hot during operation. The fuel expands and excess pressure can build up in the tank. Fuel can escape as a spray when the fuel tank cap is opened. The escaping fuel can ignite. This may result in serious injury to the user.
 - ▶ Allow the brushcutter to cool down first and then open the fuel tank cap carefully.
- Clothing that has been in contact with fuel or gasoline will ignite more easily. Persons may be seriously or fatally injured and property may be damaged.

- ▶ If your clothing comes into contact with fuel or gasoline: Change your clothing.
- Fuel mix, gasoline and two-stroke engine oil can harm the environment.
 - ▶ Do not spill fuel, gasoline or two-stroke engine oil.
 - ▶ Dispose of fuel mix, gasoline and two-stroke engine oil in accordance with local regulations and environmental requirements.
- Fuel, gasoline or two-stroke engine oil can cause irritation if they come into direct contact with the skin or eyes.
 - ▶ Avoid contact with fuel, gasoline and two-stroke engine oil.
 - ▶ If skin contact occurs: Wash affected areas of skin with plenty of water and soap.
 - ▶ If the event of contact with eyes: Rinse eyes with plenty of water for at least 15 minutes and consult a doctor.
- The brushcutter's ignition system produces sparks. Unconfined sparks may cause a fire or an explosion in an easily combustible or explosive environment. Persons may be seriously or fatally injured and property may be damaged.
 - ▶ Use the spark plugs described in this instruction manual.
 - ▶ Insert and tighten down the spark plug.
 - ▶ Connect the spark plug boot and press it down firmly.
- The brushcutter can become damaged if it is run with a fuel mixture that includes unsuitable gasoline or an unsuitable two-stroke engine oil, and also if an incorrect mix ratio of gasoline and two-stroke engine oil is used.
 - ▶ Mix the fuel as described in this User Manual.
- The mixture of gasoline and two-stroke engine oil can separate or age if it is stored for a long period. The brushcutter can be damaged if it is used with a fuel mix that has become separated or has aged.
 - ▶ Before refueling the brushcutter: Thoroughly mix the fuel.
 - ▶ Use a mixture of gasoline and two-stroke engine oil that is not older than 30 days (STIHL MotoMix: 5 years).
- ▶ Start the engine as described in this instruction manual.
- ▶ If the cutting attachment is touching the ground or objects: Do not start the engine.
- The slide control is in position **START** for engine starts. Engine RPM in position **START** is higher than idle speed and the cutting attachment may rotate as soon as the engine runs. This may result in serious injury to the user.
 - ▶ Do not touch the cutting attachment.
 - ▶ Start the engine as described in this instruction manual.
- In certain situations, the user may no longer be able to concentrate on their work. The user can lose control of the trimmer, stumble or fall and be seriously injured.
 - ▶ Work calmly and methodically.
 - ▶ If light and visibility are poor: Do not use your trimmer.
 - ▶ Operate the trimmer alone.
 - ▶ Keep the cutting attachment close to the ground.
 - ▶ Watch out for obstacles.
 - ▶ Work standing on the ground and keep your balance.
 - ▶ If you start feeling fatigue: Take a break.
- Exhaust gas is produced when the engine is running. Breathing in exhaust gas can have toxic effects. Breathing in exhaust gas can have toxic effects.
 - ▶ Avoid inhaling exhaust gas.
 - ▶ Operate the trimmer in a well ventilated location.
 - ▶ In the event of nausea, headache, visual disturbances, problems with hearing or dizziness: Stop work and seek medical advice.
- The user's ability to hear and assess noises is restricted when wearing hearing protection with the engine running.
 - ▶ Work calmly and methodically.
- The user will not be able to control the trimmer properly if it is operated with the slide control in position **START**. This may result in serious injury to the user.
 - ▶ Check that the slide control is in position **I** during operation.
 - ▶ Start the engine as described in this instruction manual.
- The rotating cutting attachment can cut the user. This may result in serious injury to the user.
 - ▶ Do not touch the rotating cutting attachment.

4.8 Working

▲ WARNING

- If the engine is not started properly, the user may lose control of the trimmer. This may result in serious injury to the user.

- ▶ If the cutting attachment is blocked by an object: Shut off the engine. before clearing the jam.
- The machine can be damaged if you open the throttle while the cutting attachment is blocked by an object.
 - ▶ Shut off the engine. before clearing the jam.
- If the behavior of the trimmer changes during operation or feels unusual, it may no longer be in a safe condition. This may result in serious injury to people and damage to property.
 - ▶ Stop work and consult a STIHL servicing dealer.
- Trimmer vibrations may occur during operation.



- ▶ Wear gloves.

- ▶ Take breaks.
- ▶ If signs of a circulatory disturbance occur: Consult a doctor.
- If the cutting attachment makes contact with a foreign object during operation, the object or parts of it may be thrown at high speed. Persons may be injured or property may be damaged.
 - ▶ Remove foreign objects from the working area.
- If the rotating cutting attachment makes contact with a hard object, sparks may occur and the cutting attachment may be damaged. Sparks can cause fires in a flammable environment. Persons may be seriously or fatally injured, and property may be damaged.
 - ▶ Do not use in a flammable environment.
 - ▶ Make sure the cutting attachment is in a safe condition.
- Note that the cutting attachment continues to rotate for a short period after you release the trigger. Persons may be seriously injured.
 - ▶ Wait until the cutting attachment comes to a complete stop.
- In an emergency, the user may start to panic and forget to take off the carrying system. This may result in serious injury to the user.
 - ▶ Practice taking off the carrying system.

4.9 Reactive Forces

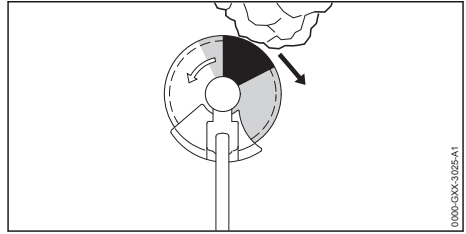

- Kickout can be caused for the following reasons:
- The shaded area or the black area of the rotating metal cutting attachment comes into contact with a solid object and is suddenly braked.
 - The rotating metal cutting attachment gets pinched in the cut.

The risk of kickout is greatest in the black area.

⚠ WARNING

- These situations can abruptly decelerate or stop rotation of the cutting attachment and cause the cutting attachment to be thrown to the right or in the direction of the user (black arrow). The user can lose control of the trimmer. This can result in serious or fatal injuries.
 - ▶ Hold the trimmer firmly with both hands.
 - ▶ Use the working techniques described in this instruction manual.
 - ▶ Do not use the black area for cutting.
 - ▶ Use a combination of cutting attachment, deflector and carrying system recommended in this instruction manual.
 - ▶ Sharpen the metal cutting attachment correctly.
 - ▶ Cut with the motor running at full speed.

4.10 Transporting

⚠ WARNING

- The gearbox can get hot during operation. There is a risk of burn injuries.
 - ▶ Do not touch a hot gearbox.
- The trimmer may turn over or shift during transport. This may result in personal injuries and damage to property.
 - ▶ Shut off the engine.
 - ▶ If a metal cutting attachment is mounted: Fit the transport guard.
 - ▶ Secure the trimmer with lashing straps or a net to prevent it turning over and moving.
- The muffler and engine may be hot after a period of operation. There is a risk of burn injuries.

- ▶ Carry the trimmer properly balanced by the drive tube with the cutting attachment behind you.

4.11 Storing

⚠ WARNING

- Children are not aware of and cannot assess the dangers of a trimmer and can be seriously injured.
 - ▶ Shut off the engine.
 - ▶ If a metal cutting attachment is mounted: Fit the transport guard.
 - ▶ Store the trimmer out of the reach of children.
- Dampness can corrode the electrical contacts on the trimmer and metal components. This can damage the trimmer.
 - ▶ Store the trimmer in a clean and dry condition.

4.12 Cleaning, maintenance and repair

⚠ WARNING

- The cutting attachment can start rotating unintentionally if the engine is running during cleaning, maintenance or repair operations. This may result in serious injury to people and damage to property.
 - ▶ Shut off the engine.
- The muffler and engine may be hot after a period of operation. This can result in burn injuries.
 - ▶ Wait until the muffler and engine cool down.
- The gear housing can get hot during operation. There is a risk of burn injuries.
 - ▶ Do not touch a hot gear housing.



- Aggressive cleaning agents, a water jet or pointed objects can damage the trimmer, deflector or the cutting attachment. If the trimmer, deflector and cutting attachment are not cleaned correctly, components may no longer function properly or safety devices may be rendered inoperative. Persons may be seriously injured.
 - ▶ Clean the brushcutter, deflector and cutting attachment as described in this User Manual.
- If the brushcutter, deflector or cutting attachment is not maintained or repaired as described in this User Manual, components may no longer function properly or safety devices may

be rendered inoperative. This can result in serious or fatal injuries.

- ▶ Maintain or repair the brushcutter and the deflector as described in this User Manual.
- ▶ Maintain the cutting attachment as described in the User Manual supplied with the cutting attachment being used or on the cutting attachment's packaging.
- The user can be cut by the sharp cutting edges while cleaning or maintaining cutting attachments. This may result in injury to the user.



- ▶ Wear work gloves made of robust material.

5 Preparing Trimmer for Operation

5.1 Preparing the Brushcutter for Operation

The following steps must be performed before commencing work:

- ▶ Ensure that the following components are in a safe condition:
 - Brushcutter, [14](#) 4.6.1.
 - Deflector, [14](#) 4.6.2.
 - Metal cutting attachment, [14](#) 4.6.3.
- ▶ Clean the brushcutter, [14](#) 15.1.
- ▶ Mount the bike handle, [14](#) 6.1.
- ▶ Select combination of cutting attachment, deflector and carrying system, [14](#) 20.
- ▶ Mount the deflector, [14](#) 6.2.
- ▶ Mount the metal cutting attachment, [14](#) 6.3.1.
- ▶ Fill the brushcutter with fuel, [14](#) 8.2.
- ▶ Fit and adjust the carrying system, [14](#) 7.1.
- ▶ Adjust the bike handle, [14](#) 7.2.
- ▶ Balance the brushcutter, [14](#) 7.3.
- ▶ Check the controls, [14](#) 10.1.
- ▶ If you cannot carry out this work: Do not use your brushcutter and contact your STIHL authorized dealer for assistance.

6 Assembling the Trimmer

6.1 Mounting the Bike Handle

- ▶ Shut off the engine.

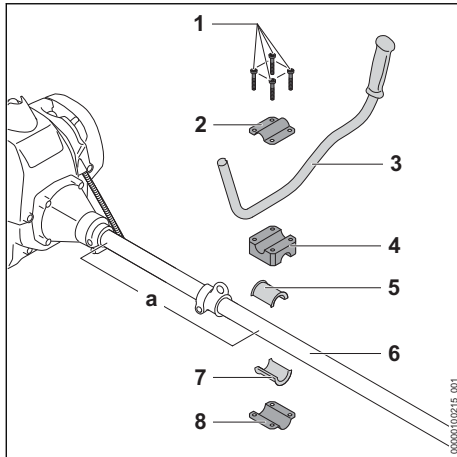

- ▶ Unscrew the screws (1).
- ▶ Fit the friction liner (7) together with the lower clamp (8) so that distance $a = 32.5$ cm.
- ▶ Fit the clamp (4) together with the friction liner (5).
- ▶ Place the handlebar (3) in the clamping piece (4). While doing so, do not clamp the curved part of the handlebar (3).
- ▶ Fit the upper clamping shell (2) so that the holes are in alignment.
- ▶ Insert the screws (1).
- ▶ Swing the handlebar (3) up and line it up with the cutting attachment.
- ▶ Tighten the screws (1) firmly.

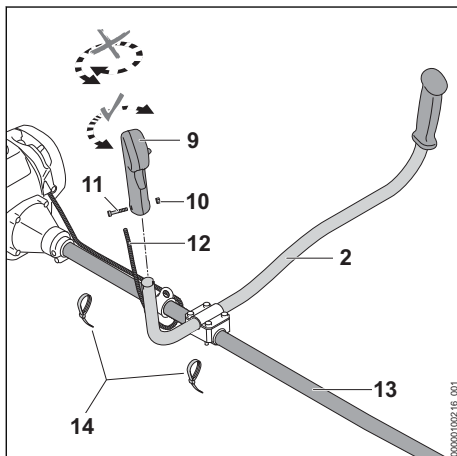

- ▶ Guide operating handle (9) through under the shaft (13) and the control handle (9), without twisting it.

The throttle cable (12) is now positioned under the shaft (13).

- ▶ Remove the screw (11).
- ▶ Position the control handle (9) on the handlebar (2), trigger facing the gearbox, and line up the hole in the control handle (9) with the hole in the handlebar (2).
- ▶ Fit the nut (10).
- ▶ Insert the screw (11) and secure it firmly.
- ▶ Using 2 cable ties (14) secure the throttle cable (12) to the shaft (13).

It is not necessary to remove the bike handle again.

6.2 Mounting the deflector

- ▶ Shut off the engine.

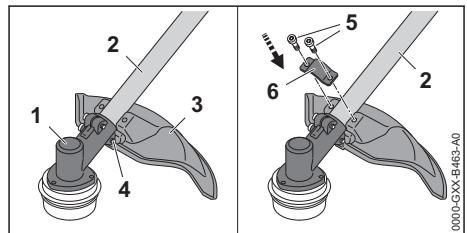

- ▶ Position the deflector (3) on the shaft (2) in such a way that the recess (4) rests against the gearbox (1).
- ▶ Place the clamp (6) on the shaft (2) in such a way that the holes are aligned.
- ▶ Insert screws (5) and tighten them.

Do not remove the deflector (3) again.

6.3 Removing and Installing Metal Cutting Attachment

6.3.1 Mounting the metal cutting attachment

- ▶ Shut off the engine.

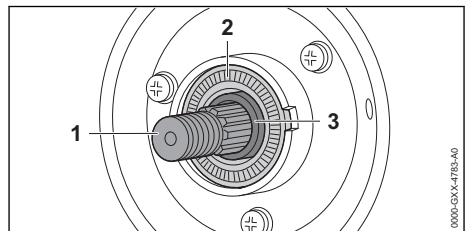

- ▶ If the sleeve (3) between the shaft (1) and the sealing ring (2) is missing: Do not use brush-cutter and contact your STIHL authorized dealer for assistance.

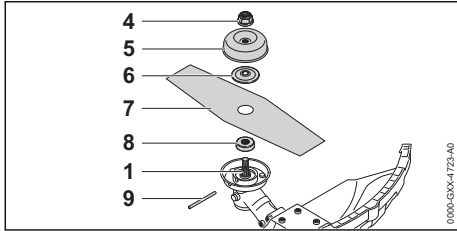

- ▶ Place the thrust plate (8) on the shaft (1) so that its smaller diameter faces up.
- ▶ Place the metal cutting attachment (7) on the thrust plate (8).
- ▶ Place the thrust washer (6) on the metal cutting attachment (7) so that its convex side faces up.
- ▶ Place the rider plate (5) on the thrust washer (6) so that its closed side faces up.
- ▶ Insert the stop pin (9) in the bore up to the limit stop and hold it depressed.
- ▶ Rotate the metal cutting attachment (7) counterclockwise until the stop pin (9) engages in position. The shaft (1) is now blocked.
- ▶ Fit the nut (4) counterclockwise and tighten it down firmly.
- ▶ Remove the stop pin (9).

6.3.2 Removing the Metal Cutting Attachment

- ▶ Shut off the engine.
- ▶ Insert the stop pin in the bore as far as stop and hold it depressed.
- ▶ Rotate the metal cutting attachment clockwise until the stop pin engages in position. The shaft is now blocked.
- ▶ Unscrew the mounting nut clockwise.
- ▶ Remove stop pin.
- ▶ Remove the rider plate, thrust washer, metal cutting attachment and thrust plate.

7 Adjusting Trimmer for User

7.1 Fitting and Adjusting the Carrying System

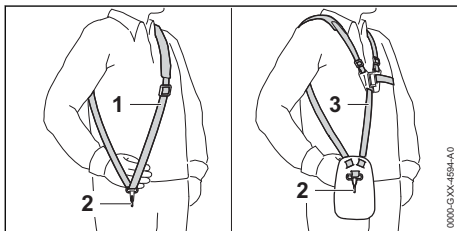

- ▶ Put on the shoulder strap (1) or full harness (3).
- ▶ Adjust the shoulder strap (1) or full harness (3) so that the carabiner (2) is about a hand's width below your right hip.

7.2 Adjusting the Bike Handle

The bike handle can be set to different positions to suit the height and reach of the user.

- ▶ Shut off the engine.
- ▶ Hook the brushcutter from the carrying ring into the carabiner of the carrying system.

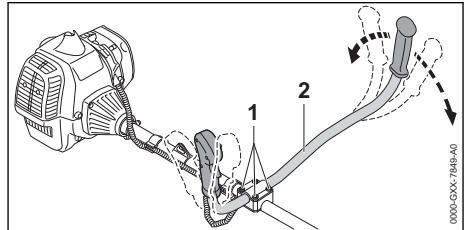

- ▶ Undo the screws (1).
- ▶ Swing the bike handle (2) to the required position.
- ▶ Tighten down the screws (1) firmly.

7.3 Balancing the Trimmer

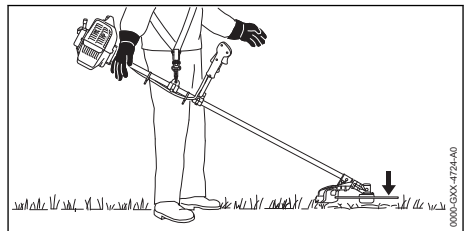

The cutting attachment should rest lightly on the ground.

- ▶ Shut off the engine.

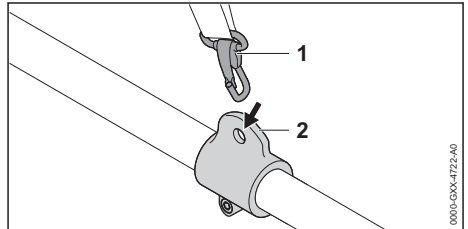

- ▶ Connect the carrying ring (2) to the carabiner (1).
- ▶ Wait for the trimmer to stop swinging.

- ▶ Check position of cutting attachment. If it needs adjustment:

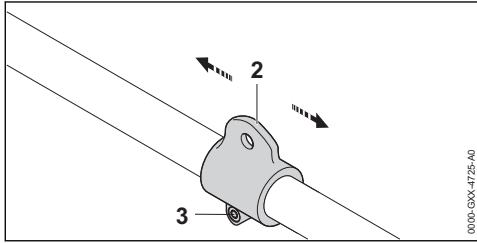

- ▶ Loosen the screw (3).
- ▶ Move carrying ring (2) up or down the drive tube until correct balanced position is reached.
- ▶ Tighten down the screw (3) firmly.

8 Mixing Fuel and Refueling the Brushcutter

8.1 Mixing fuel



A video is available for this chapter.



www.stihl.com/sxpweh

The fuel required for this brushcutter is a mixture of gasoline and two-stroke engine oil, in a mixing ratio of 1:50.

STIHL recommends you use STIHL MotoMix.

If you mix the fuel yourself, use only STIHL two-stroke engine oil or another high-performance engine oil classified as JASO FB, JASO FC, JASO FD, ISO-L-EGB, ISO-L-EGC or ISO-L-EGD.

STIHL specifies STIHL HP Ultra two-stroke engine oil or an equivalent high-performance engine oil in order to maintain emission limits over the machine's service life.

- ▶ Make sure that the octane number of the gasoline is at least 90 RON and the ethanol content is not more than 10% (for Brazil: 27%).
- ▶ Make sure the two-stroke engine oil you are using meets requirements.
- ▶ Depending on the desired amount of fuel, determine the correct amounts of two-stroke engine oil and gasoline in a mixing ratio of 1:50. Examples for fuel mixes:
 - 20 ml Two-stroke engine oil, 1 l gasoline
 - 60 ml Two-stroke engine oil, 3 l gasoline
 - 100 ml Two-stroke engine oil, 5 l gasoline

- ▶ Pour two-stroke engine oil into a clean approved fuel canister first and then add gasoline.
- ▶ Mix the fuel.

8.2 Filling the brushcutter with fuel

- ▶ Shut off the engine.
- ▶ Place your trimmer on a level surface so that the fuel tank cap faces up.
- ▶ Use a damp cloth to clean the fuel tank cap and the area around it.

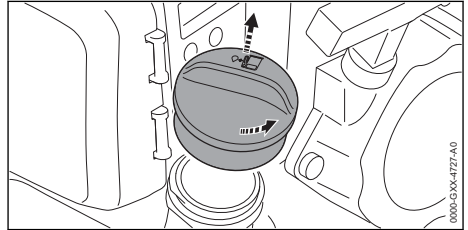

- ▶ Turn the tank cap counterclockwise until it can be removed.
- ▶ Remove the fuel tank cap.

NOTICE

- Exposure to light, direct sunlight and extreme temperatures may accelerate fuel separation or aging. The brushcutter can be damaged if it is used with a fuel mix that has become separated or has aged.
 - ▶ Mix the fuel before topping up.
 - ▶ Do not top up with fuel stored for more than 30 days (STIHL MotoMix: 5 years).
- ▶ When topping up, ensure that no fuel is spilled and that the fuel level remains at least 15 mm under the edge of the tank.

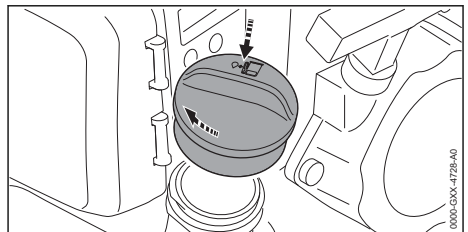

- ▶ Fit the fuel tank cap on the tank opening.
- ▶ Turn the tank cap clockwise and tighten it down firmly by hand.



The fuel tank is closed.

9 Starting and Stopping the Engine

9.1 Selecting the correct starting procedure

When must the engine be prepared for starting?

The engine must be prepared for starting if one of the following conditions apply:

- The engine is at ambient temperature.
- The engine stopped when accelerated for the first time.
- The engine stopped because the fuel tank was empty.
- ▶ Prepare engine for start,  9.2 and then start the engine,  9.3.

When can the engine be started without preparation?

The engine can be started without preparation if it has been running for at least 1 minute and only shut down for a short work break.

- ▶ Starting the engine,  9.3.

9.2 Preparing the engine for starting

- ▶ Select the correct starting procedure.
- ▶ Place the brushcutter on a level surface so that the cutting attachment does not touch the ground or other objects.
- ▶ Remove the transport guard.

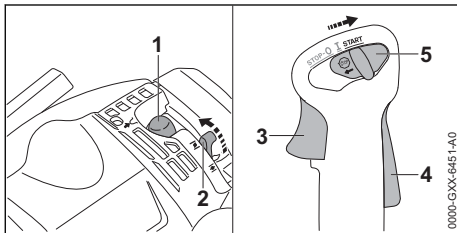

- ▶ Depress the manual fuel pump (1) at least 5 times.
- ▶ Move the choke lever (2) to position **H**.
- ▶ Press the throttle trigger lockout (4) and keep it pressed.
- ▶ Press the throttle trigger (3) and keep it pressed.
- ▶ Move the slide control (5) to position **START** and hold it there.
- ▶ Release the throttle trigger (3) and throttle trigger lockout (4).
The slide control (5) engages in position **START**.

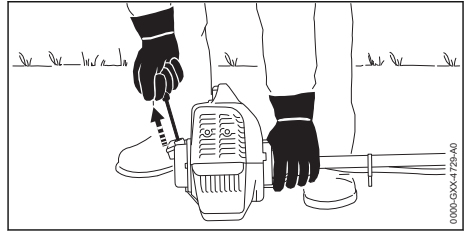

- ▶ Press the brushcutter to the ground with the left hand on the engine.
- ▶ Pull the starter grip slowly with your right hand until you feel it engage.
- ▶ Pull the starter grip quickly and allow the starter rope to rewind several times until the engine fires and stops.
- ▶ If the engine does not stop: Set the choke lever to **III** position so the engine does not stall and briefly press the throttle trigger (3).
The engine runs at idling speed, and the starting process has been completed.

9.3 Starting the engine

- ▶ Select the correct starting procedure.
- ▶ Place the brushcutter on a level surface so that the cutting attachment does not touch the ground or other objects.
- ▶ Remove the transport guard.

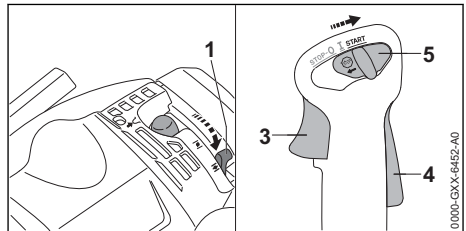

- ▶ Move the choke lever (1) to position **III**.
- ▶ Press the throttle trigger lockout (4) and keep it pressed.
- ▶ Press the throttle trigger (3) and keep it pressed.
- ▶ Move the slide control (5) to position **START** and hold it there.
- ▶ Release the throttle trigger (3) and throttle trigger lockout (4).
The slide control (5) engages in position **START**.

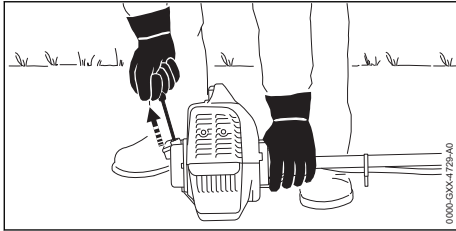

NOTICE

- The brushcutter can be damaged if pressed into the ground with your foot or knee.
 - ▶ Press the brushcutter against the ground with your left hand. Do not stand or kneel on the shaft.
-
- ▶ Press the brushcutter against the ground with your left hand.
 - ▶ Pull the starter grip slowly with your right hand until you feel it engage.
 - ▶ Pull the starter grip quickly and allow the starter rope to rewind several times until the engine runs.
 - ▶ Briefly press the throttle trigger (3).
The slide control (5) springs to position **I**. The engine runs at idling speed.
 - ▶ If the cutting attachment rotates when the engine is idling: Rectify the malfunction. Idle speed adjustment is not correct.
 - ▶ If the engine does not start: Prepare the engine for starting and then try again to start the engine.

9.4 Shut off the engine.

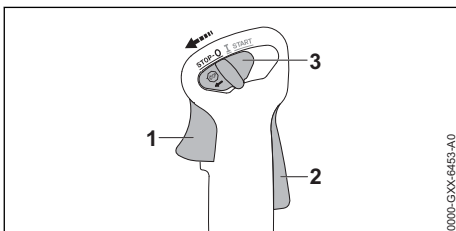

- ▶ Release the throttle trigger (1) and throttle trigger lockout (2).
The cutting attachment comes to a standstill.
- ▶ Move the slide control (3) to **STOP-0** position.
The engine stops.
- ▶ If the engine does not stop:
 - ▶ Move the choke lever to **I** position and press the throttle trigger (1).
The engine stops.

- ▶ Do not use your brushcutter and contact a STIHL servicing dealer for assistance.
There is a malfunction in the slide control.

10 Testing the Trimmer

10.1 Checking the controls

Throttle trigger lockout and throttle trigger

- ▶ Shut off the engine.
- ▶ Attempt to pull the trigger without depressing the lockout lever.
- ▶ If the trigger can be pulled: Do not use your trimmer and contact your STIHL dealer for assistance.
The throttle trigger lockout is defective.
- ▶ Press the throttle trigger lockout and keep pressed.
- ▶ Depress the throttle trigger.
- ▶ Release the throttle trigger and throttle trigger lockout.
- ▶ If the trigger or trigger lockout is stiff or does not spring back to the idle position: Do not use your trimmer and contact your STIHL dealer for assistance.
Trigger or trigger lockout is faulty.

Throttle cable adjustment

- ▶ Start the engine.
- ▶ Attempt to pull the trigger without depressing the lockout lever.
- ▶ If the engine accelerates: Adjust the throttle cable.
Throttle cable adjustment is not correct.

Shut off the engine.

- ▶ Start the engine.
- ▶ Move the slide control to position **STOP-0**.
The engine stops.
- ▶ If the engine does not stop:
 - ▶ Move the choke lever to position **I** and press the throttle trigger.
The engine stops.
 - ▶ Do not use your brushcutter and contact a STIHL servicing dealer for assistance.
The slide control is defective.

11 Operating the Trimmer

11.1 Adjusting Carburetor for Operation at High Altitude

- If you use the trimmer at high altitude, the engine will not deliver optimum power. The carburetor setting can be adjusted to obtain optimum engine power.
- ▶ Start the engine.

- ▶ Warm up the engine by opening and closing the throttle for about 1 minute.

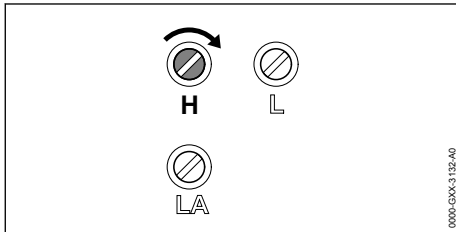

NOTICE

- If the trimmer is again used at a low altitude, the engine may overheat.
 - ▶ Carry out the standard setting.
- ▶ Rotate the high speed screw H clockwise until the engine delivers optimum power.

11.2 Holding and Controlling the Trimmer

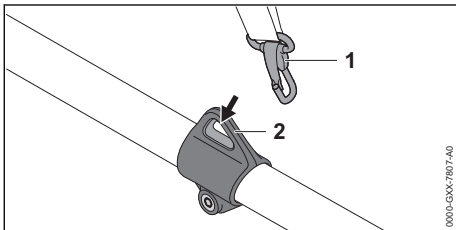

- ▶ Connect the carrying ring (2) to the carabiner (1).

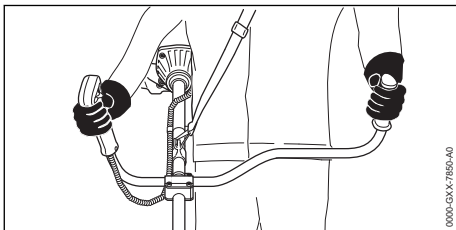

- ▶ Hold the trimmer firmly with your right hand on the control handle – wrap your thumb around the handle.
- ▶ Hold the trimmer firmly with your the left hand on the left handle – wrap your thumb around the handle.

11.3 Mowing

The cutting height is determined by the distance of the cutting attachment from the ground.

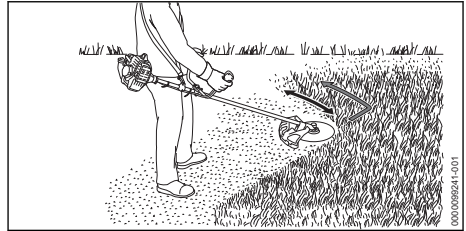

Mowing with a grass cutting blade

- ▶ Mow with the left part of the metal cutting attachment.
- ▶ Move forward slowly in a controlled manner.

12 After Finishing Work

12.1 After Finishing Work

- ▶ Shut off the engine.
- ▶ Allow trimmer to cool down.
- ▶ If the trimmer is wet: Allow the trimmer to dry.
- ▶ Clean the trimmer.
- ▶ Clean the air filter.
- ▶ Clean the deflector.
- ▶ Clean the cutting attachment.
- ▶ If a metal cutting attachment is mounted: Fit the matching transport guard.

13 Transporting

13.1 Transporting the Trimmer

- ▶ Shut off the engine.
- ▶ If a metal cutting attachment is mounted: Fit the matching transport guard.

Carrying the trimmer

- ▶ Carry the trimmer properly balanced by the drive tube with the cutting attachment behind you.

Transporting the trimmer in a vehicle

- ▶ Secure the trimmer to prevent turnover and movement.

14 Storing

14.1 Storing the Brushcutter

- ▶ Shut off the engine.
- ▶ If a metal cutting attachment is mounted: Fit the appropriate transport guard.
- ▶ Ensure that the following conditions are met when storing the brushcutter:
 - The brushcutter is out of the reach of children.
 - The brushcutter is clean and dry.

- ▶ If you store the trimmer for more than 30 days:
 - ▶ Remove the cutting attachment.
 - ▶ Open the fuel tank cap.
 - ▶ Drain the fuel tank.
 - ▶ Close the fuel tank.
 - ▶ If a manual fuel pump is fitted: Press the manual fuel pump at least 5 times.
 - ▶ Start the engine and run it at idling speed until it stops.

15 Cleaning

15.1 Cleaning the Trimmer

- ▶ Shut off the engine.
- ▶ Allow trimmer to cool down.
- ▶ Clean the trimmer with a damp cloth or STIHL resin solvent.
- ▶ Clean cooling air slots with a soft brush.

15.2 Cleaning the Deflector and Cutting Attachment

- ▶ Shut off the engine.
- ▶ Clean the deflector and cutting attachment with a damp cloth or a soft brush.

16 Maintenance

16.1 Maintenance Intervals

The maintenance intervals are dependent on the environmental and operating conditions. STIHL recommends the following maintenance intervals:

After every 50 hours of operation

- ▶ Lubricate the gearbox.

After every 100 hours of operation

- ▶ Install a new spark plug.

Monthly:

- ▶ Have fuel tank cleaned by a STIHL servicing dealer.
- ▶ Have pickup body in fuel tank cleaned by a STIHL servicing dealer.

Every 12 months

- ▶ Have pickup body in fuel tank replaced by a STIHL servicing dealer.

16.2 Lubricating the Gearbox

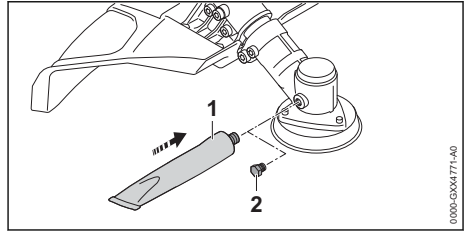

- ▶ Remove screw plug (2).
- ▶ If no grease is visible on the end of the screw plug (2):
 - ▶ Apply tube of "STIHL gear grease" (1) to the filler hole.
 - ▶ Squeeze 5 g of STIHL gear grease into the gear housing.
 - ▶ Insert and tighten the screw plug (2) securely.
 - ▶ Start the engine and run it for one minute at full throttle.
The STIHL gear lubricant is evenly distributed.

16.3 Adjusting the Throttle Cable

- ▶ Start the engine.

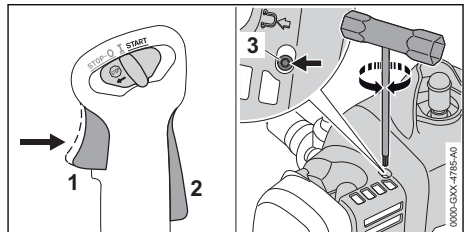

- ▶ Press the throttle trigger (1) without pressing the throttle trigger lockout (2).
- ▶ If the engine accelerates: Hold the throttle trigger (1) depressed and turn screw (3) counterclockwise until there is no further audible drop in engine speed.
The throttle cable had been over-tensioned.
- ▶ Press and hold the throttle trigger (1) without depressing the throttle trigger lockout (2).
- ▶ Turn screw (3) clockwise until the engine accelerates.
- ▶ Turn the screw (3) counterclockwise by 1.5 turns.
The engine runs at idle speed, and the throttle cable adjustment is correct.
- ▶ Shut off the engine.

16.4 Sharpening and Balancing a Metal Cutting Attachment

Correctly sharpening and balancing metal cutting attachments requires a lot of practice.

STIHL recommends you have metal cutting attachments resharpened and balanced by a STIHL servicing dealer.

attachment and contact your STIHL servicing dealer.

17 Repairing

17.1 Repairing the Trimmer and Cutting Attachment

The trimmer and cutting attachment cannot be repaired by the user.

- ▶ If the trimmer or cutting attachment is damaged: Do not use your trimmer or cutting

18 Troubleshooting

18.1 Troubleshooting Trimmer

Most malfunctions have the same causes.

- ▶ Perform the following operations:
 - ▶ Clean the air filter.
 - ▶ Clean or replace the spark plug.
 - ▶ Carry out the standard setting.
 - ▶ Adjust idle speed.
 - ▶ Adjust carburetor for operation at high altitude.
- ▶ If the malfunction still exists: Take the action described in the following table.

Condition	Cause	Remedy
Engine does not start.	Insufficient fuel in the tank.	▶ Prepare fuel mix and refuel the trimmer.
	Engine is flooded.	▶ Clear the combustion chamber.
	Carburetor is too hot.	▶ Allow trimmer to cool down. ▶ Before starting the engine: Depress the manual fuel pump bulb at least ten times.
	Carburetor is iced up.	▶ Allow trimmer to warm up to +10°C.
Engine idles erratically.	Carburetor is iced up.	▶ Allow trimmer to warm up to +10°C.
Engine stops while idling	Carburetor is iced up.	▶ Allow trimmer to warm up to +10°C.

18.2 Cleaning the Air Filter

- ▶ Shut off the engine.

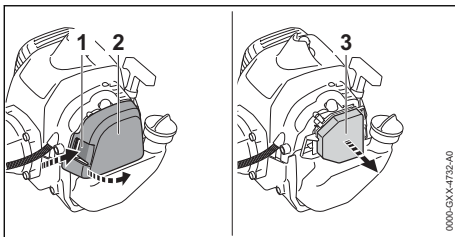

- ▶ Depress the locking tab (1) and remove the filter cover (2).
- ▶ Clean the area around the air filter (3) with a damp cloth or a soft brush.
- ▶ Take out the air filter (3).
- ▶ Tap the air filter (3).
- ▶ If the air filter (3) is damaged: Install a new air filter (3).
- ▶ Wash the air filter (3) in warm, soapy water.
- ▶ Rinse the air filter (3) under running water.
- ▶ Allow the air filter (3) to dry in the air.
- ▶ Evenly spread 5 ml two-stroke engine oil in the air filter (3).

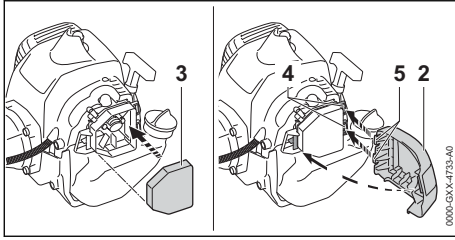

- ▶ Insert air filter (3).
- ▶ Position the filter cover (2) so that the locking tabs (5) engage with the recesses (4).
- ▶ Close the filter cover (2).
The filter cover (2) engages in position with an audible click.

18.3 Cleaning the Spark Plug

- ▶ Shut off the engine.
- ▶ Allow trimmer to cool down.

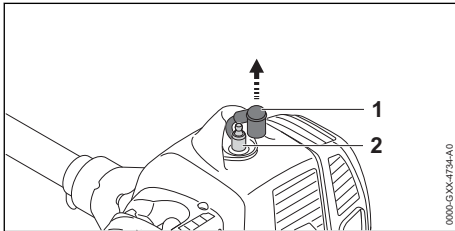

- ▶ Pull off the spark plug boot (1).
- ▶ If the area around the spark plug (2) is soiled: Clean the spark plug (2) with a cloth.
- ▶ Unscrew the spark plug (2).
- ▶ Clean the spark plug (2) with a cloth.
- ▶ If the spark plug (2) is corroded: Install a new spark plug (2).
- ▶ Insert and tighten down the spark plug (2) firmly.
- ▶ Press the spark plug boot (1) firmly home.

18.4 Adjusting standard setting

- ▶ Shut off the engine.

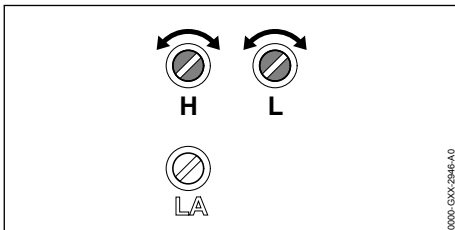

- ▶ Turn the high speed screw H counterclockwise up to the limit stop.

- ▶ Turn the high speed screw H 1 1/2 turns counterclockwise.
- ▶ Turn the low speed screw L clockwise as far as it will go.
- ▶ Turn the low speed screw L one turn counterclockwise.

18.5 Adjusting Idle Speed

- ▶ Carry out the standard setting.
- ▶ Start the engine.
- ▶ Warm up the engine by opening and closing the throttle for about 1 minute.

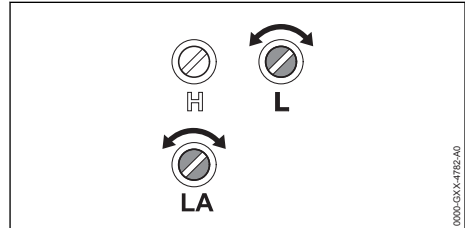

Engine stops while idling

- ▶ Turn the idle speed screw (LA) clockwise until the cutting attachment begins to rotate.
- ▶ Turn the idle speed screw (LA) one full turn counterclockwise.

Erratic idling behavior or poor acceleration

- ▶ Turn the low speed screw (L) clockwise or counterclockwise until the engine runs and accelerates smoothly.

Cutting attachment rotates when engine is idling

- ▶ Turn the idle speed screw (LA) counterclockwise until the cutting attachment stops rotating.
- ▶ Turn the idle speed screw (LA) one full turn counterclockwise.

18.6 Clearing the Combustion Chamber

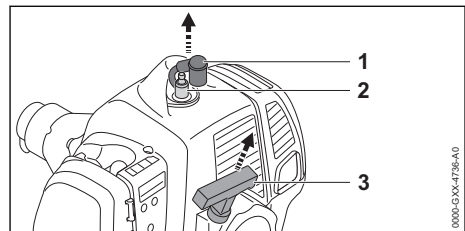

- ▶ Pull off the spark plug boot (1).
- ▶ Unscrew the spark plug (2).
- ▶ Dry the spark plug (2).

 **WARNING**

■ Unconfined sparks may occur if the starter grip is pulled after the spark plug boot has been removed. Sparks may cause a fire or an explosion in an easily combustible or explosive environment. This can result in serious or fatal injuries and damage to property.

- ▶ Move the slide control to position **STOP-0** before pulling the starter grip.

- ▶ Move the slide control to position .
- ▶ Pull the starter grip (3) several times and guide it back slowly.
The combustion chamber is cleared.
- ▶ Insert and tighten down the spark plug (2) firmly.

- ▶ Connect the spark plug boot (1) and press it down firmly.

19 Specifications

19.1 STIHL FS 230 Trimmer

- Displacement: 40.2 cm³
- Engine power: 1.55 kW (2.1 hp) at 8500 rpm
- Idle speed: 2800 rpm
- Maximum output shaft speed: 8,900 rpm
- Approved spark plug: Bosch WSR 6 F from STIHL
- Electrode gap of the spark plug: 0.5 mm
- Dry weight without cutting attachment and deflector: 7.2 kg
- Length without cutting tool: 1824 mm
- Max. fuel tank capacity: 810 cm³ (0.81 l)

20 Combinations of Cutting Attachments, Deflectors and Carrying Systems

20.1 Combinations of Cutting Attachments, Deflectors and Carrying Systems

Cutting attachment	Deflector	Carrying system
– Grass cutting blade 305-2 (Ø 305 mm)	– Universal deflector without skirt	– Shoulder strap – Full harness with quick-release system

21 Spare Parts and Accessories

21.1 Spare parts and accessories

STIHL  These symbols indicate original STIHL spare parts and original STIHL accessories.

STIHL recommends the use of original STIHL spare parts and accessories.

Despite ongoing market observation, STIHL is unable to judge the reliability, safety and suitability of other manufacturers' spare parts and accessories; accordingly, STIHL cannot warrant for the use of those parts.

Original STIHL spare parts and original STIHL accessories are available from STIHL dealers.

- ▶ Do not dispose with domestic waste.

22 Disposal

22.1 Disposing of the Brushcutter

Contact the local authorities or your STIHL dealer for information on disposal.

Improper disposal can be harmful to health and pollute the environment.

- ▶ Take STIHL products including packaging to a suitable collection point for recycling in accordance with local regulations.

www.stihl.com



0458-733-0121-C



0458-733-0121-C