

STIHL BGA 57

***STIHL***



2 - 17      Instruction Manual



## Contents

1	Introduction.....	2
2	Guide to Using this Manual.....	2
3	Overview.....	3
4	Safety Precautions.....	3
5	Preparing the Blower for Operation.....	10
6	Charging the Battery, LEDs.....	10
7	Assembling the Blower.....	11
8	Removing and Fitting the Battery.....	11
9	Switching the Blower On/Off.....	12
10	Testing the Blower and Battery.....	12
11	Operating the Blower.....	12
12	After Finishing Work.....	13
13	Transporting.....	13
14	Storing.....	13
15	Cleaning.....	14
16	Maintenance and Repairs.....	14
17	Troubleshooting.....	14
18	Specifications.....	15
19	Spare Parts and Accessories.....	16
20	Disposal.....	16
21	EC Declaration of Conformity.....	16

## 1 Introduction

Dear Customer,

Thank you for choosing STIHL. We develop and manufacture our quality products to meet our customers' requirements. The products are designed for reliability even under extreme conditions.

STIHL also stands for premium service quality. Our dealers guarantee competent advice and instruction as well as comprehensive service support.

STIHL expressly commit themselves to a sustainable and responsible handling of natural resources. This user manual is intended to help you use your STIHL product safely and in an environmentally friendly manner over a long service life.

We thank you for your confidence in us and hope you will enjoy working with your STIHL product.



Dr. Nikolas Stihl

**IMPORTANT! READ BEFORE USING AND  
KEEP IN A SAFE PLACE FOR REFERENCE.**

## 2 Guide to Using this Manual

### 2.1 Applicable Documentation

Local safety regulations apply.

- ▶ Read, understand and save the following documents in addition to this instruction manual:
  - Safety notes and precautions for STIHL AK battery.
  - Safety information for STIHL batteries and products with built in batteries:  
www.stihl.com/safety-data-sheets

### 2.2 Symbols used with warnings in the text



- This symbol indicates dangers that can cause serious injuries or death.
  - ▶ The measures indicated can avoid serious injuries or death.



- This symbol indicates dangers that can cause damage to property.
  - ▶ The measures indicated can avoid damage to property.

### 2.3 Symbols in Text



This symbol refers to a chapter in this instruction manual.

## 3 Overview

### 3.1 Blower, Battery and Charger

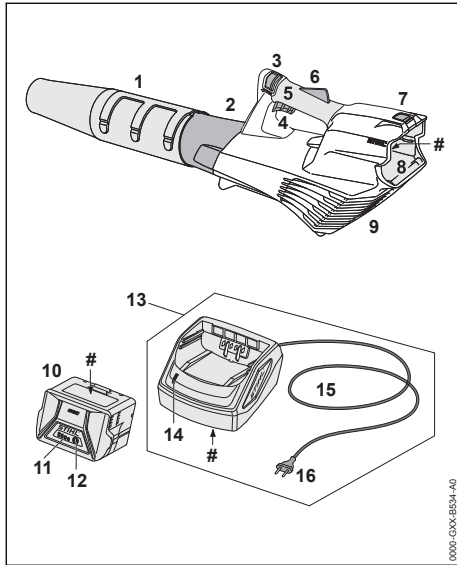

- 1 Nozzle**  
Directs and concentrates the airstream.
- 2 Blower Tube**  
Directs the airstream.
- 3 Release Slide**  
Operated together with the trigger lockout to unlock the trigger.
- 4 Trigger**  
The trigger switches the blower on and off.
- 5 Control Handle**  
For operating, controlling and carrying the blower.
- 6 Trigger Lockout**  
Unlocks the trigger.
- 7 Locking Lever**  
Holds the battery in the battery compartment.
- 8 Battery Compartment**  
Accommodates the battery.
- 9 Intake Screen**  
Protects the operator from moving parts inside the blower.
- 10 Battery**  
Supplies power to the blower.
- 11 LEDs**  
Indicate battery's state of charge and malfunctions.

#### 12 Button

Activates the LEDs on the battery.

#### 13 Charger

Charges the battery.

#### 14 LED

The LED indicates the operating status of the charger.

#### 15 Connecting Cable

Connects charger to appliance plug.

#### 16 Appliance Plug

Connects cable to wall outlet.

#### # Rating Label with Serial Number

### 3.2 Symbols

Meanings of symbols that may be on the blower, battery and charger:



1 LED glows red. Battery too hot or too cold.



4 LEDs flash red. There is a malfunction in the battery.



LED glows green and LEDs on battery glow or flash green. Battery is being charged.



LED flashes red. No electrical contact between battery and charger or malfunction in battery or charger.



Guaranteed sound power level according to directive 2000/14/EC in dB(A) in order to make sound emissions of products comparable.



The data next to this symbol indicates the energy content of the battery according to the cell manufacturer's specification. The energy content available during operation is lower.



Operate the electric appliance in a dry place, indoors only.



Do not dispose of the product with your household waste.

## 4 Safety Precautions

### 4.1 Warning Symbols

Meanings of warning signs and labels on the blower, battery or charger:



Observe safety notices and take the necessary precautions.



Read, understand and save the instruction manual.



Wear safety glasses.



Confine long hair so that it cannot be sucked into the blower.



Always remove the battery during work breaks, transport, storage, maintenance or repairs.



Protect blower and charger from rain and dampness.



Maintain safe distance.



Protect battery from heat and fire.



Protect the battery from rain and damp – do not immerse it in fluids.



Observe battery's permissible temperature range.

## 4.2 Intended Use

The STIHL BGA 57 blower is designed for blow-sweeping leaves, grass, paper and similar matter.

Do not use the blower in the rain.

The STIHL AK battery supplies power to the blower.

The STIHL AL 101 charger recharges the STIHL AK battery.

## ▲ WARNING

- Batteries and chargers not explicitly approved for the blower by STIHL may cause a fire or explosion. This can result in serious or fatal injuries and damage to property.
  - ▶ Use the blower with a STIHL AK battery.

- ▶ Recharge the STIHL AK battery with a STIHL AL 101, AL 300 or AL 500 charger.

- Using the blower, battery or the charger for purposes for which they were not designed may result in serious or fatal injuries and damage to property may occur.
  - ▶ Use the blower, battery and charger as described in this instruction manual.

## 4.3 The Operator

### ▲ WARNING

- Users without adequate training or instruction cannot recognize or assess the risks involved in using the blower, battery and charger. The user or other persons may sustain serious or fatal injuries.



- ▶ Read, understand and save the instruction manual.

- ▶ If you pass the blower, battery or the charger on to another person: Always give them the instruction manual.
- ▶ Make sure the user meets the following requirements:
  - The user must be rested.
  - The user must be in good physical condition and mental health to operate and work with the blower, battery and charger. If the user's physical, sensory or mental ability is restricted, he or she may work only under the supervision of or as instructed by a responsible person.
  - The user is able to recognize and assess the risks involved in using the blower, battery and charger.
  - The user must be of legal age or is being trained in a trade under supervision in

accordance with national rules and regulations.

- The user has received instruction from a STIHL servicing dealer or other experienced user before working with the blower for the first time.
  - The user must not be under the influence of alcohol, medication or drugs.
- ▶ If you have any queries: Contact your STIHL servicing dealer for assistance.

#### 4.4 Clothing and Equipment

##### ▲ WARNING

- Long hair can be sucked into the blower during operation. This can result in serious injuries.



- ▶ Tie up long hair so that it is above shoulder level.

- Objects can be thrown through the air at high speed during operation. This can result in personal injury.



- ▶ Wear close-fitting safety glasses. Suitable glasses that have been tested and labeled in accordance with EN 166 or national standards are available from retailers.

- ▶ Wear long trousers.
- Dust can be whipped up during operation: Whipped up dust can damage the respiratory passages and cause allergic reactions.
  - ▶ If dust is generated: Wear a dust respirator mask.
- Unsuitable clothing can snag on wood, brush or the blower. Not wearing suitable clothing may result in serious injury.
  - ▶ Wear snug-fitting clothing.
  - ▶ Do not wear a scarf or jewelry.
- Wearing unsuitable footwear may cause you to slip or stumble. This can result in personal injury.
  - ▶ Wear sturdy enclosed footwear with non-slip soles.

#### 4.5 Work Area and Surroundings

##### 4.5.1 Blower

##### ▲ WARNING

- Bystanders, children and animals are not aware of the dangers of the blower and objects being thrown into the air and cannot assess them. This may result in serious injury to bystanders, children and animals and damage to property.



- ▶ Do not allow bystanders, children or animals within 5 meters of the work area.

- ▶ Maintain a clearance of 5 meters from objects.
- ▶ Do not leave the blower unattended.
- ▶ Ensure that children cannot play with the blower.
- The blower is not waterproof. If you work in the rain or in a damp environment, an electric shock may occur. This can result in injuries to the user and may damage the blower.



- ▶ Do not work in the rain or in a damp environment.

- Electrical components of the blower can produce sparks. Sparks may cause fires and explosions in highly flammable or explosive environments. Persons may be seriously or fatally injured and property may be damaged.
  - ▶ Do not work in a highly flammable or explosive environment.

##### 4.5.2 Battery

##### ▲ WARNING

- Bystanders, children and animals cannot recognize or assess the dangers of the battery. Bystanders, children and animals may be seriously injured.
  - ▶ Keep bystanders, children and animals away from the work area.
  - ▶ Do not leave the battery unattended.
  - ▶ Make sure that children cannot play with the battery.
- The battery is not protected against all ambient conditions. If the battery is exposed to certain ambient conditions, it may catch fire or explode. This can result in serious injuries and damage to property.



- ▶ Protect battery from heat and fire.
- ▶ Do not throw the battery into a fire.



- ▶ Use and store the battery at temperatures between - 10 °C and + 50 °C.



- ▶ Protect the battery from rain and damp – do not immerse it in fluids.
- ▶ Keep battery away from metallic objects.
- ▶ Do not expose battery to high pressure.
- ▶ Do not expose battery to microwaves.
- ▶ Protect battery from chemicals and salts.

#### 4.5.3 Charger

### ▲ WARNING

- Bystanders, children and animals are not aware of and cannot assess the dangers of a charger or electric current. Bystanders, children and animals may be seriously or fatally injured.
  - ▶ Keep bystanders, children and animals away from the work area.
- ▶ **Make sure that children cannot play with the charger.**
- The charger is not waterproof. If you work in the rain or in a damp environment, an electric shock may occur. The user may be injured and the charger may be damaged.



- ▶ Do not operate it in the rain or in a damp environment.

- The charger is not protected against all ambient conditions. If the charger is exposed to certain ambient conditions, it may catch fire or explode. This may result in serious injury to people and damage to property.
  - ▶ Operate the charger in an enclosed, dry room.
  - ▶ Do not operate the charger in a flammable environment or in an explosive environment.
  - ▶ Do not operate the charger on a readily combustible surface.
  - ▶ Use and store the charger at temperatures between + 5 °C and + 40 °C.
- The connecting cable is a trip hazard. People may be injured and the charger may be damaged.
  - ▶ Lay the connecting cable flat on the floor.

## 4.6 Safe Condition

### 4.6.1 Blower

The blower is in a safe condition if the following conditions are fulfilled:

- The blower is undamaged.
- Blower must be clean and dry.
- The controls function properly and have not been modified.
- Original STIHL accessories are fitted.
- The accessories are correctly attached.

### ▲ WARNING

- If not in safe condition, components may no longer operate correctly and safety devices may be disabled. This may result in serious or fatal injury to people.
  - ▶ Never use a damaged blower.
  - ▶ If the blower is dirty or wet: Clean the blower and allow it to dry.
  - ▶ Do not modify the blower. Exception: Mounting a nozzle approved for this blower model.
  - ▶ If the controls do not function properly: Do not work with the blower.
  - ▶ Fit original STIHL accessories designed for this blower model.
  - ▶ Attach accessories as described in this User Manual or in the User Manual for the accessories.
  - ▶ Do not insert objects into the openings in the blower.
  - ▶ Replace worn or damaged labels.
  - ▶ If you have any doubts, be sure to consult a STIHL dealer.

### 4.6.2 Battery

The battery is in safe condition when the following conditions are met:

- The battery is not damaged.
- The battery is clean and dry.
- The battery is working and has not been modified.

### ▲ WARNING

- The battery cannot function safely if it is not in safe condition. There is a risk of serious injury to persons.
  - ▶ Use an undamaged and functioning battery.
  - ▶ Do not charge a damaged or defective battery.
  - ▶ If the battery is dirty or wet: clean the battery and allow it to dry.
  - ▶ Do not modify the battery.
  - ▶ Do not insert objects into the apertures in the battery.

- ▶ Never connect the battery terminals to metallic objects and cause a short circuit.
- ▶ Do not open the battery.
- ▶ Replace worn or damaged warning signs.
- Fluid may leak from a damaged battery. If the fluid contacts the skin or eyes, this may cause irritation.
  - ▶ Avoid contact with the fluid.
  - ▶ In the event of contact with the skin: wash the affected areas with plenty of soap and water.
  - ▶ In the event of contact with the eyes: rinse the eyes with plenty of water for at least 15 minutes and seek medical attention.
- A damaged or defective battery may emit an unusual odour, smoke or catch fire. This may result in serious or fatal injury to people and damage to property.
  - ▶ If the battery emits an unusual odour or smoke: do not use the battery and keep it away from flammable materials.
  - ▶ If the battery catches fire: try to extinguish the battery using a fire extinguisher or water.

#### 4.6.3 Charger

The charger is in a safe condition if the following points are observed:

- Charger is undamaged.
- Charger is clean and dry.

### ▲ WARNING

- If components do not comply with safety requirements, they will no longer function properly and safety devices may be rendered inoperative. This can result in serious or fatal injuries.
  - ▶ Do not use a damaged charger.
  - ▶ If the charger is dirty or wet: Clean the charger and allow it to dry.
  - ▶ Never attempt to modify the charger.
  - ▶ Never insert objects in the charger's openings.
  - ▶ Never bridge the charger's contacts with metallic objects (short circuit).
  - ▶ Do not open the charger.

#### 4.7 Operation

### ▲ WARNING

- The user cannot concentrate on the work in certain situations. The user may stumble, fall and be seriously injured.
  - ▶ Work calmly and carefully.
  - ▶ If light and visibility are poor: Do not work with the blower.

- ▶ Operate the blower alone.
- ▶ Do not work above shoulder height.
- ▶ Watch out for obstacles.
- ▶ Stand on the ground while working and keep a good balance. If it is necessary to work at heights: Use a lift bucket or a safe platform.
  - ▶ If you begin to feel tired: Take a break.
  - ▶ Blow sweep with the wind.
- Objects can be thrown through the air at high speed during operation. Bystanders and animals may be injured and damage to property may occur.
  - ▶ Do not direct the air blast towards bystanders, animals or objects.
- If the behavior of the blower changes during operation or feels unusual, it may no longer be in a safe condition. This can result in serious injuries and damage to property.
  - ▶ Stop work, remove the battery and contact your STIHL servicing dealer for assistance.
- Blower vibrations may occur during operation.
  - ▶ Take regular breaks.
  - ▶ If signs of circulation problems occur: Seek medical advice.
- The dust whipped up may cause the blower to be electrostatically charged. In certain conditions (e.g. dry environment) the blower may discharge suddenly and emit sparks. Sparks may cause a fire or an explosion in an easily combustible or explosive environment. This can result in serious or fatal injuries and damage to property.
  - ▶ Do not work in an easily combustible or explosive environment.

#### 4.8 Charging

### ▲ WARNING

- A damaged or defective charger may produce an unusual smell or emit smoke during the charging process. This may result in personal injuries and damage to property.
  - ▶ Disconnect the plug from the wall outlet.
- The charger can overheat and cause a fire if heat dissipation is inadequate. This can result in serious or fatal injuries and damage to property.
  - ▶ Do not cover the charger.



#### 4.9 Connecting to Power Supply

Contact with live components may occur for the following reasons:

- The connecting cable or extension cable is damaged.

- Connecting cable plug or extension cable is damaged.
- Wall outlet is not properly installed.

## **⚠ DANGER**

- Contact with live components can result in an electric shock. This can result in serious or fatal injuries.
  - ▶ Check that the connecting cable, extension cable and their plugs are not damaged.
- 
 If the connecting cable or extension cable is damaged:
  - ▶ Do not touch damaged areas.
  - ▶ Disconnect the plug from the wall outlet.
- ▶ Never touch the connecting cable, extension cable or their plugs with wet hands.
- ▶ Insert the plug of the connecting cable or extension cable in a properly installed fused wall outlet with ground contact.
- ▶ Install the charger with a ground fault circuit interrupter (30 mA, 30 ms).
- A damaged or unsuitable extension cable can cause an electric shock. This can result in serious or fatal injuries.
  - ▶ Use an extension cable with the correct wire gauge,  18.4.

## **⚠ WARNING**

- Overvoltage can occur in the charger if the line voltage or frequency are incorrect during charging. The charger may be damaged.
  - ▶ Make sure the line voltage and frequency agree with the data on the charger's rating plate.
- A carelessly laid connecting or extension cable can be damaged and cause others to trip or fall. This can result in injuries and may damage the connecting cable or extension cable.
  - ▶ Position and mark connecting cable and extension cable so they do not represent a trip hazard.
  - ▶ Position the connecting and extension cables so that they are not under tension or entangled.
  - ▶ Position the connecting and extension cables so that they cannot be damaged, kinked, pinched or chafed.
  - ▶ Protect the connecting cable and extension cable from heat, oil and chemicals.
  - ▶ Lay the connecting and extension cables on a dry surface.
- The extension cable becomes hot during operation. If the heat cannot dissipate, it may cause a fire.

- ▶ If you use a cable drum: Unwind the extension cable to its full length.
- If electric cables or pipes are embedded in the wall, they may be damaged when the charger is mounted on a wall. Contact with electric cables can result in an electric shock. This can result in serious injuries and damage to property.
  - ▶ Check that there are no electric cables or pipes embedded in the wall.
- If the charger is not mounted on the wall as described in this instruction manual, the charger or the battery may fall down or the charger may overheat. This may result in personal injuries and damage to property.
  - ▶ Mount the charger on the wall as described in this instruction manual.
- If the charger is mounted on a wall with the battery inserted, the battery may fall out and be damaged. This may result in personal injuries and damage to property.
  - ▶ Mount the charger on the wall first and then insert the battery.

## 4.10 Transporting

### 4.10.1 Blower

## **⚠ WARNING**

- The blower can turn over or move while being transported. This may result in personal injuries and damage to property.



- ▶ Remove the battery.
- ▶ Secure the blower with lashing straps or a net to prevent it turning over and moving.

### 4.10.2 Battery

## **⚠ WARNING**

- The battery is not protected against all ambient conditions. The battery may be damaged if it is exposed to certain ambient conditions and damage to property may occur.
  - ▶ Never transport a damaged battery.
  - ▶ Store the battery in non-conductive packaging.
- The battery may turn over or shift during transport. This may result in personal injuries and damage to property.
  - ▶ Pack the battery in packaging in such a way that it cannot move.
  - ▶ Secure the packaging so that it cannot move.



### 4.10.3 Charger

## ⚠ WARNING

- The charger may turn over or move while being transported. This may result in personal injuries and damage to property.
  - ▶ Disconnect the plug from the wall outlet.
  - ▶ Remove the battery.
  - ▶ Secure the charger with lashing straps, belts or a net to prevent it turning over and moving.
- The connecting cable must not be used for carrying the charger. The connecting cable and the charger may be damaged.
  - ▶ Wind up the connecting cable and attach it to the charger.

## 4.11 Storing

### 4.11.1 Blower

## ⚠ WARNING

- Children are not aware of and cannot assess the dangers of a blower and can be seriously injured.



- ▶ Remove the battery.

- ▶ Store the blower out of the reach of children.

- Dampness can corrode the electrical contacts on the blower and metal components. The blower may be damaged.



- ▶ Remove the battery.

- ▶ Store the blower in a clean and dry condition.

### 4.11.2 Battery

## ⚠ WARNING

- Children are not aware of and cannot assess the dangers of the battery and can be seriously injured.
  - ▶ Store the battery out of the reach of children.
- The battery is not protected against all ambient conditions. The battery may be damaged if it is exposed to certain ambient conditions.
  - ▶ Store the battery in a clean and dry condition.
  - ▶ Store the battery in a confined space.
  - ▶ Store the battery separately from the blower and charger.

- ▶ Store the battery in non-conductive packaging.
- ▶ Use and store the battery at temperatures between -10°C and +50°C.

### 4.11.3 Charger

## ⚠ WARNING

- Children are not aware of and cannot assess the dangers of a charger. Children may sustain serious or fatal injuries.
  - ▶ Remove the battery.
  - ▶ Store the charger out of the reach of children.
- The charger is not protected against all ambient conditions. The charger may be damaged if it is exposed to certain ambient conditions.
  - ▶ Remove the battery.
  - ▶ If the charger is hot: Allow charger to cool down.
  - ▶ Store the charger in a clean and dry condition.
  - ▶ Store the charger in an enclosed location.
  - ▶ Store the charger at a temperature between +5°C and +40°C.
- The connecting cable must not be used for carrying or hanging up the charger. The connecting cable and the charger may be damaged.
  - ▶ Hold the charger by the housing. A recessed handle is provided on the back of the charger.
  - ▶ Hang the charger on the wall bracket.

## 4.12 Cleaning, Maintenance and Repair

## ⚠ WARNING

- If the battery is inserted when carrying out cleaning, servicing or repairs, it is possible for the blower to be switched on unintentionally. This may result in serious injury to people and damage to property.



- ▶ Remove the battery.









- Sharp cleaning agents, cleaning with a water jet or pointed objects can damage the blower, the battery and the charger. If the blower, battery or charger are not cleaned as described in this instruction manual, components may no longer function properly or safety devices may be rendered inoperative. They may cause serious injury to persons.

- ▶ Clean the blower, battery and charger as described in this instruction manual.
- If the blower, battery or charge are not serviced or repaired correctly, components may no longer function properly or safety devices may be rendered inoperative. This may result in serious or fatal injury to people.
  - ▶ Do not attempt to service or repair the blower, battery or charger.
  - ▶ If the blower, battery or the charger require servicing or repairs: Contact your STIHL servicing dealer for assistance.

## 5 Preparing the Blower for Operation

### 5.1 Preparing the Blower for Operation

Perform the following steps before starting work:

- ▶ Make sure the following components are in a safe condition:
  - Blower,  4.6.1.
  - Battery,  4.6.2.
  - Charger,  4.6.3.
- ▶ Check the battery,  10.2.
- ▶ Fully charge the battery,  6.2.
- ▶ Clean the blower,  15.1.
- ▶ Mount the nozzle,  7.1.
- ▶ Check the controls,  10.1.
  - ▶ If 3 LEDs flash red while you are checking the controls: Remove the battery and contact your STIHL servicing dealer. Malfunction in blower.
- ▶ If you cannot carry out this work: Do not use the blower and contact your STIHL servicing dealer.

## 6 Charging the Battery, LEDs

### 6.1 Mounting the Charger on a Wall

The charger can be mounted on a wall.

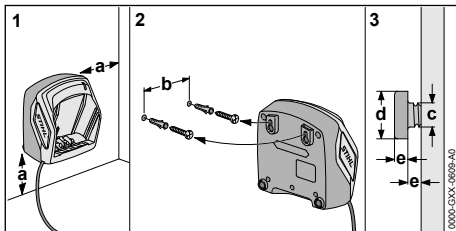

### ▶ Check the following points when mounting the charger on a wall:

- Suitable fixing materials.
- The charger is level.
  - The following dimensions are maintained:
    - a = at least 100 mm
    - b (for AL 101) = 75 mm
    - b (for AL 300 and AL 500) = 120 mm
    - c = 4.5 mm
    - d = 9 mm
    - e = 2.5 mm

### 6.2 Charging the Battery

The charging time depends on several factors, e.g. temperature of the battery or the ambient temperature. The actual charging time may differ from the specified charging time. For specified charging times see [www.stihl.com/charging-times](http://www.stihl.com/charging-times).

The charging process starts automatically when the plug is inserted in a wall outlet and the battery is fitted in the charger. The charger switches itself off automatically when the battery is fully charged.

The battery and charger become hot during the charging process.

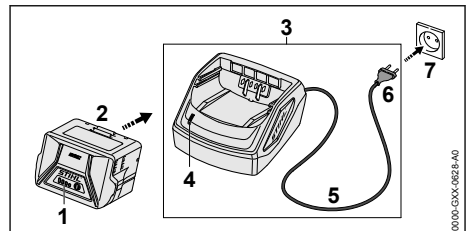

- ▶ Insert the plug (6) in a convenient wall outlet (7).
  - The charger (3) runs a self test. The LED (4) glows green for about 1 second and then red for about 1 second.
- ▶ Fit the connecting cable (5).
- ▶ Insert the battery (2) in the guides in the charger (3) and press it home as far as stop. The LED (4) glows green. The LEDs (1) glow green and the battery (2) is being charged.

- ▶ If the LED (4) and the LEDs (1) stop glowing: The battery (2) is fully charged and can be taken out of the charger (3).
- ▶ If the charger (3) is no longer required. Disconnect the plug (6) from the wall outlet (7).

### 6.3 State of Charge

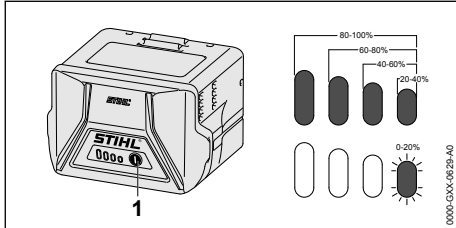

- ▶ Press the button (1). The LEDs (5) glow green for about 5 seconds and indicate the state of charge.
- ▶ If the LED on the right flashes green: Charge the battery.

### 6.4 LEDs on Battery

The LEDs can show the state of charge or malfunctions. The LEDs can glow or flash green or red.

The state of charge is indicated when the LEDs glow or flash green.

- ▶ If the LEDs glow or flash red: Troubleshooting,  17.1. Malfunction in blower or battery.

### 6.5 LED on Charger

The LED indicates the operating status of the charger.

If the LED glows green, the battery is being charged.

- ▶ If the LED flashes red: Rectify the malfunction. Malfunction in charger.

## 7 Assembling the Blower

### 7.1 Mounting, Adjusting and Removing the Nozzle

The nozzle can be mounted to the blower tube in three positions to suit the height and reach of the user. The positions are marked on the blower tube.

- ▶ Switch off the blower and remove the battery.

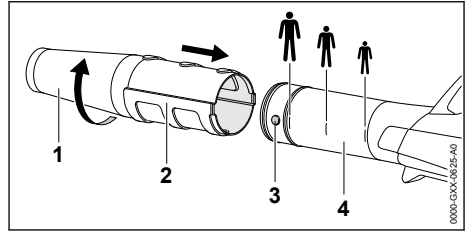

- ▶ Line up the lug (3) and the slot (2).
- ▶ Push nozzle (1) into required position on blower tube (4).
- ▶ Rotate nozzle (1) until it engages.

## 8 Removing and Fitting the Battery

### 8.1 Fitting the Battery

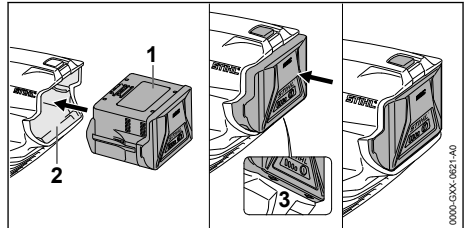

- ▶ Insert the battery (1) in the battery compartment (2) and press it home until you hear a click. Arrows (3) on battery (1) are still visible and battery (1) is held securely in battery compartment (2). There is no electrical contact between blower and battery (1).
- ▶ Push the battery (1) into the battery compartment (2) as far as stop. The battery (1) engages with a second click and is flush with the blower's housing.

### 8.2 Removing the Battery

- ▶ Stand the blower on a level surface.
- ▶ Hold one hand in front of the battery compartment to ensure the battery (2) does not fall out.

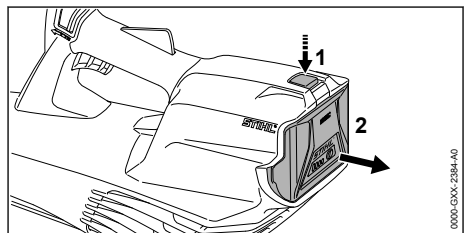

- ▶ Press the locking lever (1) with your other hand.  
The battery (2) is unlocked and can be removed.

## 9 Switching the Blower On/Off

### 9.1 Switching On

- ▶ Hold the blower with one hand on the control handle - wrap your thumb around the handle.

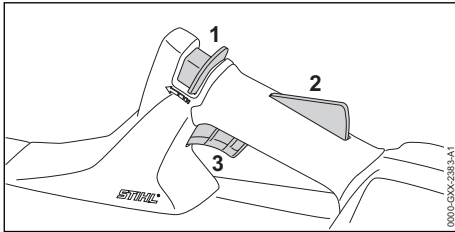

- ▶ Push the release slide (1) in the direction of the blower tube with your thumb and hold it there.
- ▶ Depress the trigger lockout (2) with your hand and hold it there.  
You can let go of the release slide (1).
- ▶ Pull the trigger (3) with your index finger and hold it there.  
The blower accelerates and air flows from the nozzle.

### 9.2 Switching Off

- ▶ Release the trigger and trigger lockout lever.  
No air flows from the nozzle.
- ▶ If air continues to flow from the nozzle:  
Remove the battery and contact your STIHL servicing dealer for assistance.  
Blower has a malfunction.

## 10 Testing the Blower and Battery

### 10.1 Checking the Controls

#### Release slide, trigger lockout and trigger

- ▶ Remove the battery.
- ▶ Attempt to pull the trigger lever without depressing the release slide and the trigger lockout.
- ▶ If the trigger can be pulled: Do not use the blower and contact your STIHL servicing dealer for assistance.  
Release slide or trigger lockout is faulty.
- ▶ Push the release slide in the direction of the blower tube with your thumb and hold it there.

- ▶ Depress the trigger lockout lever and hold it in that position.
- ▶ Pull the trigger.
- ▶ Let go of the trigger, trigger lockout and release slide.
- ▶ If the trigger, trigger lockout or release slide is stiff or does not spring back to the idle position: Do not use the blower and contact your STIHL servicing dealer for assistance.  
The trigger, trigger lockout or release slide has a malfunction.

#### Switching on the blower

- ▶ Fit the battery.
- ▶ Push the release slide in the direction of the blower tube with your thumb and hold it there.
- ▶ Depress the trigger lockout lever and hold it in that position.
- ▶ Pull the trigger and hold it there.  
Air flows from the nozzle.
- ▶ If 3 LEDs flash red: Remove the battery and contact your STIHL dealer for assistance.  
There is a malfunction in the blower.
- ▶ Release the trigger.  
No air flows from the nozzle.
- ▶ If air continues to flow from the nozzle:  
Remove the battery and contact your STIHL dealer for assistance.  
Blower has a malfunction.

### 10.2 Testing the Battery

- ▶ Press button on battery.  
The LEDs glow or flash.
- ▶ If the LEDs do not glow or flash: Do not use the battery and contact your STIHL servicing dealer.  
There is a malfunction in the battery.

## 11 Operating the Blower

### 11.1 Holding and Controlling the Blower

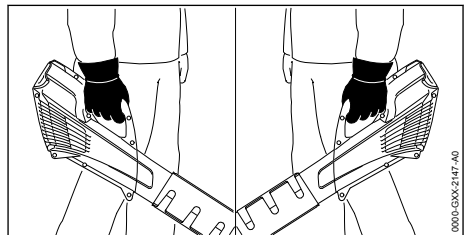

- ▶ Hold and control the blower with one hand on the control handle - wrap your thumb around the handle.

## 11.2 Blow-Sweeping

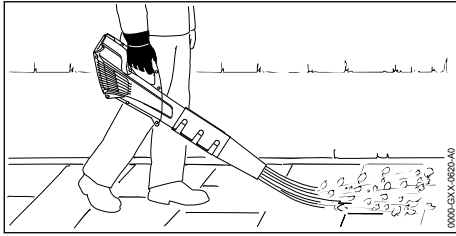

- ▶ Point the nozzle at the ground.
- ▶ Walk slowly and steadily forwards.

## 12 After Finishing Work

### 12.1 After Finishing Work

- ▶ Switch off the blower and remove the battery.
- ▶ If the blower is wet: Allow the blower to dry.
- ▶ If the battery is wet: Allow the battery to dry.
- ▶ Clean the blower.
- ▶ Clean the battery.

## 13 Transporting

### 13.1 Transporting the Blower

- ▶ Switch off the blower and remove the battery.

#### Carrying the Blower

- ▶ Carry the blower by the control handle.

#### Transporting the Blower in Vehicles

- ▶ Secure the blower to prevent turnover and movement.

### 13.2 Transporting the Battery

- ▶ Switch off the blower and remove the battery.
- ▶ Make sure the battery is in a safe condition.
- ▶ Observe the following points when packing the battery:
  - The packaging must be non-conductive.
  - Make sure the battery cannot shift inside the packaging.
- ▶ Secure the packaging so that it cannot move.

The battery is subject to the requirements for the transport of dangerous goods. The battery is classified as UN 3480 (lithium-ion batteries) and has been tested in accordance with UN Manual of Tests and Criteria, Part III, sub-section 38.3.

For transport regulations see [www.stihl.com/safety-data-sheets](http://www.stihl.com/safety-data-sheets)

### 13.3 Transporting the Charger

- ▶ Disconnect the plug from the wall outlet.
- ▶ Remove the battery.

- ▶ Wind up the connecting cable and attach it to the charger.
- ▶ Transporting the charger in a vehicle: Secure the charger with lashing straps, belts or a net to prevent it turning over and moving.

## 14 Storing

### 14.1 Storing the Blower

- ▶ Switch off the blower and remove the battery.
- ▶ Observe the following points when storing the blower:
  - Blower is out of the reach of children.
  - Blower is clean and dry.

### 14.2 Storing the Battery

STIHL recommends that you store the battery with a charge between 40% and 60% (2 LEDs glow green).

- ▶ Observe the following points when storing the battery:
  - Battery is out of the reach of children.
  - Battery is clean and dry.
  - Battery is in an enclosed space.
  - Battery is stored separately, away from the blower and charger.
  - Battery is in non-conductive packaging.
  - Battery is in a temperature range between  $-10^{\circ}\text{C}$  and  $+50^{\circ}\text{C}$ .

### 14.3 Storing the Charger

- ▶ Disconnect the mains plug from the power supply.
- ▶ Remove the battery.

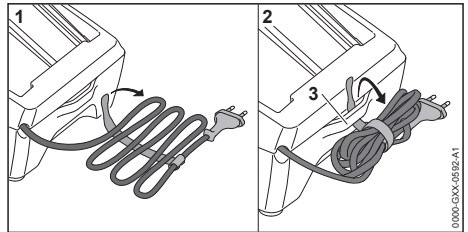

- ▶ Wind up the connecting cable and attach it to the charger.

- ▶ Observe the following points when storing the charger:
  - Charger is out of the reach of children.
  - The charger is clean and dry.
  - Charger is in an enclosed space.
  - Charger is stored separately, away from the battery.
  - The charger is not suspended from the connecting cable or the holder (3) for the connecting cable.
  - Charger is in a temperature range between + 5°C and + 40°C.

## 15 Cleaning

### 15.1 Cleaning the blower

- ▶ Switch off the blower and remove the battery.
- ▶ Clean blower with a damp cloth.
- ▶ Clean vents with a paintbrush.
- ▶ Clean the shield with a paintbrush or soft brush.
- ▶ Remove foreign objects from the battery compartment and clean the battery compartment with a damp cloth.
- ▶ Clean the electrical contacts in the battery compartment with a paintbrush or soft brush.

### 15.2 Cleaning the Battery

- ▶ Clean the battery with a damp cloth.

### 15.3 Cleaning the Charger

- ▶ Disconnect the mains plug from the power supply.
- ▶ Clean the charger with a damp cloth.
- ▶ Clean vents with a paintbrush.
- ▶ Clean the charger's electrical contacts with a paintbrush or a soft brush.

## 17 Troubleshooting

### 17.1 Troubleshooting

Condition	LEDs on Battery	Cause	Remedy
Blower does not start when switched on	1 LED flashes green.	Battery has low charge.	▶ Charge the battery.
	1 LED glows red.	Battery too hot or too cold.	▶ Remove the battery. ▶ Allow battery to cool down / warm up.
	3 LEDs flash red.	There is a malfunction in the blower.	▶ Remove the battery. ▶ Clean contacts in battery compartment. ▶ Fit the battery. ▶ Switch on the blower. ▶ If 3 LEDs continue to flash red: Do not use the blower and contact your STIHL servicing dealer for assistance.
	3 LEDs glow red.	Blower too hot.	▶ Remove the battery. ▶ Allow blower to cool down.

## 16 Maintenance and Repairs

### 16.1 Servicing and Repairing the Blower

The blower cannot be serviced or repaired by the user.

- ▶ If your blower has a malfunction or is damaged or requires servicing: Contact your STIHL servicing dealer.

### 16.2 Servicing and Repairing the Battery

The battery requires no servicing and cannot be repaired.

- ▶ If the battery has a malfunction or is damaged: Replace the battery.

### 16.3 Servicing and Repairing the Charger

The charger requires no servicing and cannot be repaired.

- ▶ If the charger has a malfunction or is damaged: Replace the charger.
- ▶ If the connecting cable has a malfunction or is damaged: Do not use the charger and have connecting cable replaced by a STIHL servicing dealer.

Condition	LEDs on Battery	Cause	Remedy
	4 LEDs flash red	There is a malfunction in the battery.	<ul style="list-style-type: none"> <li>▶ Remove battery and insert it again.</li> <li>▶ Switch on the blower.</li> <li>▶ If 4 LEDs continue to flash red: Do not use the battery and contact your STIHL dealer for assistance.</li> </ul>
		No electrical contact between blower and battery.	<ul style="list-style-type: none"> <li>▶ Remove the battery.</li> <li>▶ Clean contacts in battery compartment.</li> <li>▶ Fit the battery.</li> </ul>
		Blower or battery damp.	<ul style="list-style-type: none"> <li>▶ Allow blower or battery to dry.</li> </ul>
Blower cuts out during operation	3 LEDs glow red.	Blower too hot.	<ul style="list-style-type: none"> <li>▶ Remove the battery.</li> <li>▶ Allow blower to cool down.</li> </ul>
		There is a electrical malfunction.	<ul style="list-style-type: none"> <li>▶ Remove battery and insert it again.</li> <li>▶ Switch on the blower.</li> </ul>
Blower runtime is too short		Battery not fully charged.	<ul style="list-style-type: none"> <li>▶ Fully charge the battery.</li> </ul>
		Normal battery life has been exceeded.	<ul style="list-style-type: none"> <li>▶ Replace the battery.</li> </ul>
Charge process does not start when battery is inserted in the charger.	1 LED glows red.	Battery too hot or too cold.	<ul style="list-style-type: none"> <li>▶ Leave battery in the charger. Charge process starts automatically as soon as permissible temperature range is reached.</li> </ul>

## 17.2 Troubleshooting Charger

Condition	LED on Charger	Cause	Remedy
Battery not being charged.	LED flashes red.	No electrical contact between charger and battery.	<ul style="list-style-type: none"> <li>▶ Remove the battery.</li> <li>▶ Clean contacts on charger.</li> <li>▶ Fit the battery.</li> </ul>
		Malfunction in charger.	<ul style="list-style-type: none"> <li>▶ Do not use the charger and contact your STIHL servicing dealer.</li> </ul>

## 18 Specifications

### 18.1 STIHL BGA 57 Blower

- Approved battery: STIHL AK
- Air speed with nozzle mounted: 46 m/s
- Weight without battery: 2.3 kg

For battery life see [www.stihl.com/battery-life](http://www.stihl.com/battery-life).

### 18.2 STIHL AK Battery

- Battery technology: Lithium-ion
- Voltage: 36 V
- Capacity in Ah: see rating label
- Energy content in Wh: see rating label
- Weight in kg: see rating label
- Permissible temperature range for operation and storage: -10°C to +50°C

### 18.3 Charger STIHL AL 101

- Rated voltage: see rating plate
- Frequency: see rating plate
- Rated power: see rating plate

- Charging current: see rating plate
- Permissible temperature range for use and storage: + 5 °C to + 40 °C

The charging times are indicated at [www.stihl.com/charging-times](http://www.stihl.com/charging-times).

### 18.4 Extension Cords

If an extension cord is used, it must have a ground wire and the wire gage of its conductors must meet the following minimum requirements – depending on the line voltage and length of the extension cord:

**If rated voltage on the rating label is 220V to 240V:**

- Cord length up to 20 m: AWG 15 / 1.5 mm<sup>2</sup>
- Cord length 20 m up to 50 m: AWG 13 / 2.5 mm<sup>2</sup>



### If rated voltage on the rating label is 100 V to 127 V:

- Cord length up to 10 m: AWG 14 / 2.0 mm<sup>2</sup>
- Cord length 10 m up to 30 m: AWG 12 / 3.5 mm<sup>2</sup>

## 18.5 Noise and Vibration Data

K-value (uncertainty) for sound pressure levels is 2 dB(A). K-value (uncertainty) for sound power levels is 2 dB(A). K-value (uncertainty) for vibration levels is 2 m/s<sup>2</sup>.

STIHL recommends that you wear hearing protection.

- Sound pressure level  $L_{pA}$  measured according to EN 50636-2-100: 79 dB(A)
- Sound power level  $L_{WA}$  measured according to EN 50636-2-100: 90 dB(A)
- Vibration level  $a_{hV}$  measured according to EN 50636-2-100, control handle: < 2.5 m/s<sup>2</sup>.

The vibration values quoted above have been measured according to a standardized test procedure and may be used to compare electric power tools. Depending on the type of usage, the vibrations that actually occur may differ from the values quoted. The vibration values quoted may be used for an initial assessment of the user's exposure to vibrations. The actual exposure to vibrations has to be estimated. This process may also take into account times during which the electric power tool is switched off and times during which it is switched on but running off load.

For information on compliance with Vibration Directive 2002/44/EC visit [www.stihl.com/vib](http://www.stihl.com/vib).

## 18.6 REACH

REACH is an EC regulation and stands for the Registration, Evaluation, Authorisation and Restriction of Chemical substances.

For information on compliance with the REACH regulation see [www.stihl.com/reach](http://www.stihl.com/reach).

# 19 Spare Parts and Accessories

## 19.1 Spare parts and accessories

**STIHL**  These symbols indicate original STIHL spare parts and original STIHL accessories.

STIHL recommends the use of original STIHL spare parts and accessories.

Despite ongoing market observation, STIHL is unable to judge the reliability, safety and suitability of other manufacturers' spare parts and accessories; accordingly, STIHL cannot warrant for the use of those parts.

Original STIHL spare parts and original STIHL accessories are available from STIHL dealers.

## 20 Disposal

### 20.1 Disposal of Blower, Battery and Charger

Contact your STIHL servicing dealer for information on disposal.

- ▶ Dispose of the blower, battery, charger, accessories and packaging in accordance with local regulations and environmental requirements.

## 21 EC Declaration of Conformity

### 21.1 STIHL BGA 57 Blower

ANDREAS STIHL AG & Co. KG  
Badstraße 115  
D-71336 Waiblingen  
Germany

declares under our sole responsibility that

- Type: Cordless blower
- Manufacturer's brand: STIHL
- Model: BGA 57
- Serial number: 4523

conforms to the specifications of Directives 2011/65/EU, 2006/42/EC, 2014/30/EU and 2000/14/EC and has been developed and built in compliance with the versions of the following standards valid at the production date:  
EN 55014-1, EN 55014-2, EN 60335-1 and EN 50636-2-100.

The measured and guaranteed equivalent sound power level has been determined in accordance with Directive 2000/14/EC, Annex V.

- Measured sound power level: 90 dB(A)
- Guaranteed sound power level: 92 dB(A)

The technical documents are stored at ANDREAS STIHL AG & Co. KG Produktzulasung.

The year of construction, the country of manufacture and the machine number are shown on the blower.

Done at Waiblingen, 03.02.2020

ANDREAS STIHL AG & Co. KG



A handwritten signature in black ink, appearing to read "J. Hoffmann". The signature is written in a cursive style with a large initial "J".

pp  
Dr. Jürgen Hoffmann, Head of Product Data,  
Regulations and Licensing

## **21.2 STIHL AL 101 Charger Con- formity Notice**

This charger has been manufactured and put on the market in accordance with the following directives: 2014/35/EU, 2014/30/EU and 2011/65/EU.

The year of manufacture, country of manufacture and serial number are applied to the blower.

The complete EC Declaration of Conformity is available from ANDREAS STIHL AG & Co. KG, Badstrasse 115, 71336 Waiblingen, Germany.





[www.stihl.com](http://www.stihl.com)



0458-807-8321-B



0458-807-8321-B