

**STIHL**

**STIHL HSE 42, 52**

Instruction Manual





## Contents

|   |    |
|---|----|
| Guide to Using this Manual                | 2  |
| Safety Precautions and Working Techniques | 2  |
| Using the Unit                            | 6  |
| Connecting to Power Supply                | 7  |
| Switching On                              | 8  |
| Switching Off                             | 9  |
| Storing the Machine                       | 9  |
| Sharpening Instructions                   | 9  |
| Maintenance and Care                      | 10 |
| Minimize Wear and Avoid Damage            | 11 |
| Main Parts                                | 12 |
| Specifications                            | 13 |
| Maintenance and Repairs                   | 14 |
| Disposal                                  | 14 |
| EC Declaration of Conformity              | 14 |
| UKCA Declaration of Conformity            | 15 |
| General Power Tool Safety Warnings        | 16 |

# STIHL

HSE 42, HSE 52

Dear Customer,

Thank you for choosing a quality engineered STIHL product.

It has been built using modern production techniques and comprehensive quality assurance. Every effort has been made to ensure your satisfaction and trouble-free use of the product.

Please contact your dealer or our sales company if you have any queries concerning this product.

Your



Dr. Nikolas Stihl

## Guide to Using this Manual

### Pictograms

---

All the pictograms attached to the machine are shown and explained in this manual.

### Symbols in text

---



#### WARNING

Warning where there is a risk of an accident or personal injury or serious damage to property.



#### NOTICE

Caution where there is a risk of damaging the machine or its individual components.

### Engineering improvements

---

STIHL's philosophy is to continually improve all of its products. For this reason we may modify the design, engineering and appearance of our products periodically.

Therefore, some changes, modifications and improvements may not be covered in this manual.

## Safety Precautions and Working Techniques



Special safety precautions must be observed when working with this power tool because it has very sharp cutting blades and is powered by electricity.



It is important that you read and understand the User Manual before commissioning and keep it in a safe place for future reference. Non-compliance with the User Manual may cause serious or even fatal injury.

Observe the national safety regulations issued, e.g. by the employers' liability insurance association, social security institutions, occupational safety and health authorities or other organizations.

If you have not used this machine before: Have your dealer or other experienced user show you how to handle your machine safely, or attend a specialist course.

Minors must never work with the machine – except for young people over the age of 16 who are being trained under supervision.

Children, animals and onlookers must remain at a safe distance.

When the machine is not in use, shut it off so that it does not endanger others. Secure the machine against unauthorized access.

The user is responsible for accidents or risks involving third parties or their property.

Do not pass on or lend the machine to persons who are not familiar with this model and its handling – always include the User Manual.

Persons who are not able to operate the power tool safely due to limited physical, sensory or mental ability may work with it only under supervision or after being instructed appropriately by a responsible person.

The use of noise-emitting power tools may be restricted to certain times by national or local regulations.

To operate the power tool you must be rested, and in good physical condition and mental health.

If you have any condition that might be aggravated by strenuous work, check with your doctor before operating a machine.

Do not operate the power tool if you have consumed alcohol or taken medication which may impair responsiveness, or taken drugs.

Use your hedge trimmer only for cutting hedges, shrubs, scrub and similar materials.

Do not use the power tool for any other purpose due to the increased risk of accidents and damage to the power tool itself.

Always disconnect the machine from the mains power supply before starting any work on the machine – **risk of accident!**

Never jerk the power cord to disconnect it from the wall outlet. To unplug, grasp the plug, not the cord.

Unsuitable extension cords may be dangerous.

When using extension cords, ensure that the minimum conductor cross-sections are maintained (refer to the chapter entitled "Connecting the machine to the power supply").

The connector and coupling of the extension cord must be waterproof or routed in such a way that they cannot come into contact with water.

Only use cutting blades and accessories that are explicitly approved for this machine by STIHL or are technically identical. If you have any questions in this respect, consult a STIHL dealer. Use only high-quality parts and accessories. Otherwise there is a risk of accidents and damage to the unit.

STIHL recommends the use of genuine STIHL tools and accessories. They are specifically designed to match the product and meet your performance requirements.

Never attempt to modify your power tool in any way since this may increase the risk of personal injury. STIHL excludes all liability for personal injury and damage to property caused while using unauthorized attachments.

Do not use a high-pressure washer to clean the power tool. The solid jet of water may damage parts of the unit.

Do not spray the power tool with water.

## Clothing and equipment

Wear proper protective clothing and equipment.



Clothing must be sturdy but allow complete freedom of movement. Wear close-fitting clothes such as a boiler suit, not a loose jacket.

Do not wear clothing which could become trapped in wood, brush or moving parts of the machine. Do not wear a scarf, necktie or jewelry. Tie up and confine long hair above your shoulders.



Wear sturdy shoes with non-slip soles.



### WARNING



To reduce the risk of eye injuries, wear close-fitting safety glasses in accordance with European Standard EN 166. Make sure the protective glasses are a snug fit.

The use of hearing protection is recommended, e.g. ear defenders.



Wear sturdy protective gloves made of a resistant material (e. g. leather).

STIHL can supply a comprehensive range of personal protective equipment.

## Transporting the Machine

Always switch off the power tool, unplug it from the power supply and fit the blade scabbard – even when carrying the unit short distances.

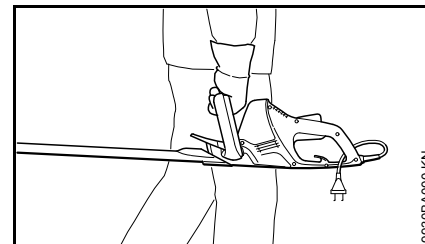

Carry the machine by the handle – with the cutting blades pointing to the rear.

Transporting by vehicle: Properly secure the power tool to prevent it tipping over and being damaged.

## Before starting work

Check that your machine is properly assembled and in good condition – refer to appropriate chapters in the instruction manual:

- Voltage and frequency of the machine (see rating plate) and the voltage and frequency of your power supply must be the same.
- Examine the connecting cord, power plug and extension cord for damage. Damaged cords, couplings and plugs or connecting cords that do not comply with the regulations must not be used
- Extension cord sockets must be splash-proof

- To reduce the risk of stumbling, position and clearly mark the connecting cable so that it cannot be damaged or endanger others.
- The trigger switch lockout, trigger switch and switch lever must move freely and return to the idle position when they are released.
- Cutting blades must be properly tightened and in safe operating condition (clean, sharp, not bent or warped), correctly mounted and thoroughly sprayed with STIHL resin solvent (lubricant).
- Check cutter guard (if fitted) for damage
- Never attempt to modify the controls or safety devices.
- Keep the handles dry and clean – free from oil and dirt – for safe control of the machine.

**To reduce the risk of accidents and personal injury, do not operate your power tool if it is not properly assembled and in good condition!**

To reduce the risk of electric shock:

- Always connect the engine analyzer to a properly installed wall outlet.
- Any extension cords used must comply with the specifications for the particular application
- Check that the insulation of the power cord, extension cord, plug and coupling is in good condition

## Holding and Guiding the Machine

Always hold the unit firmly with both hands on the handles. Wrap your fingers and thumbs around the handles.

### **Right-handed users**

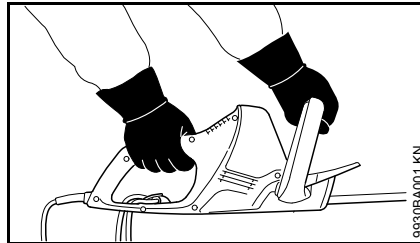

Right hand on the control handle and left hand on the loop handle.

### **Left-handed users**

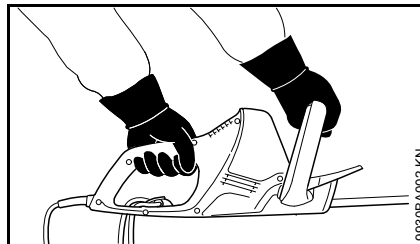

Left hand on the control handle and right hand on the loop handle.

Make sure you have a firm and secure footing and hold the unit so that the cutting blades are always away from your body.

## While working

In case of imminent danger or in an emergency, switch off the motor immediately – release the trigger switch and switch lever.

Ensure that there are no other people within the working area.

Watch the cutting blades at all times – do not cut areas of the hedge that you cannot see.

Be extremely careful when cutting tall hedges; check the other side of the hedge before starting work.



The drive motor is not waterproof. **To reduce the risk of a short circuit or electrocution**, never work with the power tool in the rain or in wet or very damp locations.

Do not leave the power tool outdoors in the rain.

Your power tool is equipped with a system designed to quickly stop the cutting blades – they come to an immediate standstill as soon as you release the trigger switch or the switch lever.

Check this function at regular, frequent intervals. Do not operate the machine if the cutting blades continue to run after switching off – **risk of injury!** Contact your servicing dealer.

Take special care in **slippery conditions** – damp, snow, ice, on slopes or uneven ground!

Clear away fallen branches, scrub and cuttings.

Watch out for obstacles such as tree stumps, roots – **risk of tripping or stumbling!**

#### When working at heights:

- Always use a lift bucket
- Never use the machine while standing on a ladder or in a tree
- never work on an unstable surface

Be particularly alert and cautious when wearing hearing protection because your ability to hear warnings (shouts, alarms, etc.) is restricted.

Take breaks when you start getting tired or feeling fatigue – **risk of accidents!**

Work calmly and carefully – in daylight conditions and only when visibility is good. Proceed with caution, do not put others in danger.

The gearbox becomes hot during operation. **To reduce the risk of burn injury**, do not touch the gearbox cover.

If your power tool is subjected to unusually high stress for which it was not designed (e.g. heavy impact or a fall), always check that it is in good condition before continuing work – see also "Before Starting". Make sure the safety devices are working properly. Never use a power tool that is no longer safe to operate. In case of doubt, contact a dealer.

Inspect the hedge and work area to avoid damaging the cutting blades:

- Remove stones, rocks, pieces of metal and other solid objects
- When working close to the ground, make sure that no sand, grit or stones get between the cutting blades
- Take particular care when cutting hedges next to or against wire fences

Do not touch electric power lines – never cut through electric power lines – **risk of electrocution!**



Do not touch the cutting blades while the engine is running. If the cutting blades become jammed by thick branches or other obstructions, switch off immediately and disconnect the plug from the power supply before attempting to free the blades.

If the hedge is very dusty or dirty, spray the cutting blades with STIHL resin solvent from time to time during cutting. This will significantly reduce blade friction, the aggressive effects of sap and the build-up of dirt particles.

The dust that occurs during operation may be harmful to health. Wear a dust mask in case of dust formation.



If the power cord is damaged, immediately disconnect the plug from the wall outlet to avoid the **risk of electric shock**.

Never jerk the power cord to disconnect it from the wall outlet. To unplug, grasp the plug, not the cord.

Avoid damage to the power supply cord. Do not drive over it, pinch or tug it.

Position the connecting and extension cords correctly:

- Do not chafe on edges, pointed or sharp objects
- don't trap or squeeze the cord in or under doors or windows
- If cords are twisted – unplug the power tool and straighten them out
- Always avoid contact with the cutting attachment
- Always completely unfurl the connecting cord from the cable reel to avoid risk of fire due to overheating.

Before leaving the power tool unattended: Switch it off and disconnect the plug from the power supply.

Check the cutting blades at regular, frequent intervals during operation or immediately if there is a noticeable change in cutting behavior:

- Switch off the power tool, wait for the cutting blades to come to a standstill, disconnect plug from power supply.
- Check the condition and tightness of connections, look out for fine cracks
- Ensure that the cutting blades are sharp

Always switch off the power tool and unplug it from the power supply before replacing the cutting blades. **Risk of injury** from the motor starting unintentionally!

Always clean plant residue, chips, leaves and excess lubricant off the motor – **risk of fire!**

### After finishing work

Always clean dust and dirt off the power tool – do not use any grease solvents for this purpose.

Spray the cutting blades with STIHL resin solvent. Run the motor briefly so that the solvent is evenly distributed.

### Vibrations

This power tool minimizes the vibrations transmitted to the operator's hands.

However, the operator should seek medical advice in the event of suspected circulatory problems in the hands (e.g. tingling sensation in the fingers).

### Maintenance and Repairs

Always switch off the machine and disconnect the plug from the power supply before carrying out any maintenance work to **reduce the risk of injury** from the motor starting unintentionally.

Service the machine regularly. Do not attempt any maintenance or repair work not described in the instruction manual. Have all other work performed by a servicing dealer.

STIHL recommends that you have servicing and repair work carried out exclusively by an authorized STIHL servicing dealer. STIHL dealers are regularly given the opportunity to attend training courses and are supplied with the necessary technical information.

Only use high-quality replacement parts in order to avoid the risk of accidents and damage to the machine. If you have any questions in this respect, consult a servicing dealer.

STIHL recommends the use of genuine STIHL replacement parts. They are specifically designed to match your machine model and meet your performance requirements.

Never attempt to modify your power tool in any way since this will increase the risk of personal injury.

Regularly check that the insulation of the power cord and plug is in good condition and shows no sign of ageing (brittleness).

Electrical components, e.g. power cord, may only be repaired or replaced by a qualified electrician.

Clean plastic components with a cloth. Do not use aggressive detergents. They may damage the plastic.

Do not spray the machine with water.

Check tightness of mounting screws on safety devices and the cutting attachment and retighten if necessary.

Clean cooling air inlets in motor housing as necessary.

Store the machine in a safe and dry place.

## Using the Unit

### Cutting Season

Observe country-specific or municipal rules and regulations for cutting hedges.

Do not use your power tool during other people's rest periods.

### Cutting Sequence

Use lopping shears or a chain saw to cut out thick branches first.

Cut both sides of the hedge first, then the top.

### Disposal

Do not throw cuttings in the garbage can – they can be composted!



## Working Technique

### Vertical Cut

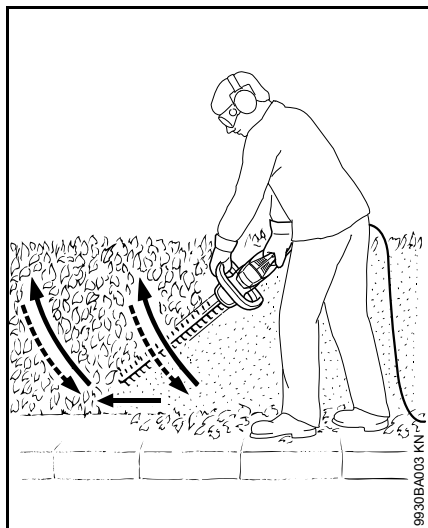

Swing the cutting blade from the bottom upwards in an arc – lower the nose of the blade, move along the hedge and then swing the blade up again in an arc.

Any working position above head height is tiring. To minimize the risk of accidents, work in such positions for short periods only.

### Horizontal Cut

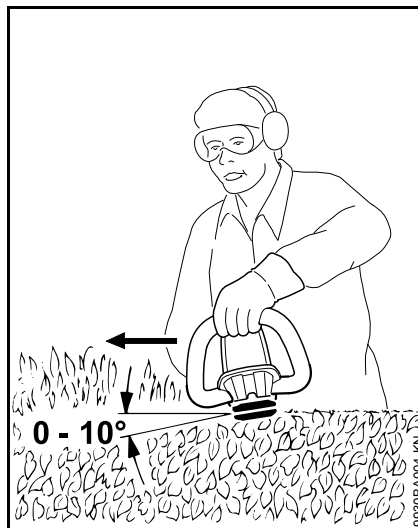

Hold the cutter bar at an angle of 0° to 10° as you swing the hedge trimmer horizontally.

Swing the cutting blade in an arc towards the outside of the hedge so that the cuttings are swept to the ground.

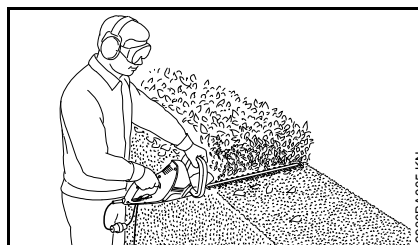

Repeat the procedure several times on wide hedges.

## Connecting to Power Supply

The voltage and frequency of the machine (see rating plate) must match the voltage and frequency of the power connection.

The minimum fuse protection of the power connection must comply with the specifications – see "Specifications".

The machine must be connected to the power supply via an earth-leakage circuit breaker to disconnect the power supply if the differential current to earth exceeds 30 mA.

The power connection must correspond to IEC 60364 and relevant national regulations.

### Extension cord

The design of the extension cord must at least fulfill the same features as the connecting cord on the machine. Observe the design marking (type designation) on the connecting cord.

The cores in the cord must have the following minimum cross-section depending on the mains voltage and cord length.

| Cord length           | Minimum cross-section        |
|-----------------------|------------------------------|
| <b>220 V – 240 V:</b> |                              |
| Up to 20 m            | 1.5 mm <sup>2</sup>          |
| 20 m to 50 m          | 2.5 mm <sup>2</sup>          |
| <b>100 V – 127 V:</b> |                              |
| Up to 10 m            | AWG 14 / 2.0 mm <sup>2</sup> |
| 10 m to 30 m          | AWG 12 / 3.5 mm <sup>2</sup> |

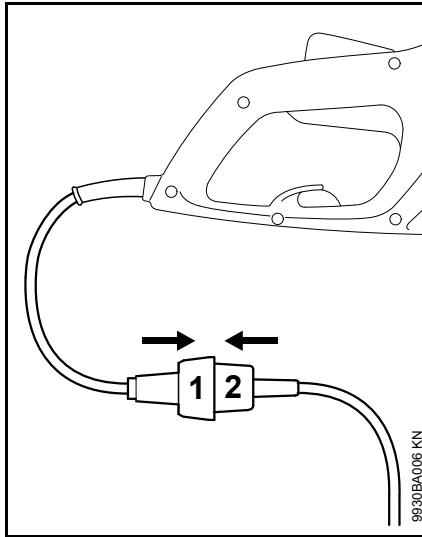

- Insert the plug (1) into the extension cord coupling (2).

### Strain relief (cord retainer)

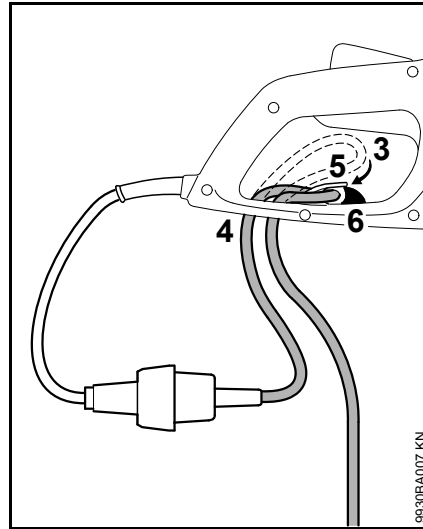

- Make a loop (3) in the extension cord.
- Pass the loop (3) through the opening (4).
- Slip the loop (3) over the hook (5) and pull it tight.
- Secure extension cord in position with lock (6) – the lock must snap into place.
- Connect the extension cord plug to a properly installed wall outlet.

### Switching On

- Make sure you have a secure and balanced footing.
- Stand upright – hold the power tool in a relaxed position.
- Make sure the cutting attachment is not touching the ground or any other objects.
- Hold the unit with both hands – one hand on the control handle – one hand on the loop handle.

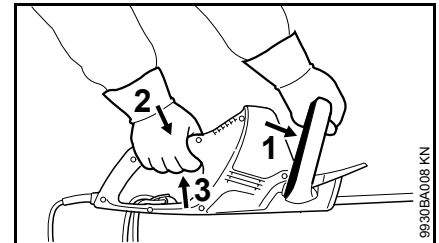

- Push the switch lever (1) against the loop handle and hold it there.
- Push down the trigger switch lockout (2), depress the trigger switch (3) and hold them in that position.

The machine is designed for two-hand operation, i.e. it will run only when the operator's hands are on the switch lever (1) and trigger switch (3).

## Switching Off

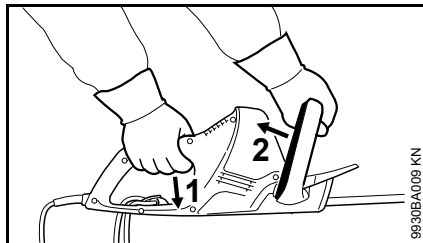

- Release the trigger switch (1) and the switch lever (2).
- During longer work breaks – disconnect the plug from the power supply.
- When the machine is not in use, shut it off so that it does not endanger others.
- Secure it against unauthorized use.

## Storing the Machine

For periods of 3 months or longer

- Clean the cutting blades, check condition and spray with STIHL resin solvent.
- Fit the blade scabbard.
- Thoroughly clean the machine, especially the cooling air inlets.
- Store the machine in a dry, locked location – the blade scabbard can be mounted to the wall for this purpose – out of the reach of children and other unauthorized persons.

## Sharpening Instructions

When cutting performance and behavior begin to deteriorate, i.e. blades frequently snag on branches: Resharpener the cutting blades.

It is best to have the cutting blades resharpened by a dealer on a workshop sharpener. STIHL recommends a STIHL servicing dealer.

It is also possible to use a flat crosscut sharpening file. Hold the sharpening file at the prescribed angle (see "Specifications").

- Only sharpen the cutting edge – do not file blunt projecting parts of the cutting blade or the cutting blade guard (see "Main Parts and Controls")
- Always file towards the cutting edge.
- The file only sharpens on the forward stroke – lift it off the blade on the backstroke.
- Use a whetstone to remove burr from cutting edge.
- Remove as little material as possible.
- After sharpening, clean away filing or grinding dust and then spray the cutting blades with STIHL resin solvent.



Do not operate your machine with dull or damaged cutting blades. This may cause overload and will give unsatisfactory cutting results.

## Maintenance and Care

| The following intervals apply for normal operating conditions. The specified intervals must be shortened accordingly when working for longer than normal or under difficult cutting conditions (extensive dust, etc.). |   | Before starting work | At the end of work and/or daily | Weekly | Monthly | Annually | If faulty | If damaged | As required |
|--|---|----------------------|---------------------------------|--------|---------|----------|-----------|------------|-------------|
|  |   |                      |                                 |        |         |          |           |            |             |
| Complete machine   | Visual inspection   | X                    |                                 |        |         |          |           |            |             |
|  | Clean   |                      | X                               |        |         |          |           |            |             |
| Two-hand control   | Check function – blades must quickly come to a standstill when the trigger switch or switch lever is released | X                    |                                 |        |         |          |           |            |             |
| Cool air intake port   | Visual inspection   |                      | X                               |        |         |          |           |            |             |
|  | Clean   |                      |                                 |        |         |          |           |            | X           |
| Cutting blades   | Visual inspection   | X                    |                                 |        |         |          |           |            |             |
|  | Clean <sup>2)</sup>   |                      | X                               |        |         |          |           |            |             |
|  | sharpen <sup>1)2)</sup>   |                      |                                 |        |         |          |           |            | X           |
|  | Have replaced by servicing dealer <sup>1)</sup>   |                      |                                 |        |         |          |           | X          |             |
| Gearbox and connecting rod   | inspection by a specialist dealer after every 50 hours of operation <sup>1)</sup>                             |                      |                                 |        |         |          |           |            |             |
|  | Have gearbox topped up with STIHL gear lubricant by servicing dealer <sup>1)</sup>                            |                      |                                 |        |         |          |           |            | X           |
| Carbon brushes   | inspection by a specialist dealer after every 100 hours of operation <sup>1)</sup>                            |                      |                                 |        |         |          |           |            |             |
|  | Have replaced by servicing dealer <sup>1)</sup>   |                      |                                 |        |         |          |           |            | X           |
| Accessible screws, nuts and bolts  | Tighten   |                      |                                 |        |         |          |           |            | X           |
| Safety information label   | replace   |                      |                                 |        |         |          |           | X          |             |

<sup>1)</sup> STIHL recommends STIHL dealers

<sup>2)</sup> Afterwards spray the blades with STIHL resin solvent

## Minimize Wear and Avoid Damage

Observing the instructions in this manual helps reduce the risk of unnecessary wear and damage to the power tool.

The power tool must be operated, maintained and stored with the due care and attention described in this instruction manual.

The user is responsible for all damage caused by non-observance of the safety precautions, operating and maintenance instructions in this manual. This includes in particular:

- Alterations or modifications to the product not approved by STIHL.
- Using tools or accessories which are neither approved or suitable for the product or are of a poor quality.
- Using the product for purposes for which it was not designed.
- Using the product for sports or competitive events.
- Consequential damage caused by continuing to use the product with defective components.

### Maintenance Work

All the operations described in the "Maintenance Chart" must be performed on a regular basis. If these maintenance operations cannot be performed by the owner, they should be performed by a servicing dealer.

STIHL recommends that you have servicing and repair work carried out exclusively by an authorized STIHL

servicing dealer. STIHL dealers are regularly given the opportunity to attend training courses and are supplied with the necessary technical information.

If these maintenance operations are not carried out as specified, the user assumes responsibility for any damage that may occur. Among other things, this includes:

- Damage to the motor due to neglect or deficient maintenance (e.g. not cleaning cooling air inlets).
- Damage due to incorrect electrical connection (voltage, inadequately rated connecting cords).
- Corrosion and other consequential damage resulting from improper storage.
- Damage to the product resulting from the use of poor quality replacement parts.

### Parts Subject to Wear and Tear

Some parts of the power tool are subject to normal wear and tear even during regular operation in accordance with instructions and, depending on the type and duration of use, have to be replaced in good time. Among other parts, this includes:

- Cutting blades

## Main Parts

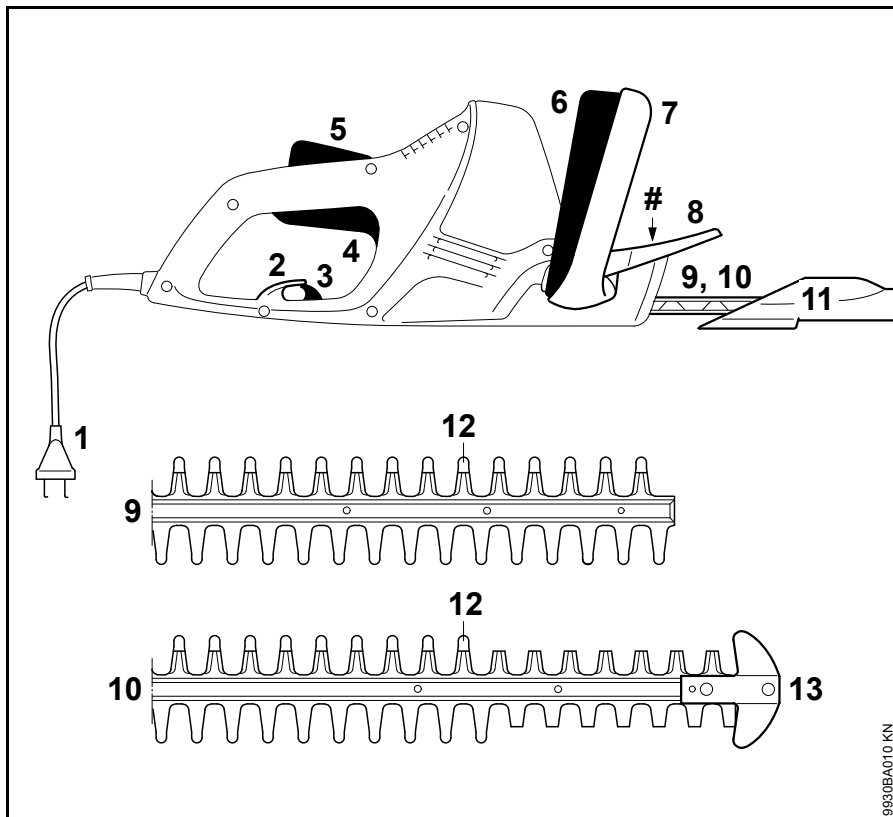

- 1 Power cord
- 2 Strain relief (cord retainer)
- 3 Lock for strain relief
- 4 Trigger
- 5 Trigger switch lockout
- 6 Switch lever
- 7 Loop handle
- 8 Hand guard
- 9 Cutting blades (HSE 42) – see "Specifications"
- 10 Cutting blades (HSE 52) – see "Specifications"
- 11 Blade scabbard
- 12 Blunt projection (integral cutter guard)
- 13 Tip guard (HSE 52 only)
- # Serial number

## Specifications

### Motor

#### HSE 42

|                    |   |
|--------------------|---|
| Voltage:           | 220 - 240 V   |
| Rated current:     | 1.9 A   |
| Frequency:         | 50 - 60 Hz  |
| Power consumption: | 420 W   |
| Fuse:              | min. 10 A   |
| Insulation:        | II,  |

#### HSE 52

|                    |   |
|--------------------|---|
| Voltage:           | 220 - 240 V   |
| Rated current:     | 2.1 A   |
| Frequency:         | 50 - 60 Hz  |
| Power consumption: | 460 W   |
| Fuse:              | min. 10 A   |
| Insulation:        | II,  |

### Cutting Blade

#### HSE 42

|                   |           |
|-------------------|-----------|
| Sharpening angle: | 36°       |
| Tooth spacing:    | 21 mm     |
| Stroke rate:      | 3,400/min |
| Cutting length:   | 450 mm    |

#### HSE 52

|                   |           |
|-------------------|-----------|
| Sharpening angle: | 32°       |
| Tooth spacing:    | 23 mm     |
| Stroke rate:      | 3,400/min |
| Cutting length:   | 500 mm    |

HSE 42, HSE 52

### Weight

|                        |        |
|------------------------|--------|
| HSE 42:                | 3.0 kg |
| HSE 42 <sup>1)</sup> : | 3.6 kg |
| HSE 52:                | 3.1 kg |
| HSE 52 <sup>1)</sup> : | 3.7 kg |

\* Versions with 10<sub>m</sub> appliance cord for UK

### Noise and Vibration Data

Noise and vibration data are determined on the basis of the rated maximum speed.

For further details on compliance with Vibration Directive 2002/44/EC see [www.stihl.com/vib/](http://www.stihl.com/vib/)

#### Sound pressure level $L_p$ to DIN EN 60745-2-15

|         |          |
|---------|----------|
| HSE 42: | 84 dB(A) |
| HSE 52: | 84 dB(A) |

#### Sound power level $L_w$ to DIN EN 60745-2-15

|         |          |
|---------|----------|
| HSE 42: | 95 dB(A) |
| HSE 52: | 95 dB(A) |

#### Vibration measurement $a_{HV}$ to DIN EN 60745-2-15

|         | Handle, left         | Handle, right        |
|---------|----------------------|----------------------|
| HSE 42: | 3.1 m/s <sup>2</sup> | 1.5 m/s <sup>2</sup> |
| HSE 52: | 3.1 m/s <sup>2</sup> | 1.5 m/s <sup>2</sup> |

The K-factor in accordance with Directive 2006/42/EC is 2.0 dB(A) for the sound pressure level and sound

power level; the K-factor in accordance with Directive 2006/42/EC is 2.0 m/s<sup>2</sup> for the vibration level.

The vibration values quoted above have been measured according to a standardized test procedure and may be used to compare electric power tools.

Depending on the type of usage, the vibrations that actually occur may differ from the values quoted.

The vibration values quoted may be used for an initial assessment of the user's exposure to vibrations.

The actual exposure to vibrations has to be evaluated. This process may also take into account times during which the electric power tool is switched off and times during which it is switched on but running without load.

### REACH

REACH is an EC regulation and stands for the Registration, Evaluation, Authorisation and Restriction of Chemical substances.

For information on compliance with the REACH regulation (EC) No. 1907/2006 see [www.stihl.com/reach](http://www.stihl.com/reach).

## Maintenance and Repairs

Users of this machine may only carry out the maintenance and service work described in this user manual. All other repairs must be carried out by a servicing dealer.

STIHL recommends that you have servicing and repair work carried out exclusively by an authorized STIHL servicing dealer. STIHL dealers are regularly given the opportunity to attend training courses and are supplied with the necessary technical information.

When repairing the machine, only use replacement parts which have been approved by STIHL for this power tool or are technically identical. Only use high-quality replacement parts in order to avoid the risk of accidents and damage to the machine.

STIHL recommends the use of original STIHL replacement parts.

Original STIHL parts can be identified by the STIHL part number, the **STIHL** logo and the STIHL parts symbol  (the symbol may appear alone on small parts).

## Disposal

Observe all country-specific waste disposal rules and regulations.

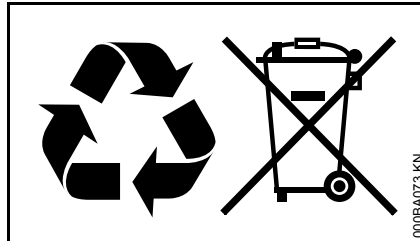

STIHL products must not be thrown in the garbage can. Take the product, accessories and packaging to an approved disposal site for environment-friendly recycling.

Contact your STIHL servicing dealer for the latest information on waste disposal.

## EC Declaration of Conformity

ANDREAS STIHL AG & Co. KG  
Badstr. 115  
D-71336 Waiblingen

Germany

declare under our sole responsibility that

|              |                        |
|--------------|------------------------|
| Designation: | Electric hedge trimmer |
| Make:        | STIHL                  |
| Series:      | HSE 42<br>HSE 52       |

|                               |      |
|-------------------------------|------|
| Serial identification number: | 4818 |
|-------------------------------|------|

conforms to the relevant provisions of Directives 2011/65/EU, 2006/42/EC, 2014/30/EU and 2000/14/EC and has been developed and manufactured in compliance with the following standards in the versions valid on the date of production:

EN 55014-1, EN 55014-2, EN 60745-1, EN 60745-2-15, EN 61000-3-2, EN 61000-3-3

The measured and the guaranteed sound power level have been determined in accordance with Directive 2000/14/EC, Annex V, and standard ISO 11094.

### Measured sound power level

|         |          |
|---------|----------|
| HSE 42: | 95 dB(A) |
| HSE 52: | 95 dB(A) |

### Guaranteed sound power level

|         |          |
|---------|----------|
| HSE 42: | 97 dB(A) |
| HSE 52: | 97 dB(A) |



Technical documents deposited at:

ANDREAS STIHL AG & Co. KG  
Produktzulassung

The year of construction, the country of manufacture and the machine number are shown on the machine.

Done at Waiblingen, 15.07.2021

ANDREAS STIHL AG & Co. KG

pp

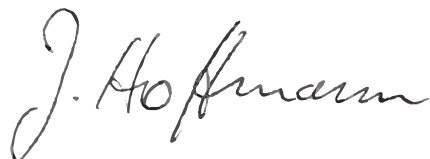

Dr. Jürgen Hoffmann

Director Product Certification &  
Regulatory Affairs



## UKCA Declaration of Conformity

ANDREAS STIHL AG & Co. KG  
Badstr. 115  
D-71336 Waiblingen

Germany

declare under our sole responsibility that

Designation: Electric hedge  
trimmer

Make: STIHL

Series: HSE 42

HSE 52

Serial identification  
number: 4818

conforms to the relevant provisions of UK regulations The Restriction of the Use of Certain Hazardous Substances in Electrical and Electronic Equipment Regulations 2012, Supply of Machinery (Safety) Regulations 2008, Electromagnetic Compatibility Regulations 2016 and Noise Emission in the Environment by Equipment for use Outdoors Regulations 2001 and has been manufactured in compliance with the following standards in the versions valid on the date of production:

EN 55014-1, EN 55014-2, EN 60745-1,  
EN 60745-2-15, EN 61000-3-2,  
EN 61000-3-3

The measured and the guaranteed sound power level have been determined in accordance with UK regulation Noise Emission in the Environment by Equipment for use Outdoors Regulations 2001, Anhang 8, using the ISO 11094 standard.

## Measured sound power level

HSE 42: 95 dB(A)

HSE 52: 95 dB(A)

## Guaranteed sound power level

HSE 42: 97 dB(A)

HSE 52: 97 dB(A)

Technical documents deposited at:

ANDREAS STIHL AG & Co. KG

The year of construction, the country of manufacture and the machine number are shown on the machine.

Done at Waiblingen, 15.07.2021

ANDREAS STIHL AG & Co. KG

pp



Dr. Jürgen Hoffmann

Director Product Certification &  
Regulatory Affairs



## General Power Tool Safety Warnings

This chapter reproduces the pre-formulated, general safety precautions specified in the EN 60745 European standard for hand-held motor-operated electric tools. **STIHL is required by law to print these standardized texts verbatim.**

**The safety precautions and warnings on avoiding an electric shock given under "2) Electric Precautions" do not apply to STIHL cordless electric power tools**



### WARNING

**Read all safety warnings and instructions.** Failure to follow the warnings and instructions may result in electric shock, fire and/or serious injury.

**Save all warnings and instructions for future reference.**

The term "power tool" in the warnings refers to your mains-operated (corded) power tool or battery-operated (cordless) power tool.

### 1) Work area safety

---

- a) **Keep work area clean and well lit.** Cluttered or dark areas invite accidents.
- b) **Do not operate power tools in explosive atmospheres, such as in the presence of flammable liquids, gases or dust.** Power tools create sparks which may ignite the dust or fumes.
- c) **Keep children and bystanders away while operating a power tool.** Distractions can cause you to lose control.

### 2) Electrical safety

---

- a) **Power tool plugs must match the outlet. Never modify the plug in any way. Do not use any adapter plugs with earthed (grounded) power tools.** Unmodified plugs and matching outlets will reduce risk of electric shock.
- b) **Avoid body contact with earthed or grounded surfaces, such as pipes, radiators, ranges and refrigerators.** There is an increased risk of electric shock if your body is earthed or grounded.
- c) **Do not expose power tools to rain or wet conditions.** Water entering a power tool will increase the risk of electric shock.

- d) **Do not abuse the cord. Never use the cord for carrying, pulling or unplugging the power tool. Keep cord away from heat, oil, sharp edges or moving parts.** Damaged or entangled cords increase the risk of electric shock.
- e) **When operating a power tool outdoors, use an extension cord suitable for outdoor use.** Use of a cord suitable for outdoor use reduces the risk of electric shock.
- f) **If operating a power tool in a damp location is unavoidable, use a residual current device (RCD) protected supply.** Use of an RCD reduces the risk of electric shock.

### 3) Personal safety

---

- a) **Stay alert, watch what you are doing and use common sense when operating a power tool. Do not use a power tool while you are tired or under the influence of drugs, alcohol or medication.** A moment of inattention while operating power tools may result in serious personal injury.
- b) **Use personal protective equipment. Always wear eye protection.** Protective equipment such as dust mask, non-skid safety shoes, hard hat, or hearing protection used for appropriate conditions will reduce personal injuries.

- c) **Prevent unintentional starting. Ensure the switch is in the off-position before connecting to power source and/or battery pack, picking up or carrying the tool.** Carrying power tools with your finger on the switch or energising power tools that have the switch on invites accidents.
- d) **Remove any adjusting key or wrench before turning the power tool on.** A wrench or a key left attached to a rotating part of the power tool may result in personal injury.
- e) **Do not overreach. Keep proper footing and balance at all times.** This enables better control of the power tool in unexpected situations.
- f) **Dress properly. Do not wear loose clothing or jewellery. Keep your hair, clothing and gloves away from moving parts.** Loose clothes, jewellery or long hair can be caught in moving parts.
- g) **If devices are provided for the connection of dust extraction and collection facilities, ensure these are connected and properly used.** Use of dust collection can reduce dust-related hazards.

#### 4) Power tool use and care

- a) **Do not force the power tool. Use the correct power tool for your application.** The correct power tool will do the job better and safer at the rate for which it was designed.
- b) **Do not use the power tool if the switch does not turn it on and off.** Any power tool that cannot be controlled with the switch is dangerous and must be repaired.
- c) **Disconnect the plug from the power source and/or the battery pack from the power tool before making any adjustments, changing accessories, or storing power tools.** Such preventive safety measures reduce the risk of starting the power tool accidentally.
- d) **Store idle power tools out of the reach of children and do not allow persons unfamiliar with the power tool or these instructions to operate the power tool.** Power tools are dangerous in the hands of untrained users.
- e) **Maintain power tools. Check for misalignment or binding of moving parts, breakage of parts and any other condition that may affect the power tool's operation. If damaged, have the power tool repaired before use.** Many accidents are caused by poorly maintained power tools.

- f) **Keep cutting tools sharp and clean.** Properly maintained cutting tools with sharp cutting edges are less likely to bind and are easier to control.
- g) **Use the power tool, accessories, tool bits etc. in accordance with these instructions, taking into account the working conditions and the work to be performed.** Use of the power tool for operations different from those intended could result in a hazardous situation.

#### 5) Service

- a) **Have your power tool serviced by a qualified repair person using only identical replacement parts.** This will ensure that the safety of the power tool is maintained.

#### Hedge Trimmer Safety Warnings

- **Keep all parts of the body away from the cutting blades. Do not remove cut material or hold material to be cut when blades are moving. Make sure the switch is off when clearing jammed material.** A moment of inattention while operating the hedge trimmer may result in serious personal injury.
- **Carry the hedge trimmer by the handle with the cutting blades stopped. When transporting or storing the hedge trimmer always fit the blade scabbard.** Proper handling of the hedge trimmer will reduce possible personal injury from the cutting blades.

- **Always hold your electric power tool by the insulated handles because the cutting blades may contact hidden electrical wires or your own power cord.** Any blade contact with a live wire may energize metallic parts of the power tool and result in an electric shock.
- **Keep the power cord away from cutting area.** During operation the power cord may be hidden in shrubs and can be accidentally severed by the blade.







0458-762-0121-B

englisch



[www.stihl.com](http://www.stihl.com)



0458-762-0121-B