

STIHL

STIHL FS 260, 360

Instruction Manual



Contents

Guide to Using this Manual	2	Specifications	46
Safety Precautions and Working Techniques	2	Maintenance and Repairs	48
Approved Combinations of Cutting Attachment, Deflector, Limit Stop and Harness	13	Disposal	48
Mounting the Bike Handle	15	EC Declaration of Conformity	48
Adjusting the Throttle Cable	18		
Mounting the Deflector	18		
Mounting the Cutting Attachment	19		
Fuel	24		
Fueling	25		
Fitting the Full Harness	26		
Balancing the Machine	28		
Starting / Stopping the Engine	29		
Transporting the Unit	31		
Operating Instructions	33		
Air filter	33		
Adjusting the Carburetor	34		
Winter Operation	35		
Spark Plug	36		
Engine Running Behavior	37		
Storing the Machine	38		
Sharpening Metal Cutting Blades	38		
Maintaining the Mowing Head	39		
Inspection and Maintenance by User	40		
Inspections and Maintenance by Dealer	41		
Maintenance and Care	42		
Minimize Wear and Avoid Damage	44		
Main Parts	45		

Dear Customer,

Thank you for choosing a quality engineered STIHL product.

It has been built using modern production techniques and comprehensive quality assurance. Every effort has been made to ensure your satisfaction and trouble-free use of the product.

Please contact your dealer or our sales company if you have any queries concerning this product.

Your



Dr. Nikolas Stihl

STIHL

FS 260, FS 260 C, FS 360 C

This instruction manual is protected by copyright. All rights reserved, especially the rights to reproduce, translate and process with electronic systems.

Guide to Using this Manual

Pictograms

The meanings of the pictograms attached to the machine are explained in this manual.

Depending on the model concerned, the following pictograms may be attached to your machine.



Fuel tank; fuel mixture of gasoline and engine oil

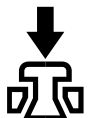

Operate decompression valve



Manual fuel pump

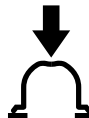

Operate manual fuel pump

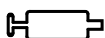

Tube of grease



Intake air: Summer operation



Intake air: Winter operation



Handle heating

Symbols in text



WARNING

Warning where there is a risk of an accident or personal injury or serious damage to property.



NOTICE

Caution where there is a risk of damaging the machine or its individual components.

Engineering improvements

STIHL's philosophy is to continually improve all of its products. For this reason we may modify the design, engineering and appearance of our products periodically.

Therefore, some changes, modifications and improvements may not be covered in this manual.

Safety Precautions and Working Techniques



Special safety precautions must be observed when working with a power tool.



It is important that you read the instruction manual before first use and keep it in a safe place for future reference. Non-observance of the instruction manual may result in serious or even fatal injury.

Observe all applicable local safety regulations, standards and ordinances.

If you have not used this type of power tool before: Have your dealer or other experienced user show you how it is operated or attend a special course in its operation.

Minors should never be allowed to use a power tool.

Keep bystanders, especially children, and animals away from the work area.

When the power tool is not in use, shut it off so that it does not endanger others. Secure it against unauthorized use.

The user is responsible for avoiding injury to third parties or damage to their property.

Do not lend or rent your power tool without the instruction manual. Be sure that anyone using it understands the information contained in this manual.

The use of noise emitting power tools may be restricted to certain times by national or local regulations.

To operate the power tool you must be rested, in good physical condition and mental health.

If you have any condition that might be aggravated by strenuous work, check with your doctor before operating a power tool.

Persons with pacemakers only: The ignition system of your power tool produces an electromagnetic field of a very low intensity. This field may interfere with some pacemakers. STIHL recommends that persons with pacemakers consult their physician and the pacemaker manufacturer to reduce any health risk.

Do not operate the power tool if you are under the influence of any substance (drugs, alcohol) which might impair vision, dexterity or judgment.

Depending on the cutting attachment fitted, use your power tool only for cutting grass, wild growth, shrubs, scrub, bushes, small diameter trees and similar materials.

Do not use your power tool for any other purpose because of the **increased risk of accidents**.

Only use cutting attachments and accessories that are explicitly approved for this power tool model by STIHL or are technically identical. If you have any questions in this respect, consult a servicing dealer. Use only high quality tools and accessories in order to avoid the risk of accidents and damage to the machine.

STIHL recommends the use of genuine STIHL tools and accessories. They are specifically designed to match the product and meet your performance requirements.

Never attempt to modify your machine in any way since this may increase the risk of personal injury. STIHL excludes all liability for personal injury and damage to property caused while using unauthorized attachments.

Do not use a pressure washer to clean your power tool. The solid jet of water may damage parts of the power tool.

The deflector on this power tool cannot protect the operator from all objects thrown by the cutting attachment (stones, glass, wire, etc.). Such objects may ricochet and then hit the operator.

Clothing and Equipment

Wear proper protective clothing and equipment.



Clothing must be sturdy but allow complete freedom of movement. Wear snug-fitting clothing, an overall and jacket combination, do not wear a work coat.

Avoid clothing that could get caught on branches or brush or moving parts of the machine. Do not wear a scarf, necktie or jewelry. Tie up long hair so that it is above shoulder level.



Wear steel-toed safety boots with non-slip soles.

Sturdy shoes with non-slip soles may be worn as an alternative only when using mowing heads.



WARNING



To reduce the risk of eye injuries, wear close-fitting safety glasses in accordance with European Standard EN 166. Make sure the safety glasses are a comfortable and snug fit.

Wear a face shield and make sure it is a good fit. A face shield alone does not provide adequate eye protection.

Wear hearing protection, e.g. earplugs or ear muffs.

Wear a safety hard hat for thinning operations, when working in high scrub and where there is a danger of head injuries from falling objects.



Wear heavy-duty work gloves made of durable material (e.g. leather).

STIHL offers a comprehensive range of personal protective clothing and equipment.

Transporting the Power Tool

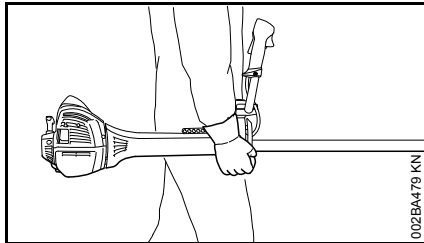

Always stop the engine.

Carry the unit hanging from the shoulder strap or properly balanced by the drive tube.

To reduce the risk of cut injuries, fit transport guard on the cutting attachment, even when carrying the tool for short distances – see also "Transporting the Unit".



To reduce the risk of serious burn injuries, avoid touching hot parts of the machine, including the gearbox.

Transporting by vehicle: Properly secure your power tool to prevent turnover, fuel spillage and damage.

Fueling



Gasoline is an extremely flammable fuel. Keep clear of naked flames. Do not spill any fuel – do not smoke.

Always shut off the engine before refueling.

Do not fuel a hot engine – fuel may spill and **cause a fire**.

Open the fuel cap carefully to allow any pressure build-up in the tank to release slowly and avoid fuel spillage.

Fuel your power tool only in well-ventilated areas. If you spill fuel, wipe the machine immediately – if fuel gets on your clothing, change immediately.



After fueling, tighten down the fuel tank cap as securely as possible.

This reduces the risk of unit vibrations causing the fuel cap to loosen or come off and spill quantities of fuel.

To reduce the risk of serious or fatal burn injuries, check for fuel leakage. If fuel leak is found, do not start the engine.

Before Starting

Check that your power tool is properly assembled and in good condition – refer to appropriate chapters in the instruction manual.

- Check the fuel system for leaks, paying special attention to visible parts such as the tank cap, hose connections and the manual fuel pump (on machines so equipped).

there are any leaks or damage, do not start the engine – **risk of fire**. Have your machine repaired by a servicing dealer before using it again.

- Use only an approved combination of cutting attachment, deflector, handle and harness. All parts must be assembled properly and securely.
- The stop switch must move freely.
- Check smooth action of choke knob, throttle trigger lockout and throttle trigger – the throttle trigger must return automatically to the idle position. The choke knob must spring back from the **I** and **II** positions to the run position **I** when the throttle trigger lockout and throttle trigger are squeezed.
- Check that the spark plug boot is secure – a loose boot may cause arcing that could ignite combustible fumes **and cause a fire**.
- Check cutting tool or attachment for correct and secure assembly and good condition.
- Check protective devices (e.g. deflector for cutting attachment, rider plate) for damage or wear. Always replace damaged parts. Do not operate your machine with a damaged deflector or worn rider plate (lettering and arrows no longer legible).
- Never attempt to modify the controls or safety devices in any way.

- Keep the handles dry and clean – free from oil and dirt – for safe control of the power tool.
- Adjust the harness and handle(s) to suit your height and reach. See chapters on "Fitting the Harness" and "Balancing the Machine".

To reduce the risk of accidents, operate your power tool only if it is in a safe condition.

If you use a shoulder strap or full harness: Practice removing and putting down the machine as you would in an emergency. To avoid damage, do not throw the machine to the ground when practicing.

Starting the Engine

Start the engine at least 3 meters from the fueling spot, outdoors only.

Place the unit on firm ground in an open area. Make sure you have good balance and secure footing. Hold the unit securely. The cutting attachment must be clear of the ground and all other obstructions because it may begin to run when the engine starts.

Your power tool is a one-person unit. **To reduce the risk of injury** from thrown objects, do not allow other persons within a radius of 15 meters of your own position – even when starting.



To reduce the risk of injury, avoid contact with the cutting attachment.



Do not drop start the power tool – start the engine as described in the instruction manual. Note that the cutting attachment continues to run for a short period after you let go of the throttle trigger – **flywheel effect**.

Check idle speed setting: The cutting attachment must not rotate when the engine is idling with the throttle trigger released.

To reduce the risk of fire, keep hot exhaust gases and hot muffler away from easily combustible materials (e.g. wood chips, bark, dry grass, fuel).

Holding and Controlling the Power Tool

Always hold the power tool firmly with both hands on the handles.

Make sure you always have good balance and secure footing.

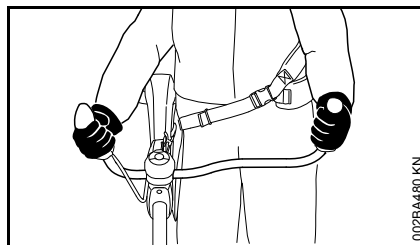

Right handle on control handle, left hand on left handle.

During Operation

Make sure you always have good balance and secure footing.

In the event of imminent danger or in an emergency, press the stop switch to shut off the engine.

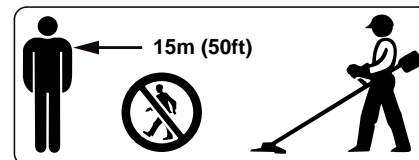

The cutting attachment may catch and fling objects a great distance and cause injury - therefore, do not allow any other persons within a radius of 15 meters of your own position. **To reduce the risk of damage to property**, also maintain this distance from other objects (vehicles, windows). Even maintaining a distance of 15 meters or more cannot exclude the potential danger.

The correct engine idle speed is important to ensure that the cutting attachment stops rotating when you let go of the throttle trigger.

Check and correct the idle speed setting regularly. If the cutting attachment continues to rotate when the engine is idling, have the machine checked by your servicing dealer. STIHL recommends an authorized STIHL servicing dealer.

Take special care in slippery conditions (ice, wet ground, snow), on slopes or uneven ground.

Watch out for obstacles: Roots and tree stumps which **could cause you to trip or stumble**.

Always stand on the ground while working, never on a ladder, work platform or any other insecure support.

Be particularly alert and cautious when wearing hearing protection because your ability to hear warnings (shouts, alarms, etc.) is restricted.

To reduce the risk of accidents, take a break in good time to avoid tiredness or exhaustion.

Work calmly and carefully – in daylight conditions and only when visibility is good. Stay alert so as not to endanger others.



Your power tool produces toxic exhaust fumes as soon as the engine is running. These fumes may be colorless and odorless and contain unburned hydrocarbons and benzol. Never run the engine indoors or in poorly ventilated locations, even if your model is equipped with a catalytic converter.

To reduce the risk of serious or fatal injury from breathing toxic fumes, ensure proper ventilation when working in trenches, hollows or other confined locations.

To reduce the risk of accidents, stop work immediately in the event of nausea, headache, visual disturbances (e.g. reduced field of vision), problems with hearing, dizziness, deterioration in ability to concentrate. Apart from other

possibilities, these symptoms may be caused by an excessively high concentration of exhaust gases in the work area.

Operate your power tool so that it produces a minimum of noise and emissions – do not run the engine unnecessarily, accelerate the engine only when working.

To reduce the risk of fire, do not smoke while operating or standing near your power tool. Note that combustible fuel vapor may escape from the fuel system.

The dusts, vapor and smoke produced during operation may be dangerous to health. If the work area is very dusty or smoky, wear a respirator.

If your power tool is subjected to unusually high loads for which it was not designed (e.g. heavy impact or a fall), always check that it is in good condition before continuing work – see also "Before Starting".

Check the fuel system in particular for leaks and make sure the safety devices are working properly. Do not continue operating your power tool if it is damaged. In case of doubt, consult your servicing dealer.

Do not operate your power tool with the choke knob in the warm start position  – the engine speed cannot be controlled in this position.



To reduce the risk of injury from thrown objects, never operate the unit without the proper deflector for the type of cutting attachment being used.



Inspect the work area: Stones, pieces of metal or other solid objects may be thrown more than 15 meters and **cause personal injury** or damage the cutting attachment and property (e.g. parked vehicles, windows).

Special care must be taken when working in difficult, over-grown terrain.

When cutting high scrub, under bushes and hedges: Keep cutting attachment at a minimum height of 15 cm to avoid harming small animals.

Always shut off the engine before leaving the machine unattended.

Check the cutting attachment at regular short intervals during operation or immediately if there is a noticeable change in cutting behavior:

- Turn off the engine. Hold the unit firmly and wait for the cutting attachment to come to a standstill.
- Check condition and tightness, look for cracks.
- Check sharpness.
- Replace damaged or dull cutting attachments immediately, even if they have only superficial cracks.

Clean grass and plant residue off the cutting attachment mounting at regular intervals – remove any build up of material from the cutting attachment and deflector.

To reduce the risk of injury, shut off the engine before changing the cutting attachment.



The gearbox gets hot during operation. **To reduce the risk of burn injury**, do not touch the gearbox housing.

When using mowing heads

Use only the deflector with properly mounted line limiting blade to ensure the mowing lines are automatically trimmed to the approved length.

To reduce the risk of injury, always turn off the engine before adjusting the nylon line of manually adjustable mowing heads.

Using the unit with over-long nylon cutting lines reduces the engine's operating speed. The clutch then slips continuously and this causes overheating and damage to important components (e.g. clutch, polymer housing components) – **and this can increase the risk of injury** from the cutting attachment rotating while the engine is idling.

Using metal cutting attachments

STIHL recommends the use of original STIHL metal cutting attachments. They are specifically designed to match your model and meet your performance requirements.

Metal cutting attachments rotate at very high speed. The forces that occur act on the machine, the attachment and the material being cut.

Metal cutting attachments must be sharpened regularly as specified.

Unevenly sharpened metal cutting attachments cause out-of-balance which can impose extremely high loads on the machine and increase the **risk of breakage**.

Dull or improperly sharpened cutting edges can put a higher load on the cutting attachment and increase the **risk of injury** from cracked or broken parts.

Inspect metal cutting attachments for cracks or warping after every contact with hard objects (e.g. stones, rocks, pieces of metal). **To reduce the risk of injury**, remove burrs and other visible build-ups of material (use a file) because they may become detached and be thrown at high speed during operation.

If a rotating metal cutting attachment makes contact with a rock or other solid object there is a risk of sparking which may cause easily combustible material to catch fire under certain circumstances. Dry plants and scrub are also easily combustible, especially in hot and dry weather conditions. If there is a risk of fire, do not use metal cutting attachments near combustible

materials, dry plants or scrub. Always contact your local forest authority for information on a possible fire risk.

Do not continue using or attempt to repair damaged or cracked cutting attachments by welding, straightening or modifying the shape (out of balance).

This may cause parts of the cutting attachment to come off and hit the operator or bystanders at high speed and **result in serious or fatal injuries**.

To reduce the above-mentioned risks when using a metal cutting attachment, never use a metal cutting attachment with a diameter larger than specified. It must not be too heavy. It must be manufactured from materials of adequate quality and its geometry must be correct (shape, thickness).

To reduce the risk of injury, a metal cutting attachment not manufactured by STIHL must not be heavier, thicker, have a different shape or a diameter larger than the largest metal cutting attachment approved by STIHL for this power tool model.

Vibrations

Prolonged use of the power tool may result in vibration-induced circulation problems in the hands (whitefinger disease).

No general recommendation can be given for the length of usage because it depends on several factors.

The period of usage is prolonged by:

- Hand protection (wearing warm gloves)
- Work breaks

The period of usage is shortened by:

- Any personal tendency to suffer from poor circulation (symptoms: frequently cold fingers, tingling sensations).
- Low outside temperatures.
- The force with which the handles are held (a tight grip restricts circulation).

Continual and regular users should monitor closely the condition of their hands and fingers. If any of the above symptoms appear (e.g. tingling sensation in fingers), seek medical advice.

Maintenance and Repairs

Service the machine regularly. Do not attempt any maintenance or repair work not described in the instruction manual. Have all other work performed by a servicing dealer.

STIHL recommends that you have servicing and repair work carried out exclusively by an authorized STIHL servicing dealer. STIHL dealers are regularly given the opportunity to attend training courses and are supplied with the necessary technical information.

Only use high-quality replacement parts in order to avoid the risk of accidents and damage to the machine. If you have any questions in this respect, consult a servicing dealer.

STIHL recommends the use of original STIHL replacement parts. They are specifically designed to match your model and meet your performance requirements.

To reduce the risk of injury from unintentional engine startup, **always shut off the engine and disconnect the spark plug boot** before performing any repairs, maintenance or cleaning work. – Exception: Carburetor and idle speed adjustments.

Do not turn the engine over on the starter with the spark plug boot or spark plug removed since there is otherwise a **risk of fire** from uncontained sparking.

To reduce the **risk of fire**, do not service or store your machine near open flames.

Check the fuel filler cap for leaks at regular intervals.

Use only a spark plug of the type approved by STIHL and make sure it is in good condition – see "Specifications".

Inspect the ignition lead (insulation in good condition, secure connection).

Check the condition of the muffler.

To reduce the **risk of fire and damage to hearing**, do not operate your machine if the muffler is damaged or missing. –

Do not touch a hot muffler since **burn injury** will result.

Vibration behavior is influenced by the condition of the AV elements – check the AV elements at regular intervals.

Symbols on Deflectors

An **arrow** on the deflector shows the correct direction of rotation of the cutting attachments.

Some of the following symbols are applied to the outside of the deflector to indicate the approved combination of cutting attachment and deflector.



Deflector may be used with mowing heads.



Deflector may be used with grass cutting blades.



Deflector may be used with brush knives.



Deflector may be used with shredder blades.



Deflector must not be used with mowing heads.



Deflector must not be used with grass cutting blades.



Deflector must not be used with brush knives.



Deflector must not be used with shredder blades.



Deflector must not be used with circular saw blades.

Harness

The harness is included with the machine or available as a special accessory.

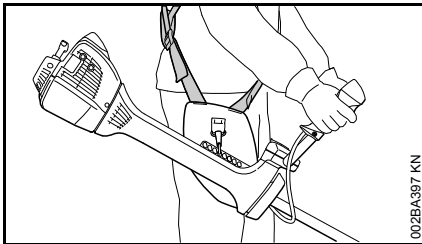

- Use the harness.
- With the engine running, attach the machine to the harness.

All cutting attachments must be used in combination with a full harness with a quick-release system.

Mowing Head with Nylon Line

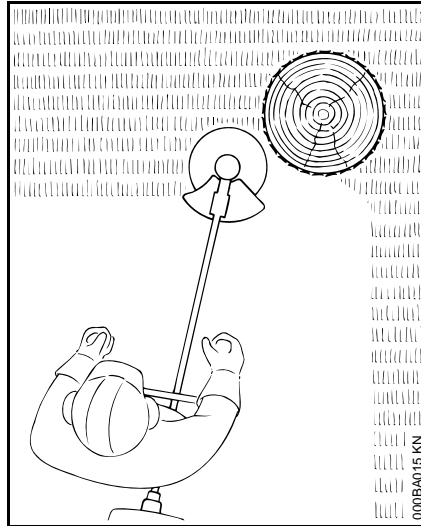

Nylon line achieves a soft cut for edging and trimming around trees, fence posts, etc. – less risk of damaging tree bark.

The mowing head comes with an instruction leaflet. Refill the mowing head with nylon line as described in the instruction leaflet.



To reduce the risk of serious injury, never use wire or metal-reinforced line in place of the nylon line.

STIHL DuroCut

Check the wear limit marks!

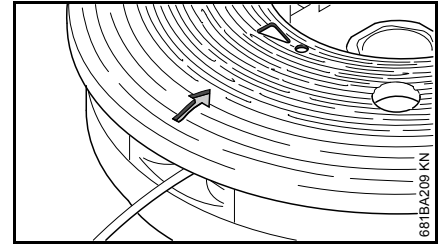

If one of the wear limit marks imbedded in the baseplate of the DuroCut (**exclamation marks**) becomes visible, do not continue using the mowing head since it may otherwise be damaged.

Replace the worn baseplate.

The mowing head comes with instruction leaflets. Equip the mowing head only with nylon line as described in the instruction leaflets.



Never use wire in place of the nylon mowing line – risk of injury.

STIHL Polycut Mowing Head with Polymer Blades

For mowing unobstructed edges of meadows (without posts, fences, trees or similar obstacles).

Check the wear limit marks!

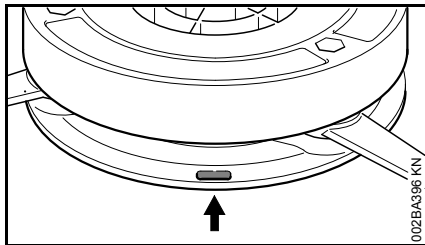

If one of the wear limit marks on the PolyCut mowing head is worn through (arrow): Do not continue using the mowing head. Install a new one. There is otherwise a **risk of injury** from thrown parts of the head.

It is important to follow the maintenance instructions for the PolyCut mowing head.

The PolyCut can also be equipped with mowing line in place of the polymer blades.

The mowing head comes with instruction leaflets. Equip the mowing head with polymers blades or nylon line as described in the instruction leaflets.

! WARNING

Never use wire in place of the nylon mowing line – **risk of injury**.

Risk of Kickout (Blade Thrust) with Metal Cutting Attachments

! WARNING



When using metal cutting attachments there is a risk of kickout when the rotating blade comes into contact with a solid object such as a tree trunk, branch, tree stump, rock or similar. The machine is thrown to the right or to the rear – opposite to the attachment's direction of rotation.

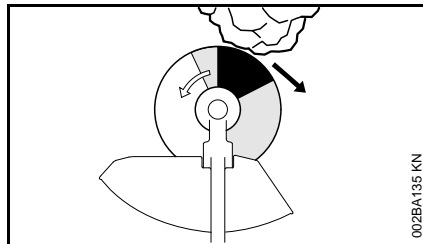

The **risk of kickout is greatest** when the **black area** of the rotating cutting attachment comes into contact with a solid object.

Grass Cutting Blade

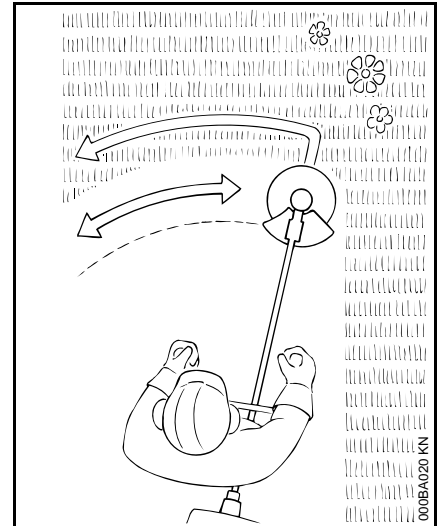

Use for grass and weeds only – sweep the brushcutter in an arc like a scythe.

! WARNING

Improper use may damage the grass cutting blade – **risk of injury** from thrown parts.

Resharpener the grass cutting blade according to instructions when it has dulled noticeably.

Brush Knife

For cutting matted grass, wild growth and scrub and thinning young stands with a stem diameter of no more than 2 cm – do not cut thicker stems – **risk of accidents**.

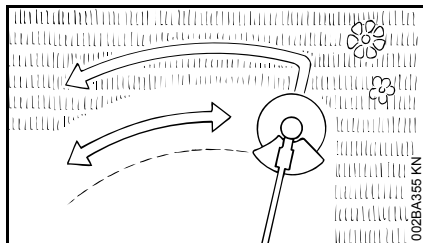

Use the brushcutter like a scythe (sweep it to the right and left) at ground level when cutting grass and thinning young stands.

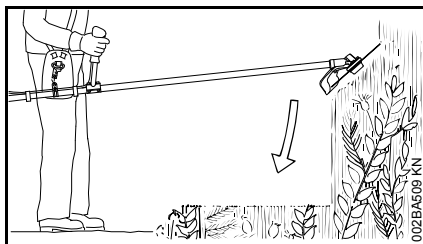

To cut wild growth and scrub, lower the brush knife down onto the growth to achieve a shredding effect – always keep the cutting attachment below hip level during this process.

Exercise extreme caution when using this method of cutting. The higher the cutting attachment is off the ground, the greater the risk of injury from cuttings being thrown sideways.

Warning! Improper use of a brush knife may cause it to crack, chip or shatter – **risk of injury** from thrown parts.

To reduce the risk of injury it is essential to take the following precautions:

- Avoid contact with stones, rocks, pieces of metal and other solid foreign objects.
- Never cut wood or shrubs with a stem diameter of more than 2 cm – use a circular saw blade for such work.
- Inspect the brush knife at regular short intervals for signs of damage. Do not continue working with a damaged brush knife.
- Resharpener the brush knife regularly and whenever it has dulled noticeably, and have it balanced if necessary (STIHL recommends a STIHL servicing dealer).

Shredder Blade

Suitable for thinning and shredding tough, matted grass and scrub.

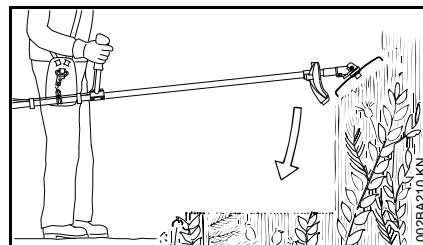

To cut wild growth and scrub, lower the shredder blade down onto the growth to achieve a shredding effect – always keep the cutting attachment below hip level during this process.

Exercise extreme caution when using this method of cutting. The higher the cutting attachment is off the ground, the greater the risk of injury from cuttings being thrown sideways.

Warning! Improper use may damage the shredder blade – **risk of injury** from thrown parts.

To reduce the risk of injury it is essential to take the following precautions:

- Avoid contact with stones, rocks, pieces of metal and other solid foreign objects.
- Never cut wood or shrubs with a stem diameter of more than 2 cm – use a circular saw blade for such work.
- Inspect the shredder blade at regular short intervals for signs of damage. Do not continue working with a damaged shredder blade.
- Resharpener the shredder blade regularly and whenever it has dulled noticeably, and have it balanced if necessary (STIHL recommends a STIHL servicing dealer).

Circular Saw Blade

Suitable for cutting shrubs and trees with a maximum stem diameter of 7 cm.

Before starting the cut, accelerate the engine up to full throttle. Perform cut with uniform pressure.

Use circular saw blades only with a matching limit stop of the correct diameter.

! WARNING

To reduce the risk of blade damage, avoid contact with stones and the ground. Resharpener the blade properly in good time – dull teeth may result in the blade cracking and shattering and causing serious injury.

When felling, maintain a distance of at least two tree lengths from the next felling site.

Risk of kickout

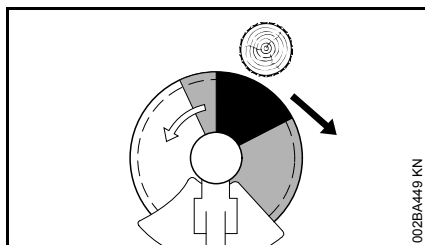



The risk of kickout is highest in the black area of the blade: Do not use this area of the circular saw blade for cutting.

There is also a risk of kickout when using the lighter shaded areas of the blade: These areas of the blade should only be used by experienced operators with specialized training.

STIHL recommends that you use the non-shaded area of the circular saw blade. Always start the cut with this area of the blade.

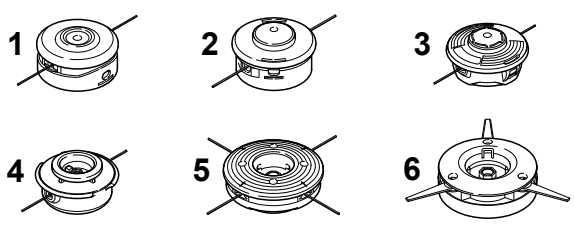
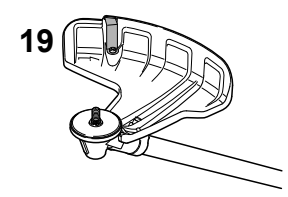
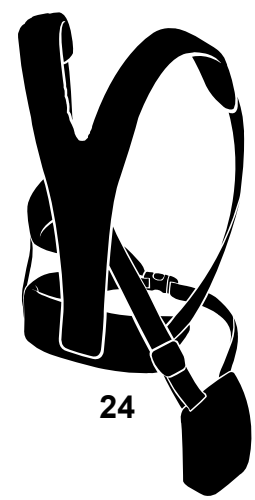
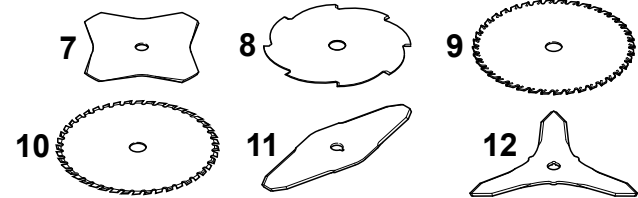
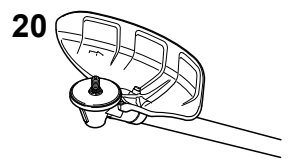
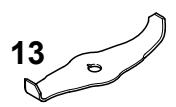
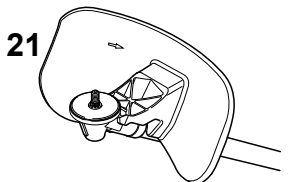
Approved Combinations of Cutting Attachment, Deflector, Limit Stop and Harness

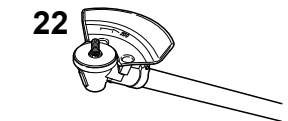
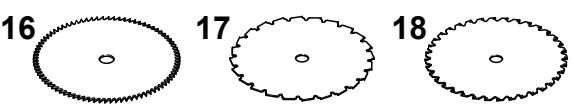
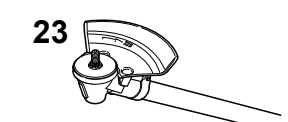
Cutting Attachment	Deflector, Limit Stop	Harness
 <p>1 2 3 4 5 6</p>	 <p>19</p>	 <p>24</p>
 <p>7 8 9 10 11 12</p>	 <p>20</p>	
 <p>13</p>	 <p>21</p>	
 <p>14 15</p>	 <p>22</p>	
 <p>16 17 18</p>	 <p>23</p>	

0000-GXX-0373-A0

Approved Combinations

Select correct combination from the table according to the cutting attachment you intend to use.

WARNING

For safety reasons only the cutting attachments and deflectors or limit stops shown in each row of the table may be used together. No other combinations are permitted because of the **risk of accidents**.

Cutting attachments

Mowing heads

- 1 STIHL SuperCut 40-2
- 2 STIHL AutoCut 40-2
- 3 STIHL AutoCut 46-2
- 4 STIHL TrimCut 41-2
- 5 STIHL DuroCut 40-4
- 6 STIHL PolyCut 41-3

Metal cutting attachments

- 7 Grass cutting blade 230-4
(230 mm dia.)
- 8 Grass cutting blade 255-8
(255 mm dia.)
- 9 Grass cutting blade 250-40 Spezial
(250 mm dia.)
- 10 Grass cutting blade 250-44¹⁾
(250 mm dia.)
- 11 Brush knife 305-2 Spezial
(305 mm dia.)

- 12 Brush knife 300-3
(300 mm dia.)
- 13 Shredder blade 270-2
(270 mm dia.)
- 14 Scratcher tooth circular saw blade 200
(200 mm dia.)
- 15 Chisel tooth circular saw blade 200-22 (4119), chisel tooth circular saw blade 200-22 HP (4000)
- 16 Scratcher tooth circular saw blade 225
(225 mm dia.)
- 17 Chisel tooth circular saw blade 225
(225 mm dia.)
- 18 Carbide tipped circular saw blade 225
(225 mm dia.)

WARNING

Non-metal grass cutting blades, brush knives, shredder blades and circular saw blades are not approved.

Deflectors, Limit Stops

- 19 Deflector for mowing heads
- 20 Deflector for metal cutting attachments, items 7 to 12
- 21 Deflector for shredder blade
- 22 Limit stop for circular saw blades, items 14 and 15

¹⁾ approved for FS 260 and FS 360 only

- 23 Limit stop for circular saw blades, items 16 and 18

Harness

- 24 Full harness must be used

Mounting the Bike Handle

Mounting Bike Handle with Swiveling Handle Support

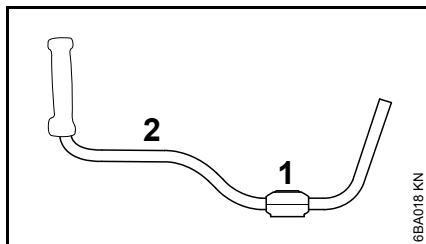

The machine is supplied with the clamp moldings (1) mounted to the handlebar (2).

Mounting the Control Handle

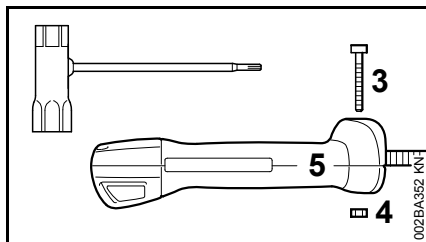

- Take out the screw (3) and remove the nut (4) from the control handle (5).

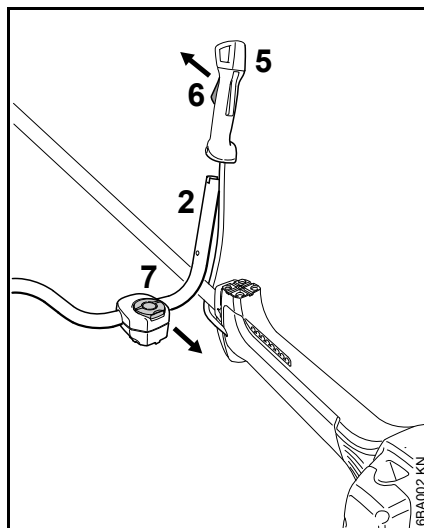

- Line up control handle (5) in relation to handlebar (2): Throttle trigger (6) must point toward the gearbox and the clamp screw (7) toward the engine.

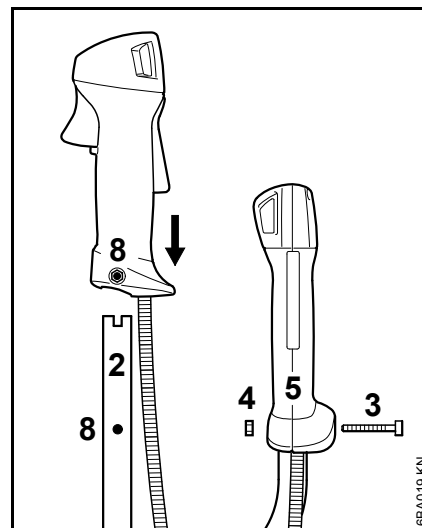

- Holding the control handle (5) in that position, push it on to the end of the handlebar (2) and line up the holes (8).
- Fit the nut (4) in the control handle (5), insert the screw (3) and tighten it down firmly.

Assembling the Handle Support

To assemble the swiveling handle support it is necessary to fit a spring in the clamps and secure them to the handle support on the machine.

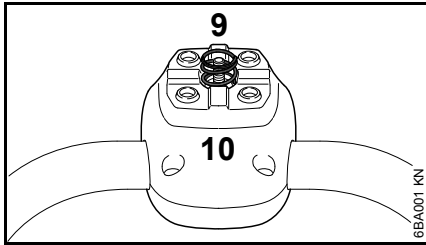

- Use the spring (9) from the parts kit supplied with the machine.
- Place the spring (9) in the lower clamp molding (10).

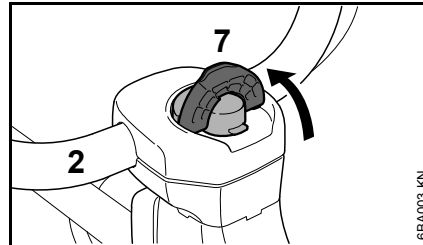

- Raise the grip of the wing screw (7) to the upright position.
- Turn the wing screw counterclockwise as far as stop.
- Push the wing screw into the handle support as far as stop and then screw it down – but do not finally tighten yet.
- Adjust the handlebar (2) so that distance A is no more than 15 cm.
- Line up the handlebar at a right angle to the drive tube.

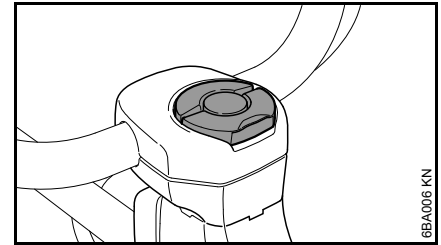

- Fold the grip of the wing screw down so that it is flush.

FS 260: Fitting the throttle cable



NOTICE

Do not kink the throttle cable or lay it in tight radii – make sure the throttle trigger moves freely.

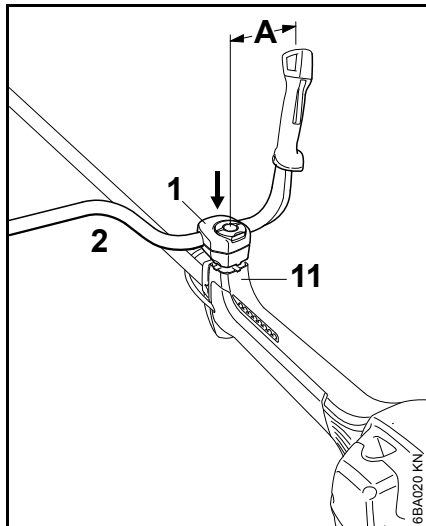

- Position the clamp moldings (1) with handlebar (2) on the handle support (11).

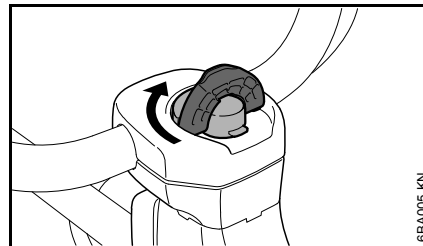

- Turn the wing screw clockwise as far as stop.

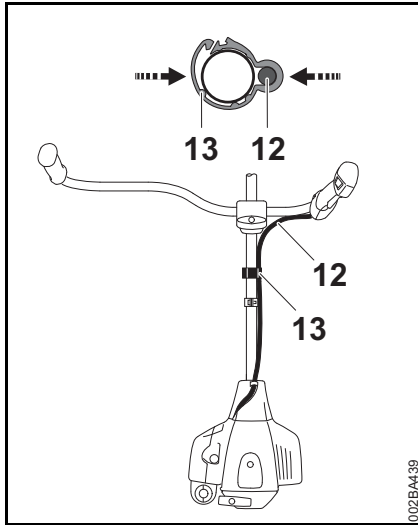

- Position the clamp (13) and handle support (12) against the drive tube.
- Close the throttle cable retainer (13). The retainer (13) snaps into place.

Adjusting the Handlebar

Opening the wing screw

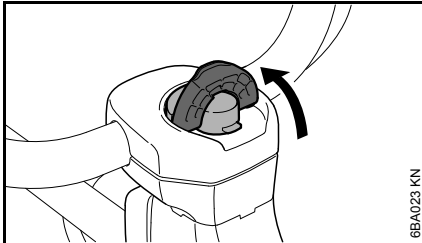

- Raise the grip of the wing screw to the upright position.

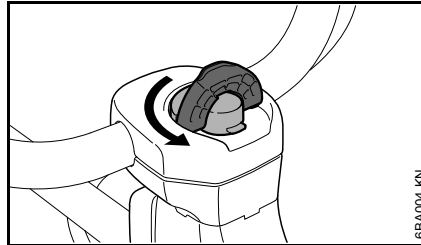

- Turn the wing screw counterclockwise until the handle support can be moved.

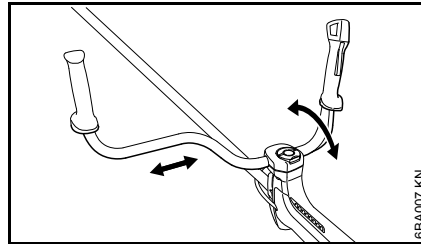

- Move the handlebar to the required position.

Closing the wing screw

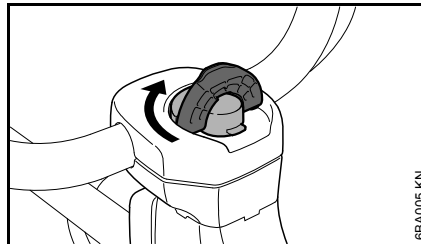

- Turn the wing screw clockwise as far as stop.

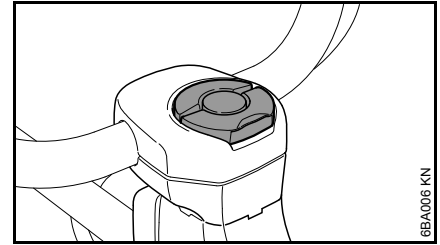

- Fold the grip of the wing screw down so that it is flush.

Swiveling the Handlebar

Transport position

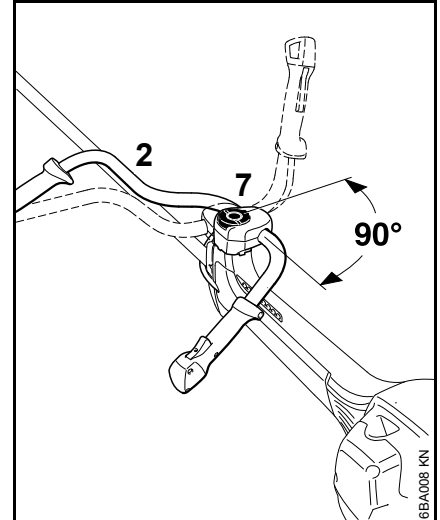

- Loosen the wing screw (7) and unscrew it until the handlebar (2) can be turned clockwise.
- Turn the handlebar 90° and then swing the handles down.
- Tighten down the wing screw (7) firmly.

Working position

- Reverse the sequence described above to swing the handles up and turn the handlebar counterclockwise.

Adjusting the Throttle Cable

It may be necessary to correct the adjustment of the throttle cable after assembling the machine or after a prolonged period of operation.

Adjust the throttle cable only when the unit is completely and properly assembled.

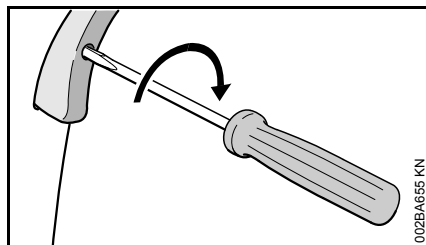

- Set the throttle trigger to the full throttle position.
- Carefully rotate the screw in the throttle trigger in the direction of the arrow until you feel initial resistance. Then rotate it another half turn in the same direction.

Mounting the Deflector

Use the Right Deflector

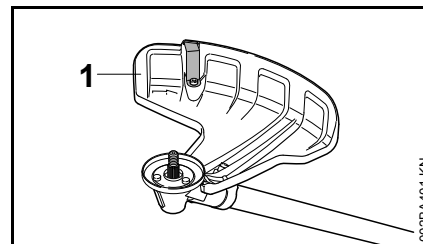

! WARNING

Deflector (1) is approved for mowing heads only and must therefore be mounted before fitting a mowing head.

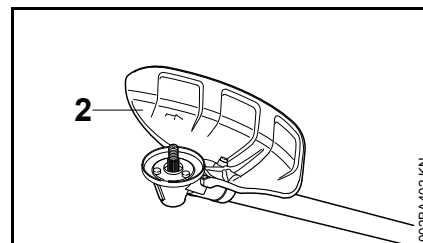

! WARNING

Deflector (2) is approved for grass cutting blades and brush knives only and must therefore be mounted before fitting a grass cutting blade or brush knife.

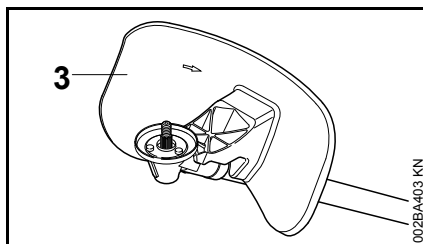

! WARNING

Deflector (3) is approved for shredder blades only and must therefore be mounted before fitting a shredder blade.

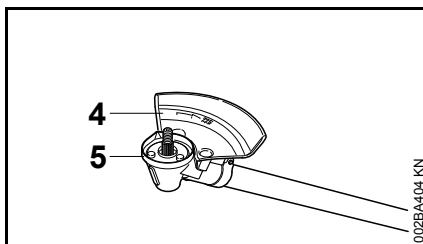

! WARNING

The limit stop (4) is approved as a deflector for circular saw blades only and must therefore be mounted before fitting a circular saw blade. It is also necessary to change the guard ring (5), see "Mounting the Cutting Attachment" / "Mounting Circular Saw Blades".

Mounting the Deflector

Deflectors (1 to 4) are mounted to the gearbox in the same way.

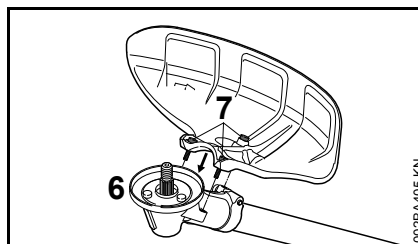

- Remove dirt from joints on gearbox and deflector – make sure that no dirt gets into the screw holes in the gearbox.
- Place the deflector on the gearbox (6).
- Insert the screws (7) and tighten them down firmly.

Mounting the Cutting Attachment

Placing power tool on the ground

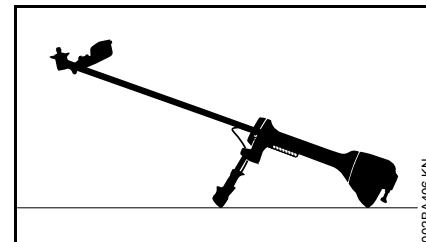

- Shut off the engine.
- Lay your power tool on its back so that the cutting attachment mounting face is pointing up.

Use the Right Guard Ring

Your power tool comes standard with a guard ring.

The guard ring is also available as a special accessory.

The guard ring must be mounted with particular care. Have this work performed by your servicing dealer. STIHL recommends a STIHL servicing dealer.

Guard ring for mowing applications

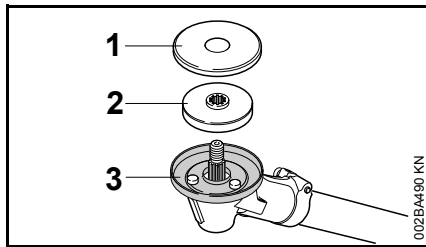

Always fit guard ring (1) when using

- mowing heads
- grass cutting blades
- brush knives
- shredder blades

to ensure optimum protection against grass cuttings.

Guard ring for sawing applications

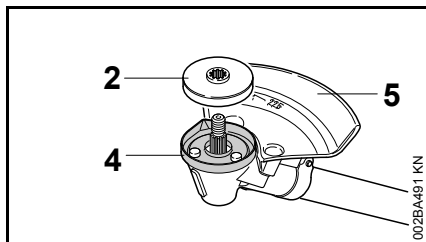

Fit guard ring (4) only when you use circular saw blades.

Mounting the Thrust Plate and Guard Washer

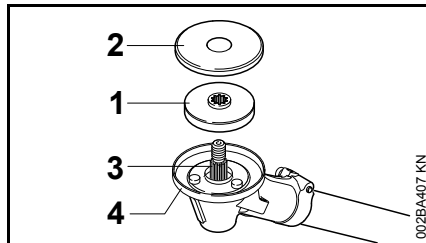

- Fit the thrust plate (1) and guard washer (2) on the shaft (3).



NOTICE

The thrust plate (1) on the gearbox is necessary for mounting all cutting attachments.



NOTICE

The guard washer (2) is required for mounting

- mowing heads
- grass cutting blades
- brush knives
- shredder blades

to the gearbox. The guard washer is not required for mounting circular saw blades.

Checking the Thrust Plate

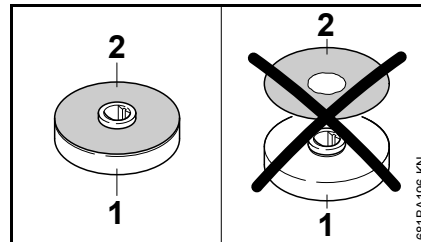

The thrust plate consists of the thrust plate body (1) to which a captive guard washer (2) is fitted.



WARNING

Never use a thrust plate without the guard washer. Always replace a thrust plate if the guard washer is missing.

Cleaning Gearbox Mounting Hardware for Cutting Attachment

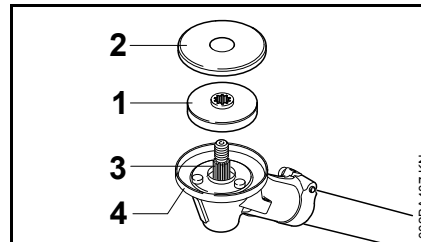

NOTICE

Check inside of guard ring (4) and area around it for dirt at regular intervals, or when you change the cutting attachment, and clean if necessary as follows:

- Pull the guard washer (1) and thrust plate (2) off the shaft.
- Thoroughly clean the guard ring, shaft, thrust plate and guard washer – do not remove the guard ring.

Blocking the Shaft

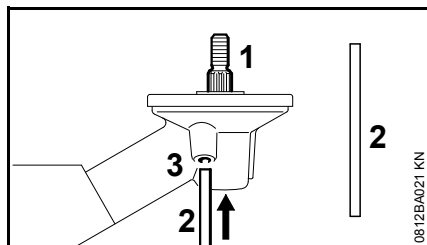

The output shaft (1) must be blocked with the stop pin (2) to mount or remove cutting attachments. The stop pin is included with the machine and is available as a special accessory.

- Insert the stop pin (2) in the bore (3) in the gearbox as far as stop, apply slight pressure.
- Rotate shaft or cutting attachment until the stop pin slips into position and blocks the shaft.

Mounting the Cutting Attachment

! WARNING

Use a deflector that matches the cutting attachment – see "Mounting the Deflector".

Fitting Mowing Head with Screw Mounting

Keep the instruction leaflet for the mowing head in a safe place.

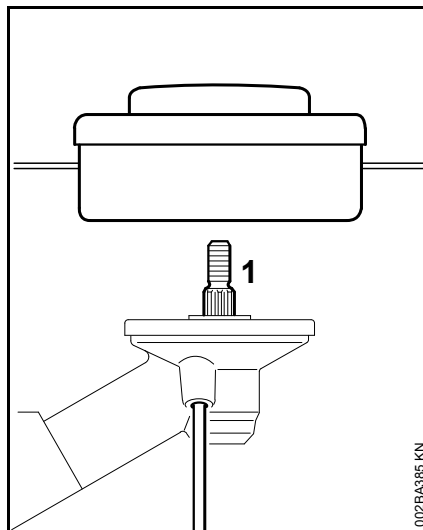

- Screw the mowing head counterclockwise on to the shaft (1) as far as stop.
- Block the shaft.
- Tighten down the mowing head firmly.

⚙ NOTICE

Remove the tool used to block the shaft.

Removing the Mowing Head

- Block the shaft.
- Unscrew the mowing head clockwise.

Removing and Installing Metal Cutting Attachments

Keep the leaflet and packaging of the metal cutting attachment in a safe place.

! WARNING

Wear protective gloves to reduce the risk of direct contact with the sharp cutting edges.

Mount only one metal cutting attachment.

Mounting Grass Cutting Blades, Brush Knife

Notice on new machines that come standard with a mowing head only: A "metal mowing attachment mounting kit" is required to mount a grass cutting blade or brush knife. Kits are available from your servicing dealer.

Check direction of rotation of cutting attachment

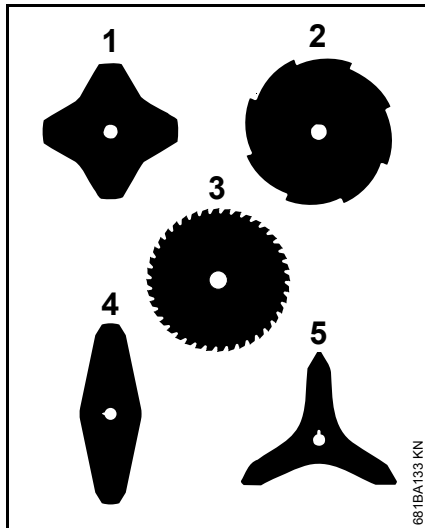

Cutting attachments 1, 4 and 5 may be mounted either way round – they must be turned over regularly to help avoid one-sided wear.

The cutting edges of cutting attachments 2 and 3 must point clockwise.

- Use guard ring for mowing attachments.

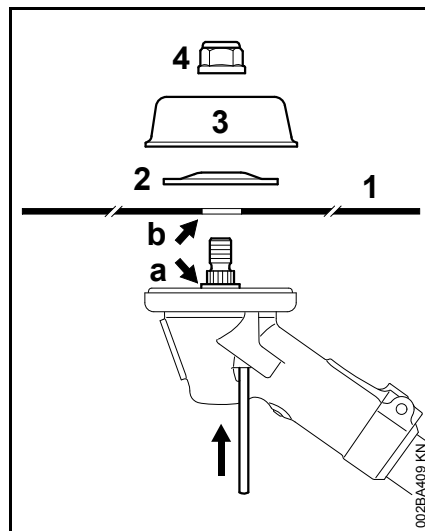

- Place the cutting attachment (1) in position.

WARNING

Collar (a) must locate in the cutting attachment's mounting hole (b).

Securing the cutting attachment

- Fit the thrust washer (2) – convex side must face up.
- Fit the rider plate (3).
- Block the shaft.
- Fit the nut (4) counterclockwise and tighten it down firmly.

WARNING

If the mounting nut has become too loose, fit a new one.

NOTICE

Remove the tool used to block the shaft.

Removing the cutting attachment

- Block the shaft.
- Unscrew the mounting nut clockwise.
- Pull the cutting attachment with its mounting hardware off the gearbox.

Mounting Shredder Blade 270-2

Notice on new machines that come standard with a mowing head only: In addition to the "shredder blade mounting kit", a "shredder blade retrofit kit" is required to mount a shredder blade. Kits are available from your servicing dealer.

- Use guard ring for mowing attachments.

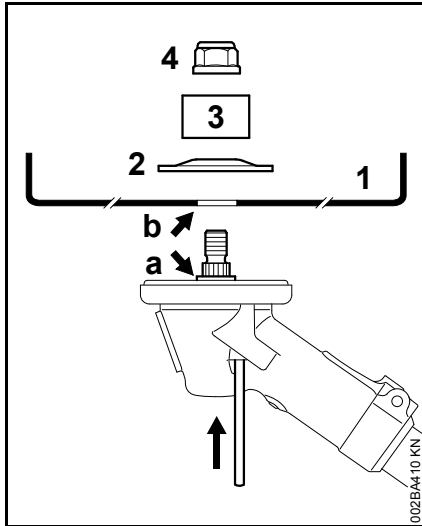

- Place the shredder blade (1) in position – the cutting edges must point upwards.

! WARNING

Collar (a) must locate in the cutting attachment's mounting hole (b).

Securing the cutting attachment

- Fit the thrust washer (2) – convex side must face up.
- Fit the shredder blade guard ring (3) – opening must face up.
- Block the shaft.
- Fit the nut (4) counterclockwise and tighten it down firmly.

! WARNING

If the mounting nut has become too loose, fit a new one.

⚙ NOTICE

Remove the tool used to block the shaft.

Removing the cutting attachment

- Block the shaft.
- Unscrew the mounting nut clockwise.
- Pull the cutting attachment with its mounting hardware off the gearbox.

Mounting Circular Saw Blades

A limit stop kit, which includes a limit stop and a guard ring for circular saw blades, is available as a special accessory for mounting circular saw blades.

Notice on new machines that come standard with a mowing head only: Further mounting hardware is necessary for a circular saw blade. It is available from your servicing dealer.

Change the guard ring.

Recommendation: The guard ring must be mounted with particular care. Have this work performed by your servicing dealer. STIHL recommends a STIHL servicing dealer.

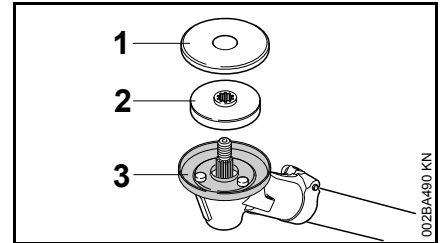

- Remove the guard washer (1) and thrust plate (2).
- Remove the guard ring (3) for mowing attachments.
- Keep the guard washer and guard ring in a safe place for future use.

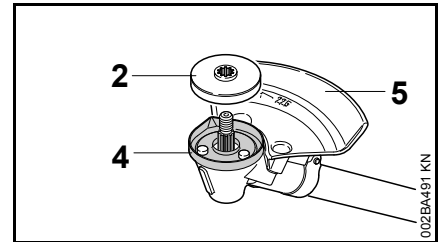

- Fit the guard ring (4) for saw blades.
- Slip the thrust plate (2) over the shaft.
- Fit the limit stop (5) for circular saw blades.

⚙ NOTICE

Do not use the guard washer (1) with circular saw blades.

Check direction of rotation of cutting attachment

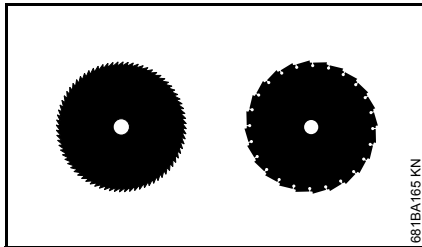

Cutting edges of circular saw blades must point clockwise.

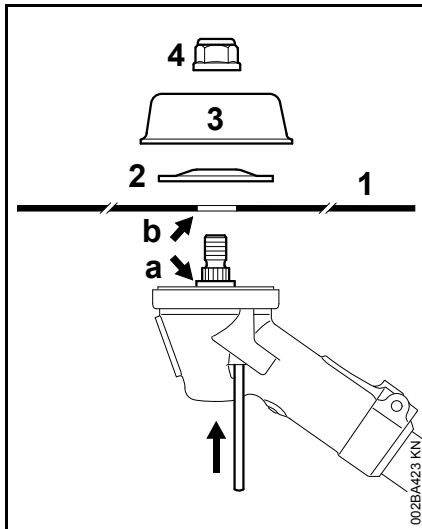

- Place the cutting attachment (1) in position.

WARNING

Collar (a) must locate in the cutting attachment's mounting hole (b).

Securing the cutting attachment

- Fit the thrust washer (2) – convex side must face up.
- Fit the rider plate (3).

A rider plate (3) for sawing applications is available as a special accessory. It allows the full depth of cut of the saw blade to be used.

- Block the shaft.
- Fit the nut (4) counterclockwise and tighten it down firmly.

WARNING

If the mounting nut has become too loose, fit a new one.

NOTICE

Remove the tool used to block the shaft.

Removing the cutting attachment

- Block the shaft.
- Unscrew the mounting nut clockwise.
- Pull the cutting attachment with its mounting hardware off the gearbox.

Fuel

Your engine requires a mixture of gasoline and engine oil.

WARNING

For health reasons, avoid direct skin contact with gasoline and avoid inhaling gasoline vapor.

STIHL MotoMix

STIHL recommends the use of STIHL MotoMix. This ready-to-use fuel mix contains no benzol or lead, has a high octane rating and ensures that you always use the right mix ratio.

STIHL MotoMix uses STIHL HP Ultra two-stroke engine oil for an extra long engine life.

MotoMix is not available in all markets.

Mixing Fuel

NOTICE

Unsuitable fuels or lubricants or mix ratios other than those specified may result in serious damage to the engine. Poor quality gasoline or engine oil may damage the engine, sealing rings, hoses and the fuel tank.

Gasoline

Use only high-quality **brand-name** gasoline with a minimum octane rating of 90 – leaded or unleaded.

Gasoline with an ethanol content of more than 10% can cause running problems in engines with a manually adjustable carburetor and should not be used in such engines.

Engines equipped with M-Tronic deliver full power when run on gasoline with an ethanol content of up to 25% (E25).

Engine Oil

If you mix the fuel yourself, use only STIHL two-stroke engine oil or another high-performance engine oil in accordance with JASO FB, JASO FC, JASO FD, ISO-L-EGB, ISO-L-EGC or ISO-L-EGD.

STIHL specifies STIHL HP Ultra two-stroke engine oil or an equivalent high-performance engine oil in order to maintain emission limits over the machine's service life.

Mix Ratio

STIHL 50:1 two-stroke engine oil: 50 parts gasoline to 1 part oil

Examples

Gasoline Liters	STIHL engine oil 50:1 Liters (ml)
1	0.02 (20)
5	0.10 (100)
10	0.20 (200)
15	0.30 (300)
20	0.40 (400)
25	0.50 (500)

- Use a canister approved for storing fuel. Pour oil into canister first, then add gasoline and mix thoroughly.

Storing Fuel

Store fuel only in approved safety-type fuel canisters in a dry, cool and safe location protected from light and the sun.

Fuel mix ages – only mix sufficient fuel for a few weeks work. Do not store fuel mix for longer than 30 days. Exposure to light, the sun, low or high temperatures can quickly make the fuel mix unusable.

STIHL MotoMix may be stored for up to 2 years without any problems.

- Thoroughly shake the mixture in the canister before fueling your machine.

WARNING

Pressure may build up in the canister – open it carefully.

- Clean the fuel tank and canister from time to time.

Dispose of remaining fuel and cleaning fluid properly in accordance with local regulations and environmental requirements.

Fueling

Fuel Filler Cap

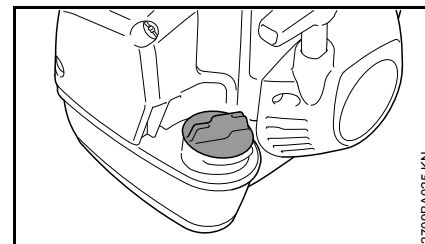

WARNING

When fueling on a slope, always position the machine with the filler cap facing uphill.

- Place the machine on level ground so that the filler cap is facing up.
- Before fueling, clean the filler cap and the area around it to ensure that no dirt falls into the tank.

Opening the filler cap

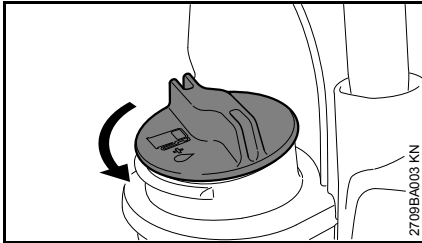

- Turn the cap counterclockwise until it can be removed from the tank opening.
- Remove the cap.

Filling Up with Fuel

Take care not to spill fuel while fueling and do not overfill the tank.

STIHL recommends you use the STIHL filler nozzle for fuel (special accessory).

- Fill up with fuel.

Closing the filler cap

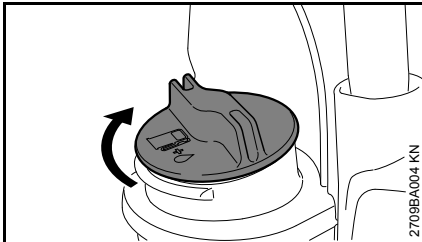

- Place the cap in the opening.
- Turn the cap clockwise as far as stop and tighten it down as firmly as possible by hand.

Fitting the Full Harness

Fitting the full harness is described in detail in the instruction sheet supplied.

The type and style of the harness depend on the market.

FS 260

Putting on the harness

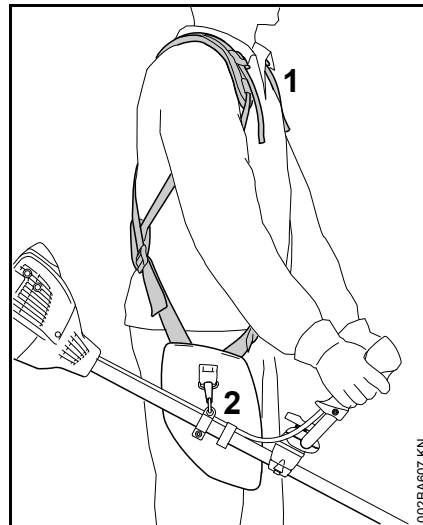

- Put on the full harness (1).
- Adjust the length of the strap so that the carabiner (2) is about a hand's width below your right hip.

Attaching machine to harness

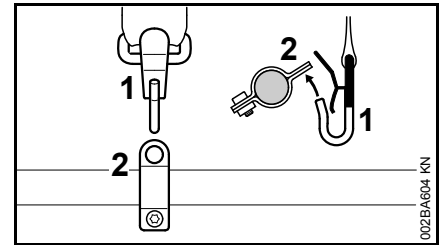

- Attach the carabiner (1) to the carrying ring (2) on the shaft.
- Balance the machine – see "Balancing the Machine".

Disconnecting machine from harness

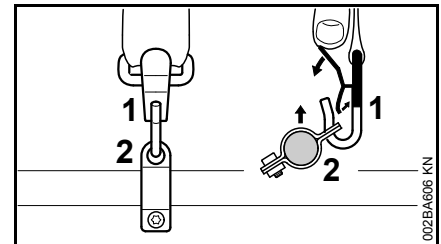

- Press down the bar on the carabiner (1) and pull the carrying ring (2) out of the carabiner.

FS 360

Putting on the harness

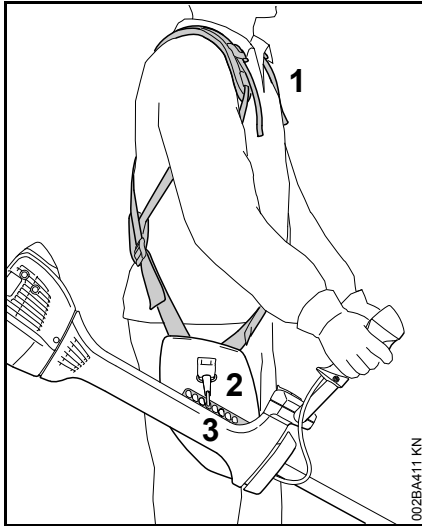

- Put on the full harness (1).
- Adjust the length of the strap so that the carabiner (2) is about a hand's width below your right hip.
- Attach the spring hook to the machine's perforated rail (3).
- Find the right attachment point for the cutting attachment you are using – see "Balancing the Machine".

Attaching machine to harness

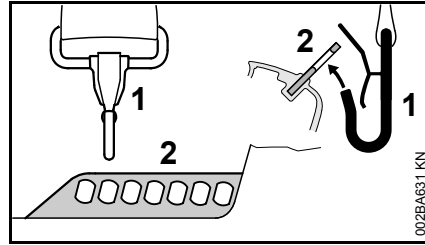

- Attach the carabiner (1) to the perforated rail (2) on the drive tube.

Disconnecting machine from harness

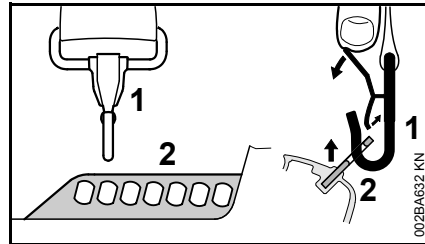

- Press down the bar on the carabiner (1) and pull the perforated rail (2) out of the carabiner.

Throwing Off the Machine

 **WARNING**

The machine must be quickly thrown off in the event of imminent danger. To throw off the machine, use the procedure described under "Detaching Machine from Harness". Practice removing and putting down the machine as you would in an emergency. To avoid damage, do not throw the power tool to the ground when practicing.

Practice slipping the harness off your shoulders.

Balancing the Machine

FS 260

Balanced positions

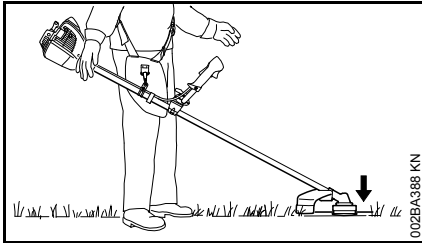

Mowing heads, grass cutting blades and brush knives and shredder blades should just touch the ground.

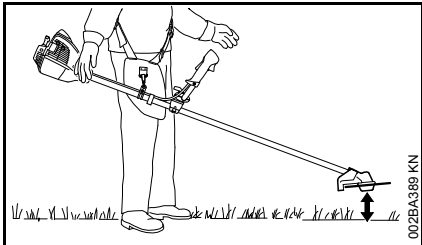

Circular saw blades should "hover" about 20 cm above the ground.

The correct balanced position is obtained as follows:

Balancing the Machine

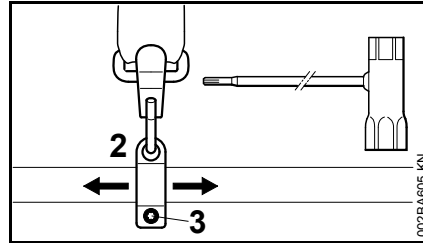

- Loosen the screw (3).
- Move the carrying ring (2) up or down the shaft – tighten the screw moderately – let the machine go and wait until it comes to a rest – then check the balanced position.

When the correct balanced position has been reached:

- Tighten down the screw on the carrying ring firmly.

FS 360

The unit is balanced differently depending on the cutting attachment used.

- With the unit suspended from the harness, see how it is balanced and change the attachment point as necessary:

Balanced positions

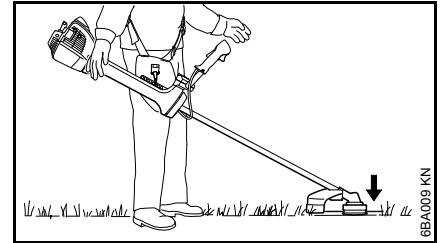

Mowing heads, grass cutting blades and brush knives and shredder blades should just touch the ground.

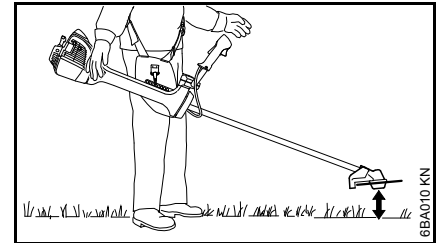

Circular saw blades should "hover" about 20 cm above the ground.

Starting / Stopping the Engine

Controls

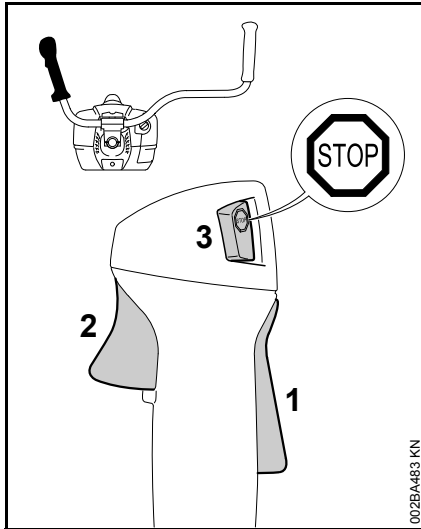

- 1 Throttle trigger lockout
- 2 Throttle trigger
- 3 Stop switch with **Run** and **Stop** positions. Depress the stop switch (⊖) to switch off the ignition.

Function of stop switch and ignition system

The stop switch is normally in the Run position, i.e. when it is **not** depressed: The ignition is switched on – the engine is ready to start. Operate the stop switch to switch off the ignition. The ignition is switched on again automatically after the engine stops.

Starting the Engine

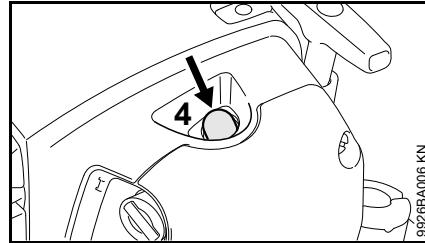

- Press the manual fuel pump bulb (4) at least five times – even if the bulb is filled with fuel.

Cold engine (cold start)

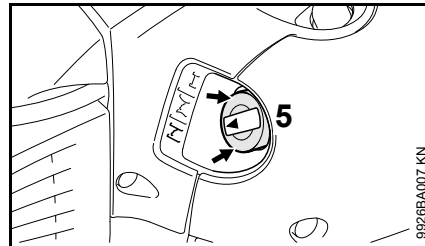

- Press in the rim (arrows) of the choke knob (5) and then turn it to **I**.

Also use this setting if the engine has been running but is still cold.

Hot engine (hot start)

The engine has reached normal operating temperature, then shut down and restarted after more than 5 minutes.

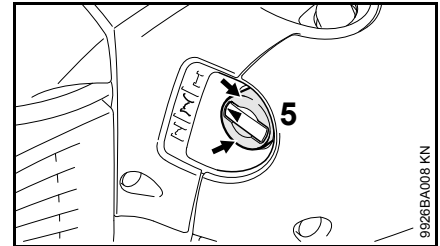

- Press in the outer edge (arrows) of the choke knob (5) and then turn it to **II**.

Cranking

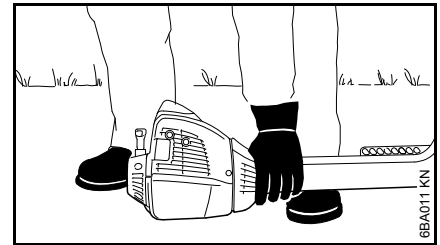

- Place the unit on the ground: It must rest securely on the engine's guard plate and the deflector.
- If fitted: Remove the transport guard from the cutting attachment.

To reduce the risk of accidents, check that the cutting attachment is not touching the ground of any other obstacles.

- Make sure you have a firm footing, either standing, stooping or kneeling.
- Hold the unit **firmly** on the ground with your left hand and press down – do not touch the throttle trigger or lockout lever – your thumb should be under the fan housing.

 NOTICE

Do not stand or kneel on the drive tube.

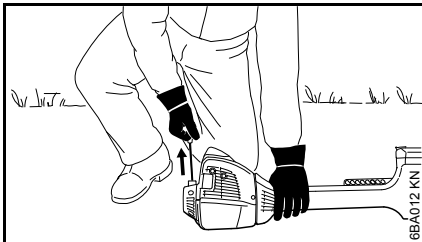

- Hold the starter grip with your right hand.

Alternative method of starting:

Engine warm and the machine hanging from the harness.

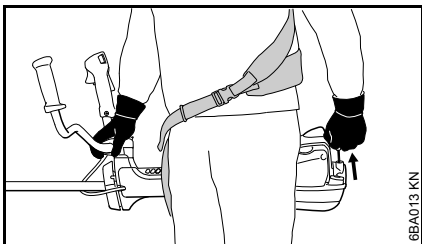

- Hold the machine firmly with your right hand on the drive tube, handle support or handlebar.
- With the machine behind you, press it against the left side of your body.
- Hold the starter grip with your left hand.

Both methods:

- Pull the starter grip steadily.

 NOTICE

Do not pull out the starter rope all the way – **it might otherwise break.**

- Do not let the starter grip snap back. Guide it slowly back into the housing so that the starter rope can rewind properly.
- Continue cranking until the engine runs.

As soon as the engine runs

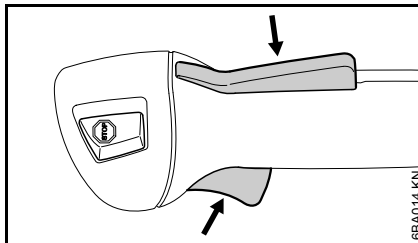

- Press down the throttle trigger lockout and open the throttle – the choke knob moves to the run position I. After a cold start, warm up the engine by opening the throttle several times.

 WARNING

Make sure the carburetor is correctly adjusted. The cutting attachment must not rotate when the engine is idling.

Your machine is now ready for operation.

Stopping the Engine

- Depress the momentary contact stop switch – the engine stops – release the stop switch – it springs back to the run position.

Other Hints on Starting

At very low outside temperatures

- Set the engine to winter operation if necessary, see "Winter Operation".
- If your machine is very cold (frost or ice on machine), start the engine and keep it at a high idle speed (cutting attachment rotates) until it reaches normal operating temperature.

Engine stalls in cold start position  or under acceleration

- Move the choke knob to  and continue cranking until the engine runs.

Engine does not start in hot start position 

- Move the choke knob to  and continue cranking until the engine runs.

If the engine does not start

- Check that all settings are correct.
- Check that there is fuel in the tank and refuel if necessary.
- Check that the spark plug boot is properly connected.
- Repeat the starting procedure.

Engine is flooded

- Move the choke knob to **I** and continue cranking until the engine runs.

Fuel tank run until completely dry

Recommendation: Carry out the following steps irrespective of the engine's operating condition before the tank was run dry.

- Turn the choke knob to **I**.
- Go to section on "Starting the Engine" and re-start the engine as described for a cold engine.

Transporting the Unit**Using Transport Guard**

The type of transport guard depends on the metal cutting attachment supplied with the machine. Transport guards are available as special accessories.

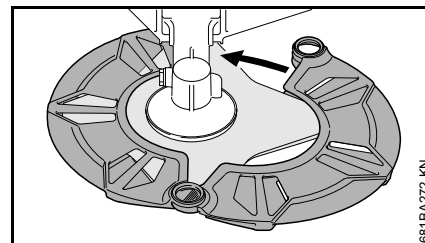
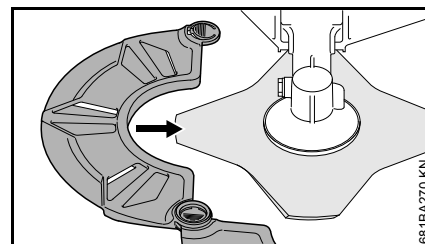
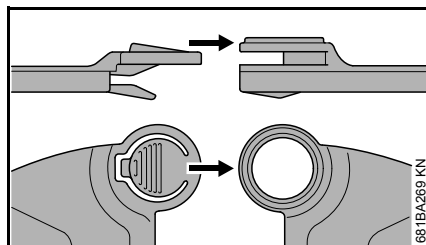
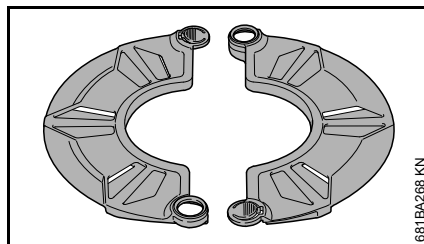
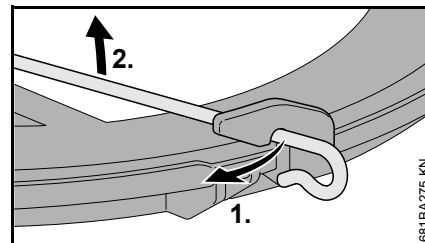
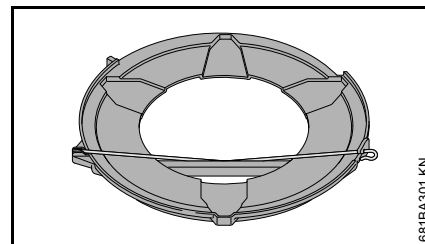
230 mm Grass Cutting Blades**Grass Cutting Blades up to 260 mm**

- Disconnect wire rod from the transport guard.

- Swing wire rod outwards.

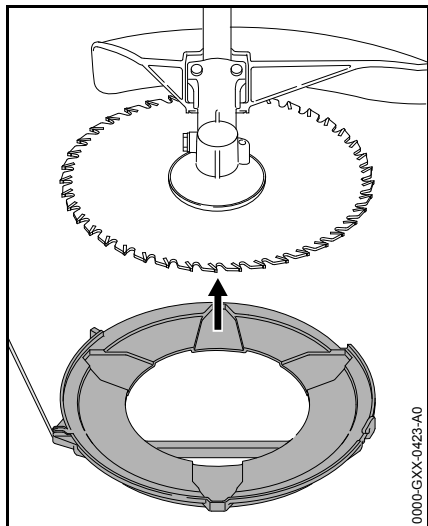

- Fit the transport guard on the cutting attachment from below.

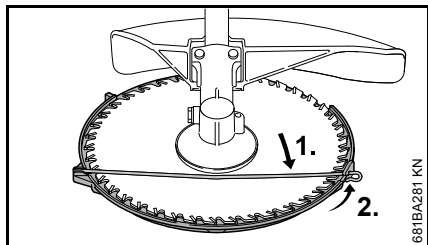

- Hook wire rod to the transport guard.
- Swing wire rod into position.

Circular Saw Blades

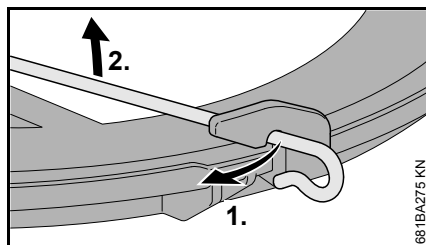
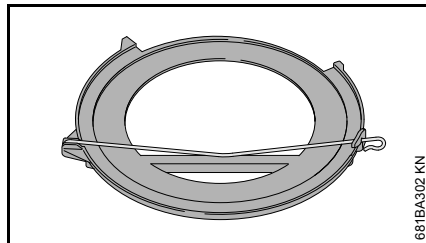

- Disconnect wire rod from the transport guard.

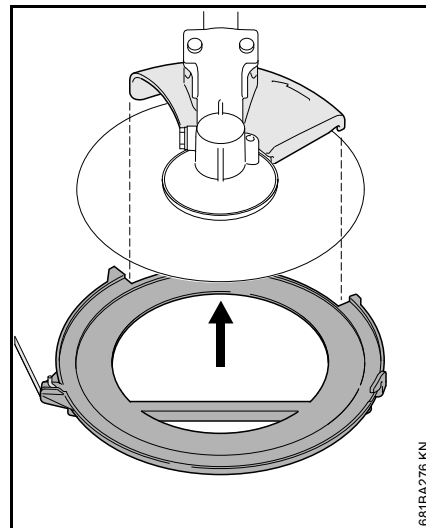

- Swing wire rod outwards.
- Fit transport guard on saw blade from below, making sure the limit stop is properly seated in the recess.

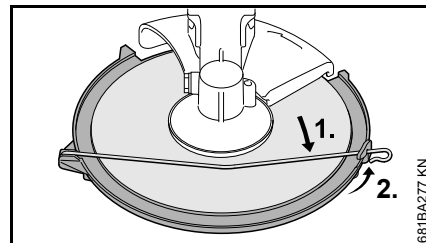

- Swing wire rod into position.
- Hook wire rod to the transport guard.

Universal Transport Guard

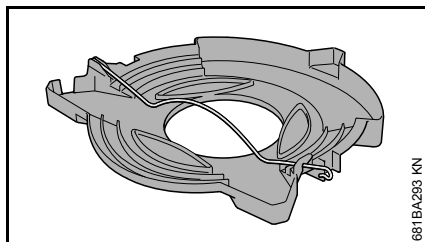

661BA293 KN

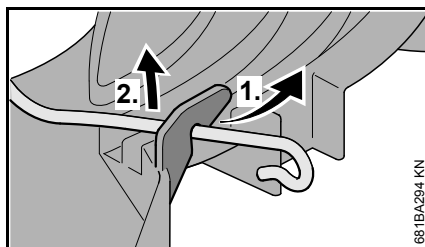

661BA294 KN

- Disconnect wire rod from the transport guard and swing it outwards.

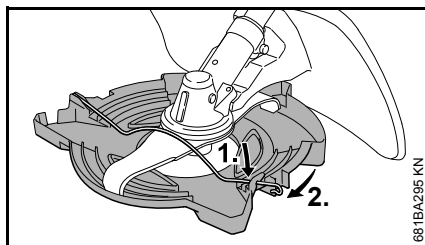

661BA295 KN

- Fit the transport guard on the cutting attachment from below.
- Attach wire rod to the hook on the transport guard.

Operating Instructions

During break-in period

A factory-new machine should not be run at high revs (full throttle off load) for the first three tank fillings. This avoids unnecessary high loads during the break-in period. As all moving parts have to bed in during the break-in period, the frictional resistances in the engine are greater during this period. The engine develops its maximum power after about 5 to 15 tank fillings.

During Operation

After a long period of full throttle operation, allow the engine to run for a short while at idle speed so that engine heat can be dissipated by the flow of cooling air. This protects engine-mounted components (ignition, carburetor) from thermal overload.

After Finishing Work

Storing for a short period: Wait for the engine to cool down. Empty the fuel tank and keep the machine in a dry place, well away from sources of ignition, until you need it again. For longer out-of-service periods – see "Storing the Machine".

Air filter

General Information

The filter has a very long service life.

Do not remove the filter cover or replace the air filter as long as there is no noticeable loss of power.

Dirty air filters reduce engine power, increase fuel consumption and make starting more difficult.

Replacing the Air Filter

Only if there is a noticeable loss of engine power

- Turn the choke knob to \bar{I} .

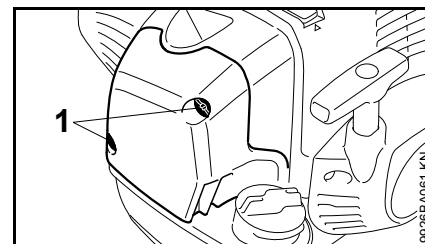

9926BA061 KN

- Loosen the screws (1).

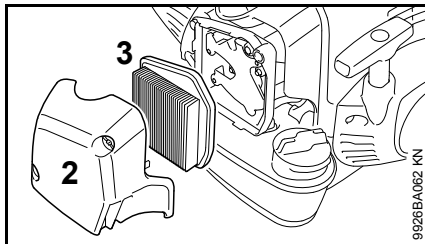

- Remove the filter cover (2).
- Clean away loose dirt from around the filter (3) and inside the filter cover.

The air filter (3) is a pleated paper filter element.

- Remove and check the filter element (3) – replace if paper or frame is dirty or damaged.
- Unpack the new filter.



NOTICE

Do not bend or twist the filter before installation as it might otherwise be damaged – do not use damaged filters.

- Fit the filter in the filter housing.
- Fit the filter cover.

Use only high quality air filters to ensure the engine is protected from abrasive dust.

STIHL recommends you use only original STIHL air filters. The high quality standard of these parts guarantees trouble-free operation, a long engine life and very long filter service lives.

Filter Element for Winter Operation

Maintenance and care of the special filter element for winter operation are described in the chapter on "Winter Operation".

Adjusting the Carburetor

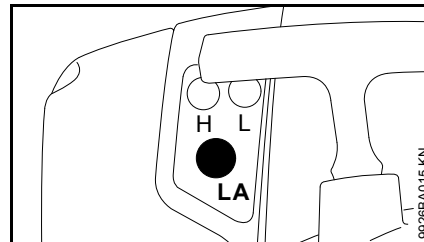

The carburetor has been set at the factory to provide an optimum fuel-air mixture under most operating conditions.

Adjusting idle speed

Engine stops while idling

- Turn the idle speed screw (LA) slowly clockwise until the engine runs smoothly.

Cutting tool rotates when engine is idling

- Turn the idle speed screw (LA) slowly counterclockwise until the cutting attachment stops moving.

Winter Operation

At temperatures below +10°C

Preheating the carburetor

Repositioning a shutter allows heated air to be drawn in from around the cylinder and mixed with cold air – this helps prevent carburetor icing.

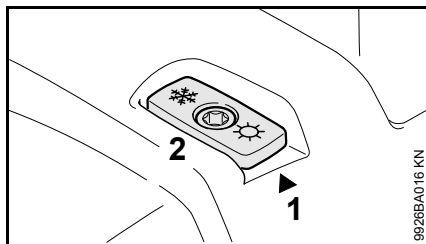

An arrow (1) on the shroud indicates the setting of the shutter (2) for summer or winter operation. Meaning of symbols:

- "Sun" = summer operation
- "Snowflake" = winter operation

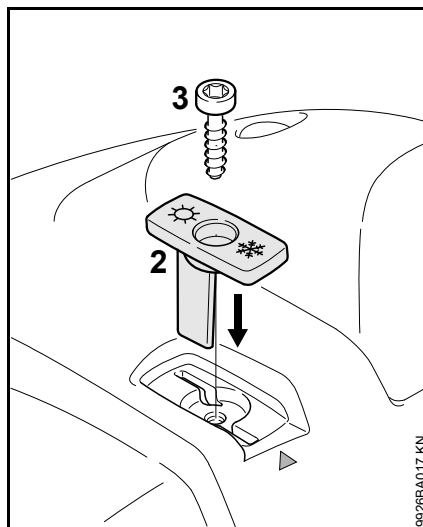

- Remove the screw (3) from the shutter.
- Pull the shutter (2) out of the shroud.
- Rotate the shutter (2) from the summer position to the winter position and refit it.
- Secure the shutter in position with the screw (3).

At temperatures between +10°C and +20°C

The machine can normally be operated in this temperature range with the shutter (2) in the summer position. Change the position of the shutter if necessary.

At temperatures above +20°C

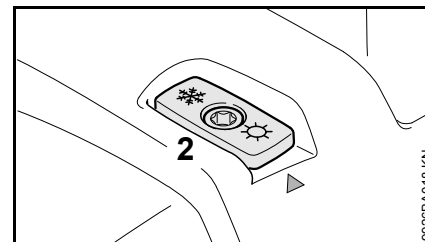

- Always return the shutter (2) to the summer position.

NOTICE

Do not operate the machine in the winter position at temperatures above +20°C because there is otherwise a risk of engine running problems and overheating.

At temperatures below -10°C

In extreme wintry conditions

- Temperatures below -10°C
- Powder or drifting snow

it is advisable to use the optional "cover plate kit".

Two different cover plate kits are available to suit the different tank caps.

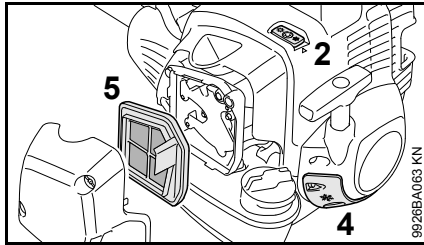

The cover plate kits contain the following parts for converting the power tool:

- 4 Cover plate partially blanks off the slots in the starter housing
- 5 Synthetic fabric filter element for the air filter
- Instructions for converting the machine

For machines with tank cap with hinged grip:

- O-ring for the tank filler cap

After installing the cover plate kit:

- Set the shutter (2) to the winter position.

At temperatures above -10°C

- Remove the parts of the cover plate kit and refit the standard parts for summer operation.

Note for machines with tank cap with hinged grip: The O-ring supplied with the cover plate kit can be left on the machine's tank cap.

Depending on the ambient temperature:

- Set the shutter (2) to the summer or winter position.

Cleaning the Air Filters

- Loosen filter cover mounting screws.
- Remove the filter cover.
- Clean away loose dirt from around the filter (5) and inside the filter cover.
- Knock the filter (5) out on the palm of your hand or blow it clear with compressed air from the inside outwards.

In case of stubborn dirt or sticky filter fabric:

- Wash the filter in a clean, non-flammable solution (e.g. warm soapy water) and then dry.

Always replace a damaged filter.

Spark Plug

- If the engine is down on power, difficult to start or runs poorly at idle speed, first check the spark plug.
- Fit a new spark plug after about 100 operating hours – or sooner if the electrodes are badly eroded. Install only suppressed spark plugs of the type approved by STIHL – see "Specifications".

Removing the Spark Plug

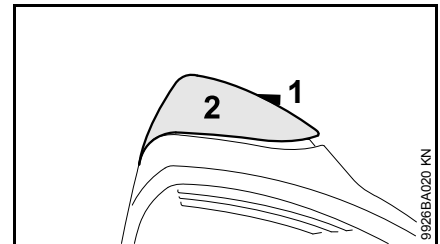

- Rotate the screw (1) in the cap (2) until the screw head projects from it.

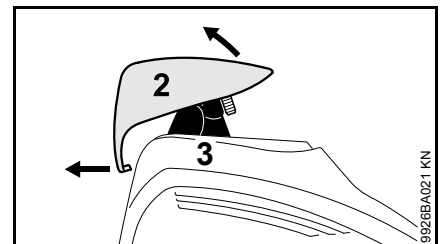

- Lift the front of the cap (2) and push it to the rear to disengage.
- Leave the cap to one side.
- Pull off the spark plug boot (3).
- Unscrew the spark plug.

Checking the Spark Plug

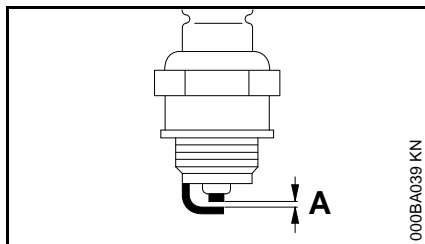

- Clean dirty spark plug.
- Check electrode gap (A) and readjust if necessary – see "Specifications".
- Rectify the problems which have caused fouling of the spark plug.

Possible causes are:

- Too much oil in fuel mix.
- Dirty air filter.
- Unfavorable running conditions.

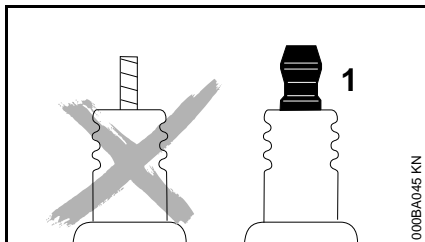

WARNING

Arcing may occur if the adapter nut (1) is loose or missing. Working in an easily combustible or explosive atmosphere may cause a fire or an explosion. This can result result in serious injuries or damage to property.

- Use resistor type spark plugs with a properly tightened adapter nut.

Installing the spark plug

- Screw in spark plug
- Firmly press the spark plug connector onto the spark plug.

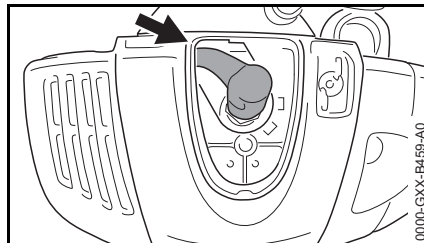

- Align the spark plug connector so that the ignition cable points to the upper left corner (arrow).

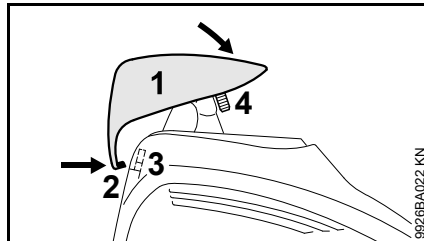

- Place the cap (1) on the hood from behind and at a slight angle, pressing the nose (2) into the opening (3) of the hood.
- On the front, swivel the cap onto the hood, screw in the screw (4) and tighten.

Engine Running Behavior

If engine running behavior is still unsatisfactory after the air filter has been serviced and the carburetor and throttle cable have been adjusted correctly, the cause may also be in the muffler.

Have the muffler checked for contamination (coking) by a servicing dealer!

STIHL recommends that maintenance and repair work be carried out only by authorized STIHL dealers.

Storing the Machine

If the machine is to remain out of use for approx. 3 months or more

- Drain and clean the fuel tank in a well ventilated place
- Dispose of fuel in accordance with the regulations and having regard for the environment
- Run the engine until the carburetor is dry. This helps to prevent the carburetor diaphragms sticking together.
- Remove, clean and inspect the cutting attachment. Treat metal cutting attachments with protective oil.
- Thoroughly clean the machine
- Store the machine in a dry and safe place, out of the reach of children and other unauthorized users

Sharpening Metal Cutting Blades

- Use a sharpening file (see "Special Accessories") to sharpen dull cutting attachments. In case of more serious wear or nicks: Resharpener with a grinder or have the work done by a dealer – STIHL recommends a STIHL servicing dealer.
- Sharpen frequently, take away as little metal as possible – two or three strokes of the file are usually enough.

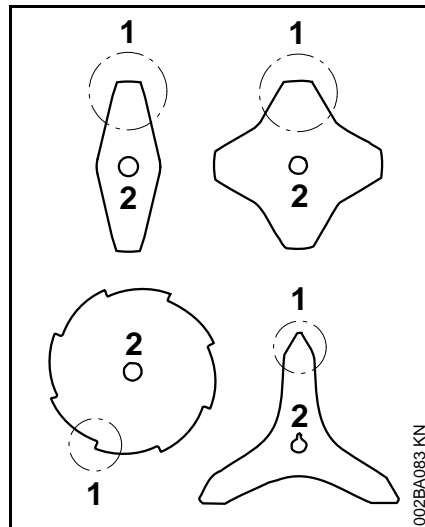

- Resharpener the teeth (1) uniformly – do not alter the contour of the parent blade (2) in any way.

See cutting attachment packaging for additional sharpening instructions. Keep the packaging for future reference.

Balancing

- After resharpening about 5 times, check the cutting attachment for out-of-balance on a STIHL balancer – see "Special Accessories" – or have it checked by a dealer and re-balanced as necessary – STIHL recommends a STIHL servicing dealer.

Maintaining the Mowing Head

Placing power tool on the ground

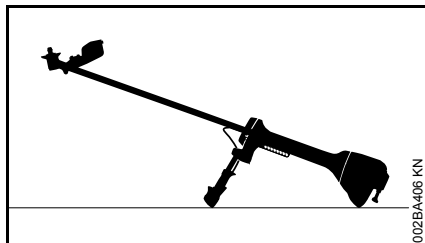

- Shut off the engine.
- Lay your power tool on its back so that the cutting attachment mounting face is pointing up.

Replacing Nylon Line

Always check the mowing head for signs of wear before replacing the nylon line.

! WARNING

If there are signs of serious wear, replace the complete mowing head.

The nylon mowing line is referred to as "nylon line" or "line" in the following.

The mowing head is supplied with illustrated instructions for replacing the nylon line. Keep the instructions for the mowing head in a safe place.

- If necessary, remove the mowing head.

Adjusting Nylon Line

STIHL SuperCut

Fresh line is advanced automatically if the remaining line is **at least 6 cm (2 1/2 in)** long. The blade on the deflector trims overlong lines to the correct length.

STIHL AutoCut

- With the engine running, hold the rotating mowing head above the grass surface.
- Tap it on the ground once – fresh line is advanced and the blade on the deflector trims it to the right length.

Fresh line is advanced every time the mowing head is tapped on the ground. For this reason observe the mowing head's cutting performance during operation. If the mowing head is tapped on the ground too often, the line limiting blade will unnecessarily cut off unused lengths of nylon line.

Line feed operates only if both lines are still at least **2.5 cm (1 in)** long.

STIHL TrimCut

! WARNING

To reduce the risk of injury, always shut off the engine before adjusting the nylon line by hand.

- Pull the spool up – rotate it about 1/6 turn counterclockwise until it engages – and allow it to spring back.
- Pull ends of the lines outward.

Repeat the above procedure as necessary until both lines reach the limiter blade on the deflector.

Rotating the spool from one stop to the next advances about **4 cm (1 1/2 in)** of fresh line.

Replacing Nylon Line

STIHL PolyCut

Precut lengths of nylon line can be fitted to the PolyCut in place of the cutting blades.

STIHL DuroCut, STIHL PolyCut

! WARNING

To reduce the risk of injury, always shut off the engine before refilling the mowing head.

- Fit precut lengths of nylon line in the mowing head as described in the instructions supplied.

Replacing Cutting Blades

STIHL PolyCut

Always check the mowing head for signs of wear before installing new cutting blades.

! WARNING

If there are signs of serious wear, replace the complete mowing head.

The thermoplastic cutting blades are referred to as "blades" in the following.

The mowing head is supplied with illustrated instructions for replacing the blades. Keep the instructions for the mowing head in a safe place.

! WARNING

To reduce the risk of injury, always shut off the engine before installing the blades.

- Remove the mowing head.
- Replace blades as shown in the illustrated instructions.
- Mount the mowing head on the machine.

Inspection and Maintenance by User

Clamped Area of Handlebar

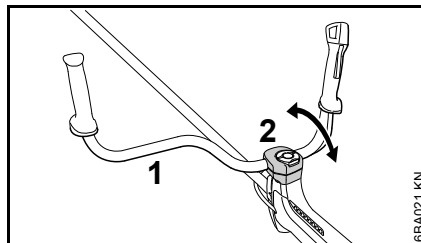

- Check the freedom of movement of the handlebar (1) in the clamp moldings (2) at regular intervals.

Handlebar is difficult to move

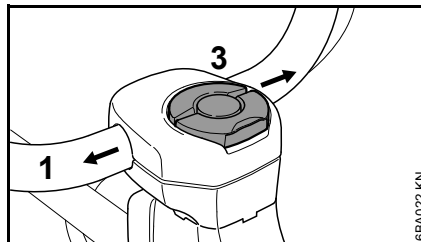

- Loosen the wing screw (3) just enough for the handlebar to be moved.
- Push the handlebar (1) sideways out of the clamp.
- Soak a cloth in a clean, non-flammable cleaning solution – do not use a cleaning agent containing oil or grease.

- Thoroughly clean the clamp area of the handlebar with the cloth and cleaning solution.
- Line up the handlebar and secure it in position with the wing screw.

Handlebar cannot be clamped firmly in position

- Release handlebar in clamp as described under "Handlebar is difficult to move".
- Degrease clamp area on handlebar and in clamp moldings.
- Line up the handlebar and secure it in position with the wing screw.

Inspections and Maintenance by Dealer

Maintenance Work

STIHL recommends that you have servicing and repair work carried out exclusively by an authorized STIHL servicing dealer.

Fuel Pickup Body in Tank

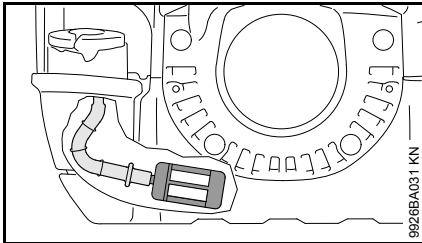

- Check the pickup body in the fuel tank every year and have it replaced if necessary.

The pickup body should be positioned in the area of the tank shown in the illustration.

Anti-vibration elements

FS 260

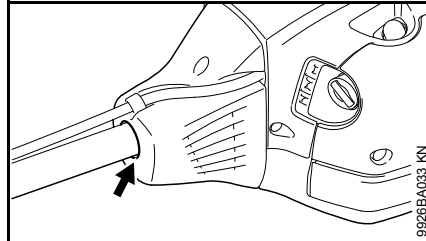

A vibration-absorbing rubber element is installed between the powerhead and the drive tube. Have it checked if there are signs of wear or a noticeable increase in vibration levels.

FS 360

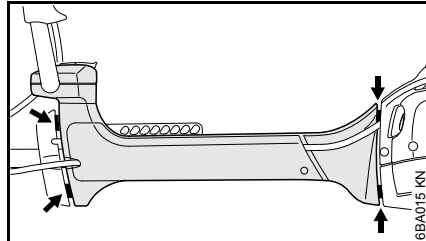

Four anti-vibration elements (arrows) are installed between the powerhead and the drive tube. Have the system checked if there is a noticeable increase in vibrations.

Both vibration gaps (arrows) are preset to the same width at the factory. If the size of the two vibration gaps varies greatly and/or one of them closes up, have your servicing dealer repair the anti-vibration system.

Wear guard on FS 360 anti-vibration housing

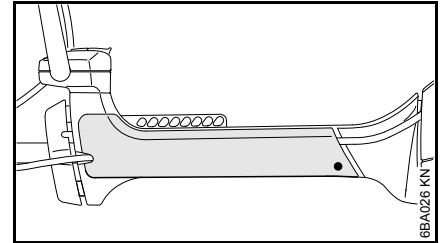

There is an easily replaced wear guard on the side of the anti-vibration housing. The guard may wear as a result of rubbing against the side plate of the harness during operation and should be replaced if necessary.

Maintenance and Care

The following intervals apply to normal operating conditions only. If your daily working time is longer or operating conditions are difficult (very dusty work area, etc.), shorten the specified intervals accordingly.		before starting work	after finishing work or daily	after each refueling stop	weekly	monthly	every 12 months	if problem	if damaged	as required
Complete machine	Visual inspection (condition, leaks)	X		X						
	Clean		X							
	Replace any damaged parts	X							X	
Control handle	Check operation	X		X						
Air filter, paper filter	Visual inspection							X		X
	Replace ¹⁾								X	
Air filter, synthetic fabric filter	Visual inspection					X		X		
	Clean									X
	Replace								X	X
Fuel tank	Clean					X		X		X
Manual fuel pump (if fitted)	Check	X								
	Repair ²⁾								X	
Pickup body in fuel tank	Check ²⁾							X		
	Replace ²⁾						X		X	X
Carburetor	Check idle adjustment – the cutting attachment must not rotate	X		X						
	Adjust idle speed									X
Spark plug	Adjust electrode gap							X		
	Replace after every 100 operating hours									
Cooling inlets	Visual inspection		X							
	Clean									X
Cylinder fins	Clean ²⁾						X			
Exhaust port	Decoke after first 139 hours of operation, then every 150 hours of operation ²⁾									X

The following intervals apply to normal operating conditions only. If your daily working time is longer or operating conditions are difficult (very dusty work area, etc.), shorten the specified intervals accordingly.		before starting work	after finishing work or daily	after each refueling stop	weekly	monthly	every 12 months	if problem	if damaged	as required
All accessible screws and nuts (not adjusting screws)	Retighten ³⁾									X
Anti-vibration elements	Visual inspection ⁴⁾	X						X		X
	Replace ²⁾								X	
Cutting attachment	Visual inspection	X		X						
	Replace								X	
	Check tightness	X		X						
Metal cutting attachment	Sharpen	X								X
Safety labels	Replace								X	

1) Only if there is a noticeable loss of engine power

2) STIHL recommends that this work be done by a STIHL servicing dealer

3) Tighten down the muffler mounting screws firmly after first 10 to 20 hours of operation.

4) see chapter "Inspections and Maintenance by Dealer", section "Antivibration Elements"

Minimize Wear and Avoid Damage

Observing the instructions in this manual helps reduce the risk of unnecessary wear and damage to the power tool.

The power tool must be operated, maintained and stored with the due care and attention described in this owner's manual.

The user is responsible for all damage caused by non-observance of the safety precautions, operating and maintenance instructions in this manual. This includes in particular:

- Alterations or modifications to the product not approved by STIHL.
- Using tools or accessories which are neither approved or suitable for the product or are of a poor quality.
- Using the product for purposes for which it was not designed.
- Using the product for sports or competitive events.
- Consequential damage caused by continuing to use the product with defective components.

Maintenance Work

All the operations described in the "Maintenance Chart" must be performed on a regular basis. If these maintenance operations cannot be performed by the owner, they should be performed by a servicing dealer.

STIHL recommends that you have servicing and repair work carried out exclusively by an authorized STIHL

servicing dealer. STIHL dealers are regularly given the opportunity to attend training courses and are supplied with the necessary technical information.

If these maintenance operations are not carried out as specified, the user assumes responsibility for any damage that may occur. Among other parts, this includes:

- Damage to the engine due to neglect or deficient maintenance (e.g. air and fuel filters), incorrect carburetor adjustment or inadequate cleaning of cooling air inlets (intake ports, cylinder fins).
- Corrosion and other consequential damage resulting from improper storage.
- Damage to the machine resulting from the use of poor quality replacement parts.

Parts Subject to Wear and Tear

Some parts of the power tool are subject to normal wear and tear even during regular operation in accordance with instructions and, depending on the type and duration of use, have to be replaced in good time. Among other parts, this includes:

- Cutting attachments (all types)
- Mounting hardware for cutting attachments (rider plate, nut, etc.)
- Deflectors for cutting attachments
- Clutch
- Filters (air, fuel)
- Rewind starter

- Throttle cable
- Spark plug
- Antivibration elements
- Wear guard on antivibration housing

Main Parts

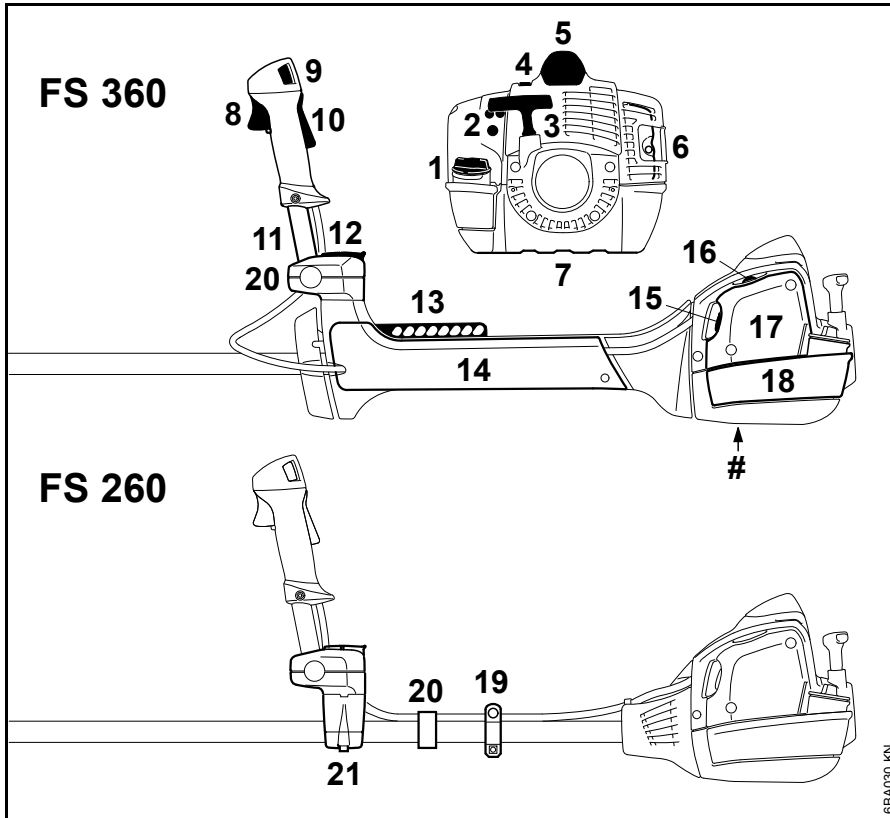

- 1 Tank cap
- 2 Carburetor adjusting screw
- 3 Starter grip
- 4 Shutter (winter operation)
- 5 Spark plug boot
- 6 Muffler
- 7 Guard plate
- 8 Throttle trigger
- 9 Stop switch
- 10 Throttle trigger lockout
- 11 Handlebar
- 12 Clamp screw
- 13 Carrying strip
- 14 Wear guard
- 15 Choke lever
- 16 Manual fuel pump
- 17 Filter cover
- 18 Fuel tank
- 19 Carrying ring
- 20 Throttle cable retainer
- 21 Handle support
- # Serial number

6BA030 KN

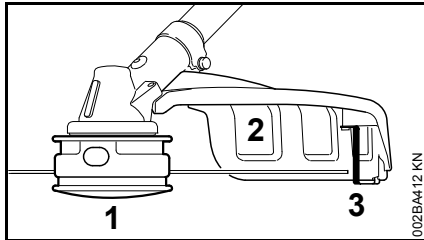

- 1 Mowing head
- 2 Deflector for mowing heads only
- 3 Blade

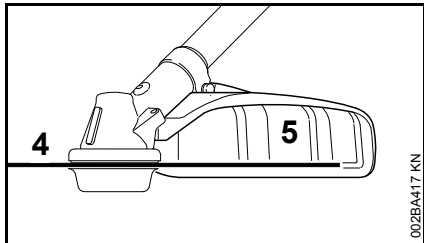

- 4 Metal mowing attachment
- 5 Deflector (for metal mowing attachments only)

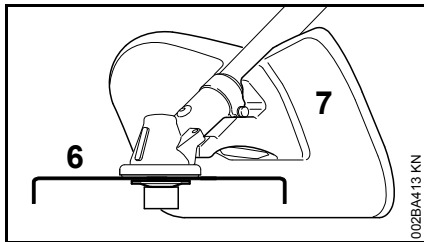

- 6 Shredder blade
- 7 Shredder deflector (only for shredding with shredder blades)

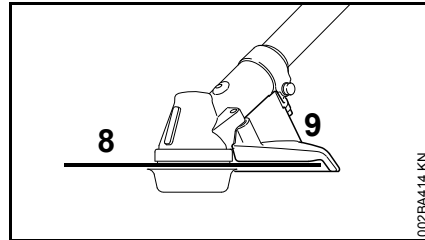

- 8 Circular Saw Blade
- 9 Limit stop (for circular saw blades only)

Specifications

Engine

Single cylinder two-stroke engine

FS 260, FS 260 C

Displacement:	41.6 cc
Bore:	42 mm
Stroke:	30 mm
Engine power to ISO 8893:	2.0 kW (2.7 bhp) at 9,000 rpm
Idle speed:	2,800 rpm
Cut-off speed (rated):	12,500 rpm
Max. output shaft speed (cutting attachment):	9,000 rpm

FS 360 C

Displacement:	37.7 cc
Bore:	40 mm
Stroke:	30 mm
Engine power to ISO 8893:	1.7 kW (2.3 bhp) at 8,500 rpm
Idle speed:	2,800 rpm
Cut-off speed (rated):	12,500 rpm
Max. output shaft speed (cutting attachment):	9,000 rpm

Ignition System

Electronic magneto ignition

Spark plug (resistor type):	NGK CMR6H
Electrode gap:	0.5 mm

Fuel System

All position diaphragm carburetor with integral fuel pump

Fuel tank capacity: 750 cc (0.75 l)

Weight

Dry, without cutting attachment and deflector

FS 260: 7.5 kg

FS 260 C-E: 7.7 kg

FS 360 C-E: 8.5 kg

Overall length

without cutting attachment

FS 260: 1685 mm

FS 260 C-E: 1685 mm

FS 360 C-E: 1790 mm

Features

C Convenience features

E ErgoStart

Noise and Vibration Data

Noise and vibration data measurements on FS units include idling and rated maximum speed with the same duration of exposure.

For further details on compliance with Vibration Directive 2002/44/EC see www.stihl.com/vib.

Sound pressure level L_p to ISO 22868

with mowing head

FS 260: 102 dB(A)

FS 260 C: 101 dB(A)

FS 360 C: 99 dB(A)

with metal mowing attachment

FS 260: 100 dB(A)

FS 260 C: 100 dB(A)

FS 360 C: 98 dB(A)

Sound power level L_w to ISO 22868

with mowing head

FS 260: 114 dB(A)

FS 260 C: 113 dB(A)

FS 360 C: 112 dB(A)

with metal mowing attachment

FS 260: 111 dB(A)

FS 260 C: 112 dB(A)

FS 360 C: 110 dB(A)

Vibration measurement $a_{hv,eq}$ to ISO 22867

with mowing head Handle, left Handle, right

FS 260: 5.8 m/s² 5.7 m/s²

FS 260 C: 5.8 m/s² 5.7 m/s²

FS 360 C: 2.5 m/s² 2.0 m/s²

with metal mowing attachment Handle, left Handle, right

FS 260: 4.2 m/s² 4.6 m/s²

FS 260 C: 4.2 m/s² 4.6 m/s²

FS 360 C: 2.2 m/s² 1.8 m/s²

The K-factor in accordance with Directive 2006/42/EC is 2.0 dB(A) for the sound pressure level and sound power level; the K-factor in accordance with Directive 2006/42/EC is 2.0 m/s² for the vibration level.

REACH

REACH is an EC regulation and stands for the Registration, Evaluation, Authorisation and Restriction of Chemical substances.

For information on compliance with the REACH regulation (EC) No. 1907/2006 see www.stihl.com/reach.

Exhaust Emissions

The CO₂ value measured in the EU type approval procedure is specified at www.stihl.com/co2.

The measured CO₂ value was determined on a representative engine in accordance with a standardized test procedure under laboratory conditions and does not represent either an explicit or implied guarantee of the performance of a specific engine.

The applicable exhaust emission requirements are fulfilled by the intended usage and maintenance described in this instruction manual. The type approval expires if the engine is modified in any way.

Maintenance and Repairs

Users of this machine may only carry out the maintenance and service work described in this user manual. All other repairs must be carried out by a servicing dealer.

STIHL recommends that you have servicing and repair work carried out exclusively by an authorized STIHL servicing dealer. STIHL dealers are regularly given the opportunity to attend training courses and are supplied with the necessary technical information.

When repairing the machine, only use replacement parts which have been approved by STIHL for this power tool or are technically identical. Only use high-quality replacement parts in order to avoid the risk of accidents and damage to the machine.

STIHL recommends the use of original STIHL replacement parts.

Original STIHL parts can be identified by the STIHL part number, the **STIHL** logo and the STIHL parts symbol  (the symbol may appear alone on small parts).

Disposal

Observe all country-specific waste disposal rules and regulations.

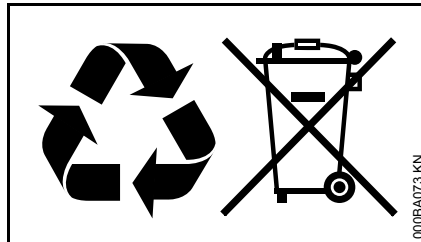

STIHL products must not be thrown in the garbage can. Take the product, accessories and packaging to an approved disposal site for environment-friendly recycling.

Contact your STIHL servicing dealer for the latest information on waste disposal.

EC Declaration of Conformity

ANDREAS STIHL AG & Co. KG
Badstr. 115
D-71336 Waiblingen

Germany

declare in exclusive responsibility that the product

Category:	Clearing saw
Make:	STIHL
Model:	FS 260
	FS 260 C
	FS 260 C-E
	FS 360 C
	FS 360 C-E

Serial identification: 4147

Displacement

all FS 260: 41.6 cc

all FS 360: 37.7 cc

conforms to the provisions of Directives 2011/65/EU, 2006/42/EC, 2014/30/EU and 2000/14/EC and has been developed and manufactured in compliance with the following standards in the versions valid at the time of production:

EN ISO 11806-1, EN 55012,
EN 61000-6-1

The measured and guaranteed sound power levels were determined according to Directive 2000/14/EC, Annex V, using the ISO 10884 standard.

Measured sound power level

FS 260: 114 dB(A)

FS 260 C: 113 dB(A)

FS 360 C: 112 dB(A)

Guaranteed sound power level

FS 260: 116 dB(A)

FS 260 C: 115 dB(A)

FS 360 C: 114 dB(A)

Technical documents deposited at:

ANDREAS STIHL AG & Co. KG
Produktzulassung (Product Licensing)

The year of manufacture and serial
number are applied to the product.

Done at Waiblingen, 27.11.2018

ANDREAS STIHL AG & Co. KG



Thomas Elsner

Director Product Management and
Services



0458-743-0121-C

englisch



www.stihl.com



0458-743-0121-C