

# STIHL

## STIHL MS 231, 251

Instruction Manual





# Contents

|  |    |   |    |
|--|----|---|----|
| Guide to Using this Manual                         | 2  | Checking and Replacing the Chain Sprocket | 38 |
| Safety Precautions                                 | 3  | Maintaining and Sharpening the Saw Chain  | 39 |
| Reactive Forces                                    | 8  | Maintenance and Care                      | 43 |
| Working Techniques                                 | 9  | Main Parts                                | 45 |
| Cutting Attachment                                 | 18 | Specifications                            | 46 |
| Mounting the Bar and Chain (side chain tensioner)  | 18 | Ordering Spare Parts                      | 47 |
| Mounting the Bar and Chain (quick chain tensioner) | 19 | Maintenance and Repairs                   | 48 |
| Tensioning the Saw Chain (side chain tensioner)    | 21 | Disposal                                  | 48 |
| Tensioning the Saw Chain (quick chain tensioner)   | 22 | EC Declaration of Conformity              | 48 |
| Checking Chain Tension                             | 22 |   |    |
| Fuel   | 22 |   |    |
| Fueling  | 23 |   |    |
| Chain Lubricant                                    | 25 |   |    |
| Filling Chain Oil Tank                             | 25 |   |    |
| Checking Chain Lubrication                         | 26 |   |    |
| Chain Brake  | 26 |   |    |
| Winter Operation                                   | 27 |   |    |
| Starting / Stopping the Engine                     | 28 |   |    |
| Operating Instructions                             | 32 |   |    |
| Taking Care of the Guide Bar                       | 33 |   |    |
| Shroud   | 34 |   |    |
| Air Filter System                                  | 34 |   |    |
| Cleaning the Air Filter                            | 34 |   |    |
| Adjusting the Carburetor                           | 35 |   |    |
| Spark Arresting Screen in Muffler                  | 36 |   |    |
| Spark Plug   | 37 |   |    |
| Storing the Machine                                | 38 |   |    |

**Dear Customer,**

**Thank you for choosing a quality engineered STIHL product.**

**It has been built using modern production techniques and comprehensive quality assurance. Every effort has been made to ensure your satisfaction and trouble-free use of the product.**

**Please contact your dealer or our sales company if you have any queries concerning this product.**

**Your**



**Dr. Nikolas Stihl**

# STIHL

This instruction manual is protected by copyright. All rights reserved, especially the rights to reproduce, translate and process with electronic systems.

## Guide to Using this Manual

This Instruction Manual refers to a STIHL chain saw, also called a machine in this Instruction Manual.

### Pictograms

Pictograms that appear on the machine are explained in this Instruction Manual.

Depending on the machine and equipment version, the following pictograms may appear on the machine.



Fuel tank; fuel mixture of gasoline and engine oil



Tank for chain oil; chain oil



Engage and release chain brake



Coasting brake



Direction of chain travel



Ematic; chain oil flow adjustment



Tension saw chain



Intake air baffle: winter operation



Intake air baffle: summer operation



Handle heating



Actuate decompression valve

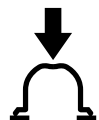

Actuate manual fuel pump

### Symbols in text



**WARNING**

Warning where there is a risk of an accident or personal injury or serious damage to property.



**NOTICE**

Caution where there is a risk of damaging the machine or its individual components.

### Engineering improvements

STIHL's philosophy is to continually improve all of its products. For this reason we may modify the design, engineering and appearance of our products periodically.

Therefore, some changes, modifications and improvements may not be covered in this manual.

## Safety Precautions



Special safety precautions must be observed to reduce the risk of personal injury when working with a chain saw because of the very high chain speed and very sharp cutters.



It is important that you read the instruction manual before first use and keep it in a safe place for future reference. Non-observance of the instruction manual may result in serious or even fatal injury.

### General

Observe all applicable local safety regulations, standards and ordinances.

The use of noise emitting power tools may be restricted to certain times by national or local regulations.

If you have not used this model before: Have your dealer or other experienced user show you how to operate your machine or attend a special course in its operation.

Minors should never be allowed to use a chain saw.

Keep bystanders, especially children, and animals away from the work area.

The user is responsible for avoiding injury to third parties or damage to their property.

Do not lend or rent your chain saw without the instruction manual. Be sure that anyone using it understands the information contained in this manual.

To operate a chain saw you must be rested, in good physical condition and mental health. If you have any condition that might be aggravated by strenuous work, check with your doctor before operating a chain saw.

Do not operate the chain saw if you are under the influence of any substance (drugs, alcohol) which might impair vision, dexterity or judgment.

To reduce the risk of accidents or injury, put off the work in poor weather conditions (rain, snow, ice, wind).

Persons with pacemakers only: The ignition system of your chain saw produces an electromagnetic field of a very low intensity. This field may interfere with some pacemakers. To reduce health risks, STIHL recommends that persons with pacemakers consult their physician and the pacemaker manufacturer before operating this power tool.

### Intended use

The machine may only be used to saw wood and wooden objects.

Do not use the machine for any other purpose – risk of accidents!

Do not modify the machine in any way – this may increase the risk of personal injury. STIHL excludes all liability for personal injury and damage to property caused while using unauthorised attachments.

## Clothing and Equipment

Wear proper protective clothing and equipment.



Clothing must be sturdy and snug-fitting, but allow complete freedom of movement. Wear snug fitting clothing with **cut-retardant pads** – no loose-fitting jacket.

Avoid clothing that could get caught on branches, brush or moving parts of the machine. Do not wear a scarf, necktie or jewellery. Tie up and confine long hair (headscarf, cap, hard hat, etc.).



Wear suitable **safety shoes** – with cut-retardant material, non-slip soles and steel toe caps.



### WARNING



To reduce the risk of eye injuries, wear tight-fitting safety goggles conforming to standard EN 166 or a face shield. Make sure that the safety goggles and the face shield fit correctly.

Wear "personal" hearing protection – for example, ear defenders.

Wear a hard hat wherever there is any risk of falling objects.



Wear sturdy protective gloves made of a resistant material (e.g. leather).

STIHL can supply a comprehensive range of personal protective equipment.

## Transport

Before any transport – even over short distances – switch off the machine, engage the chain brake and attach the chain scabbard. This avoids the risk of the saw chain starting unintentionally.

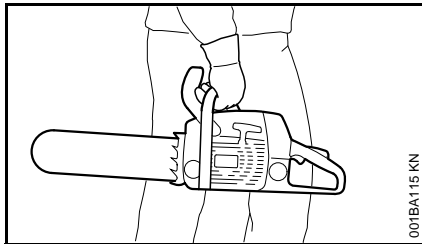

Always carry the chain saw by the handle – with the hot muffler away from your body, the guide bar must point to the rear. Avoid touching hot parts of the machine, especially the surface of the muffler – risk of burns!

In vehicles: Properly secure the machine to prevent tipping, damage and chain oil or fuel spillage.

## Cleaning

Clean plastic parts with a cloth. Harsh detergents can damage the plastic.

Clean the dust and dirt off the machine – do not use any grease solvents for this purpose.

Clean the ventilation slots if necessary.

Do not use a high-pressure cleaner to clean the machine. The hard jet of water can damage parts of the machine.

## Accessories

Only use those tools, guide bars, chains, chain sprockets, accessories or technically equivalent components that have been approved by STIHL for this machine. If you have any questions in this respect, consult a servicing dealer. Use only high quality tools and accessories. Otherwise, there may be a risk of accidents and damage to the machine.

STIHL recommends the use of genuine STIHL tools, guide bars, chains, chain sprockets and accessories. They are specifically designed to match your model and meet your performance requirements.

## Refuelling



**Gasoline is an extremely flammable fuel** – keep clear of naked flames and fire – do not spill any fuel – no smoking.

Switch off the engine before refuelling.

Never refuel the machine while the engine is still hot – the fuel may spill over – **risk of fire!**

Open the fuel filler cap carefully so that any excess pressure is relieved gradually and fuel does not splash out.

The machine may only be refuelled in a well ventilated place. Clean the machine immediately if fuel is spilled. Do not spill fuel over your clothing – contaminated clothing must be changed immediately.

The machines can be equipped with the following filler caps as standard:

### Cliplock filler cap (bayonet-type)

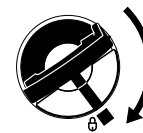

Place the cliplock filler cap (bayonet-type) in position, turn as far as stop and fold the cliplock down.

This helps reduce the risk of unit vibrations causing an incorrectly tightened filler cap to loosen or come off and spill quantities of fuel.



Look out for leaks! Never start the engine if fuel has been spilled or is leaking – **Fatal burns may result!**

## Before Starting Work

Check that your saw is properly assembled and in good condition – refer to appropriate chapters in the instruction manual.

- Check the fuel system for leaks, paying special attention to visible parts such as the tank cap, hose connections and the manual fuel pump (on machines so equipped). If

there are any leaks or damage, do not start the engine – **risk of fire**. Have your saw repaired by a servicing dealer before using it again.

- Check operation of chain brake, front hand guard
- Correctly mounted guide bar
- Correctly tensioned chain
- The trigger and trigger lockout must move freely and spring back to the idle position when they are released.
- Master Control lever must move easily to **STOP, 0** or  $\odot$
- Check that the spark plug boot is secure – a loose boot may cause arcing that could ignite combustible fumes **and cause a fire**.
- Never attempt to modify the controls or safety devices in any way.
- Keep the handles dry and clean – free from oil and dirt – for safe control of the saw.
- Make sure there is sufficient fuel and chain oil in the tanks.

**To reduce the risk of personal injury**, do not operate your saw if it is damaged or not properly assembled.

### Starting the chain saw

Always work on a level surface. Ensure a firm and secure footing. Hold the machine securely – the chain must not touch any objects or the floor – danger of injury due to the rotating saw chain.

Your chain saw is a one-person saw. Do not allow other persons to be in the working area – not even while starting.

Do not start the chain saw if the chain is in a cut.

Move at least 3 meters away from the place where the machine was refuelled and never start the motor in enclosed spaces.

Lock the chain with the chain brake before starting – **risk of injury** due to rotating chain!

Do not drop-start the engine – start as described in the Instruction Manual.

### During operation

Ensure you always have a firm and safe footing. Take special care when the bark is wet – **danger of slipping!**

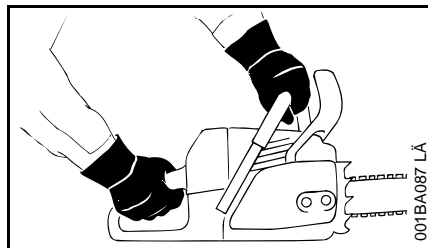

Always hold the chain saw **firmly with both hands**: Right hand on the rear handle – even if you are left-handed. To ensure reliable control, wrap your thumbs tightly around the handlebar and handle.

In the event of impending danger or in an emergency, switch off the engine immediately by moving the Master Control lever / stop switch to **STOP, 0** or  $\odot$ .

Never let the machine run unattended.

Exercise caution with slippery surfaces, water, snow, ice, steep slopes, uneven ground or green wood that has just been stripped of its bark – **danger of slipping!**

Use caution with tree stumps, roots, ditches – **danger of stumbling!**

Do not work alone – keep within calling distance of others who are trained in emergency procedures and can provide help in an emergency. Helpers at the cutting site must also wear protective clothing (helmet!) and stand well clear of the branches being cut.

More care and attention than usual are required when wearing ear protection, as warning sounds (shouts, beeps, etc.) cannot be heard properly.

Take a break in good time to avoid tiredness or exhaustion – **risk of accidents!**

Dust (e. g., sawdust), fumes and smoke produced while using the machine may be hazardous to health. If dust is generated, wear a dust mask.

When the engine is running: Note that the saw chain continues to rotate for a short period after you let go of the throttle trigger – coasting effect.

**No smoking** when working with or near the chain saw - **risk of fire!** Combustible fuel vapour may escape from the fuel system.

Examine the saw chain periodically at short intervals and as soon as you note any tangible changes:

- Switch off the engine; wait until the saw chain is stationary
- Check condition and secure fitting
- Check sharpness

Never touch the saw chain when the engine is running. If the saw chain becomes jammed by an object, switch off the engine immediately before attempting to remove the object – **risk of injury!**

Always turn off the engine before leaving the machine unattended.

To change the saw chain, switch off the engine. **Risk of injury** from the motor starting unintentionally!

Keep easily combustible materials (e. g., wood chips, bark, dry grass, fuel) away from hot exhaust gases and hot mufflers – **risk of fire!** Mufflers with catalytic converters can become especially hot.

Never work without chain lubrication – monitor the oil level in the oil tank. Stop work immediately if the oil level in the oil tank is too low and top up with chain oil – see also "Topping up with chain oil" and "Check chain lubrication".

If the machine is subjected to unusually high loads for which it was not designed (e. g., heavy impact or a fall), always check that it is in good condition before continuing work – see also "Before starting work".

Check the fuel system for leaks and make sure the safety devices are working properly. Never continue using

a machine that is not in perfect working order. In case of doubt, have the unit checked by your servicing dealer.

Check for correct idling, so that the saw chain stops moving when the throttle trigger is released. Check the idle setting regularly and correct when possible. Have the machine repaired by a STIHL servicing dealer if the saw chain still continues to move during idling.



The chain saw produces poisonous exhaust gases as soon as the engine starts. These gases may be colourless and odourless and may contain unburnt hydrocarbons and benzene. Never work with the machine indoors or in poorly ventilated areas, even if your machine is equipped with a catalytic converter.

Ensure proper ventilation when working in trenches, hollows or other confined locations – **risk of fatal injury from breathing toxic fumes!**

If you feel sick, have a headache, vision problems (e. g., your field of vision gets smaller), hearing problems, dizziness or inability to concentrate, stop work immediately. Such symptoms may be caused by an excessively high concentration of exhaust emissions – **risk of accident!**

#### After finishing work

Switch off the motor, engage the chain brake and attach the chain scabbard.

#### Storage

When the machine is not in use, it should be stored in such a way that no-one is endangered. Secure the machine against unauthorised use.

Store the machine in a safe, dry room.

#### Vibrations

Prolonged use of the power tool may result in vibration-induced circulation problems in the hands (whitefinger disease).

No general recommendation can be given for the length of usage because it depends on several factors.

The period of usage is prolonged by:

- Hand protection (wearing warm gloves)
- Work breaks

The period of usage is shortened by:

- Any personal tendency to suffer from poor circulation (symptoms: frequently cold fingers, tingling sensations).
- Low outside temperatures.
- The force with which the handles are held (a tight grip restricts circulation).

Continual and regular users should monitor closely the condition of their hands and fingers. If any of the above symptoms appear (e.g. tingling sensation in fingers), seek medical advice.



## Maintenance and repairs

Always switch off the engine before any repair, cleaning or maintenance work and any work on the chain. **Risk of injury** if the engine starts inadvertently!

Exception: adjustment of carburettor and idle speed.

The machine must be serviced regularly. Do not attempt any maintenance or repair work not described in the Instruction Manual. All other work should be carried out by a servicing dealer.

STIHL recommends that maintenance and repair work be carried out only by authorised STIHL dealers. STIHL dealers receive regular training and are supplied with technical information.

Use only high-quality spare parts. Otherwise, there may be a risk of accidents and damage to the machine. If you have any questions in this respect, consult a servicing dealer.

Do not modify the machine in any way – this may increase the risk of personal injury –**risk of accidents!**

To reduce the **risk of fire** due to ignition outside the cylinder, move the master control level to **STOP, 0** or  $\odot$  before turning the engine over on the starter when the spark plug boot is removed or the spark plug is unscrewed!

Do not service or store the machine near a naked flame – **risk of fire** due to the fuel.

Check fuel cap regularly for tightness.

Use only spark plugs that are in perfect condition and have been approved by STIHL – see "Specifications".

Check ignition lead (insulation in good condition, secure connection).

Check that the muffler is in perfect working condition.

Do not use the machine if the muffler is damaged or missing – **risk of fire, damage to hearing!**

Never touch a hot muffler – **risk of burns!**

The condition of the anti-vibration elements influences vibration behaviour – inspect anti-vibration elements periodically.

**Inspect chain catcher** – replace if damaged.

### **Switch off the engine**

- To check the chain tension
- To retension the chain
- To replace the chain
- For remedying malfunctions

**Observe sharpening instructions** – for safe and proper handling, always keep the chain and guide bar in flawless condition. Keep the chain properly sharpened, tensioned and well lubricated.

Change chain, guide bar and chain sprocket in due time.

Regularly check that the clutch drum is in perfect working condition.

Always store fuel and chain lubricant only in the specified type of containers and ensure they are correctly labelled. Store in a dry, cool and secure place protected against light and sunlight.

In the event of a chain brake malfunction, switch off the machine immediately – **risk of injury!** Consult a

servicing dealer – do not use the machine until the malfunction has been remedied, see "Chain brake".

## Reactive Forces

The most common reactive forces are: kickback, pushback and pull-in.

### Dangers of kickback



Kickback can result in fatal cuts.

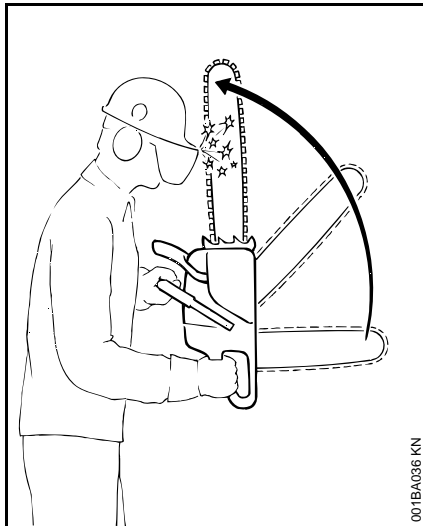

Kickback occurs when the saw is suddenly thrown up and back in an uncontrolled arc towards the operator.

### Kickback occurs if, for example,

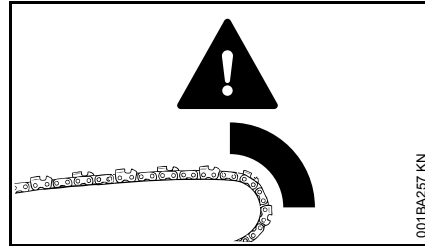

- The saw chain in the area of the upper quarter of the guide bar nose unintentionally comes into contact with wood or a solid object – e. g., unintentionally touches another limb during limbing
- The saw chain at the nose of the guide bar is briefly pinched in the cut

### QuickStop chain brake:

This device reduces the risk of injury in certain situations – it cannot prevent kickback. If activated, the brake stops the saw chain within a fraction of a second – refer to chapter "Chain brake" in this Instruction Manual.

### Reducing the risk of kickback

- Work cautiously and methodically
- Hold the chain saw firmly with both hands and maintain a secure grip
- Always cut at full throttle
- Be aware of the location of the guide bar nose
- Do not cut with the guide bar nose

- Be especially careful with small, tough limbs, undergrowth and offshoots – the saw chain may become caught in them
- Never cut several limbs at once
- Do not lean too far forward
- Do not cut above shoulder height
- Use extreme caution when re-entering a previous cut
- Do not attempt plunge cuts if you are not experienced in this cutting technique
- Be alert for shifting of the log or other forces that may cause the cut to close and pinch the chain
- Always cut with a correctly sharpened, properly tensioned saw chain – the depth gauge setting must not be too large
- Use low-kickback saw chains as well as narrow-radius guide bars

### Pull-in (A)

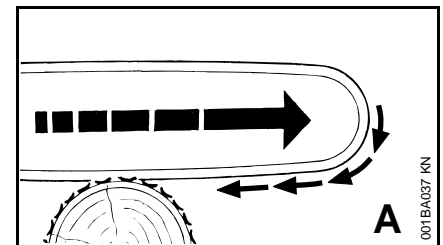

When the chain on the bottom of the bar – overbucking – is suddenly pinched, caught or encounters a foreign object in the wood, the chain saw may suddenly

be drawn forward toward the log – **to avoid this, engage the bumper spike firmly in the wood.**

### Pushback (B)

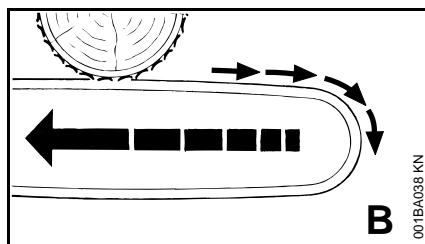

When the chain on the top of the bar – underbucking – is suddenly pinched, caught or encounters a foreign object in the wood, the chain saw may suddenly be driven straight back toward the operator – **to avoid this:**

- Do not allow the top of the guide bar to become jammed
- Do not twist the guide bar in the cut

### Be very careful

- With freely hanging limbs
- With trunks that are under tension between other trees because they fell unfavourably
- When working in windbreaks

In these cases, do not use a chain saw – use a hoist, winch or dragline instead.

Pull out trunks that are lying about and have been cut free. Whenever possible, deal with them in open areas.

**Dead wood** (brittle, rotten or dead wood) poses a significant, highly unpredictable hazard. It is extremely difficult or even practically impossible to recognise the danger. Use aids such as winches or draglines.

When **felling close to roads, rail lines, power lines**, etc., work with particular care. If necessary, notify police, power companies or railway authorities.

## Working Techniques

Sawing and felling work, including all related work (plunge cutting, limbing, etc.) may only be carried out by persons who have been specially trained and instructed. Persons who are not experienced chain saw users should not carry out any such work – increased risk of accidents!

Country-specific legislation on felling technique must be complied with during felling work.

### Cutting

Do not operate your saw with the starting throttle lock engaged. Engine speed cannot be controlled with the throttle trigger in this position.

Work calmly and carefully – in daylight conditions and only when visibility is good. Ensure you do not endanger others – stay alert at all times.

First-time users are advised to practice cutting logs on a sawhorse – see "When cutting small logs".

Use the shortest possible guide bar: The chain, guide bar and chain sprocket must match each other and your saw.

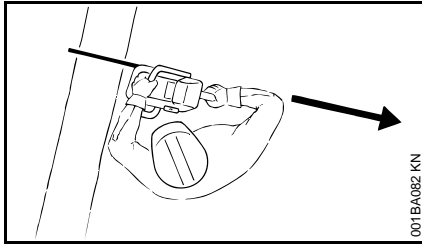

Position the saw so that your body is **clear of the cutting attachment.**

Always pull the saw out of the cut with the chain running.

Use your chain saw for cutting only. It is not designed for prying or shoveling away limbs, roots or other objects.

Do not underbuck freely hanging limbs.

Take care when cutting scrub and young trees. The saw chain may catch and throw thin shoots in your direction.

**To reduce the risk of injury**, take special care when cutting shattered wood because of the risk of injury from splinters being caught and thrown in your direction.

Make sure your saw does not touch any foreign materials: Stones, nails, etc. may be flung off and damage the saw chain. The saw may kick back unexpectedly – **risk of accidents.**

If the rotating chain makes contact with a rock or other solid object there is a risk of sparking which may cause easily combustible material to catch fire under certain circumstances. Dry plants and scrub are also easily combustible, especially in hot and dry weather conditions. If there is a risk of fire, do not use your chainsaw near combustible

materials, dry plants or scrub. Always contact your local forest authority for information on a possible fire risk.

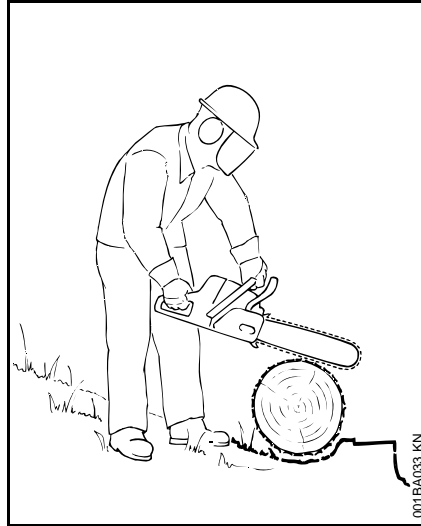

If on a slope, stand on the uphill side of the log. Watch out for rolling logs.

#### **When working at heights:**

- Always use a lift bucket
- Never work on a ladder or in a tree
- Never work on an insecure support
- Do not work above shoulder height
- Never operate your power tool with one hand

Begin cutting with the saw at full throttle and engage the spiked bumper firmly in the wood, and then continue cutting.

Never work without the spiked bumper because the saw may pull you forwards and off balance. Always engage the spiked bumper securely in the tree or limb.

Note when reaching the end of a cut that the saw is no longer supported in the kerf. You have to take the full weight of the machine since **it might otherwise go out of control.**

#### **When cutting small logs:**

- Use a sturdy and stable support – sawhorse.
- Never hold the log with your leg or foot.
- Never allow another person to hold the log or help in any other way.

#### **Limbing:**

- Use a low kickback chain.
- Work with the saw supported wherever possible.
- Do not stand on the log while limbing it.
- Do not cut with the bar nose.
- Watch for limbs which are under tension.
- Never cut several limbs at once.

#### **Lying or standing logs under tension:**

Always make cuts in the correct sequence (first at the compression side (1), then at the tension side (2), the saw may otherwise pinch or kick back – **risk of injury.**

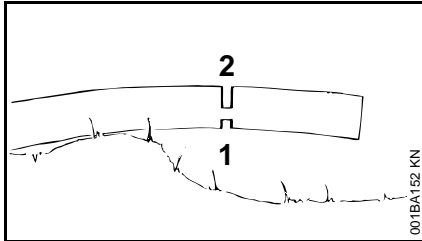
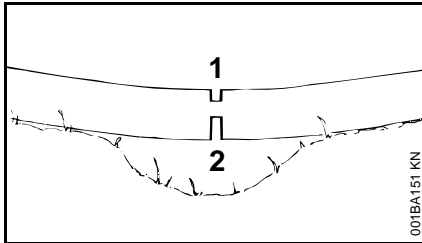

- Make relieving cut at the compression side (1)
- Make bucking cut at the tension side (2)

Be wary of **pushback** when making bucking cut from the bottom upwards (underbuck).



#### NOTICE

Do not cut a lying log at a point where it is touching the ground because the saw chain will otherwise be damaged.

#### Ripping cut:

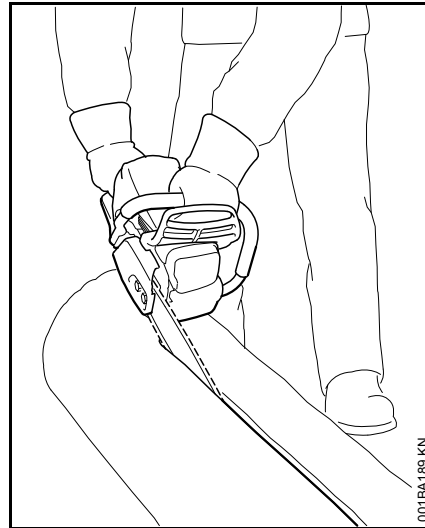

Cutting technique in which the spiked bumper is not used – risk of pull-in – start the cut with the guide bar at the shallowest possible angle – take extra care since there is an increased **danger of kickback**.

#### Preparing for felling

Check that there are no other persons in the felling area – other than helpers.

Make sure no-one is endangered by the falling tree – the noise of your engine may drown any warning calls.

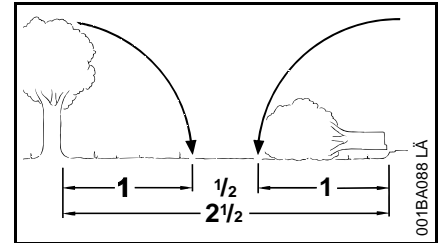

Maintain a distance of at least 2 1/2 tree lengths from the next felling site.

#### Determining direction of fall and escape path

Select gap in stand into which you want the tree to fall.

Pay special attention to the following points:

- The natural inclination of the tree
- Unusually heavy limb structure, asymmetrical growth, damage to tree
- The wind direction and speed – do not fell in high winds
- Direction of slope
- Neighboring trees
- Snow load
- Take the general condition of the tree into account – be especially careful with trunk damage or deadwood (brittle, rotten or dead wood)

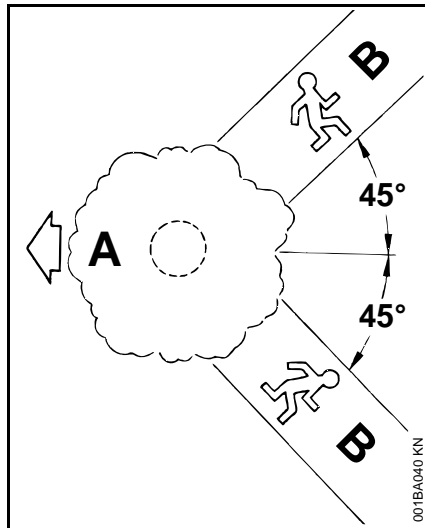

- A** Direction of fall
- B** Escape path (escape routes)
- Establish escape paths for each worker – approx. 45° diagonally opposite to the direction of fall
  - Clear escape paths, eliminate obstacles
  - Put down tools and equipment at a safe distance – but not on the escape paths
  - When felling, stand only to the side of the falling trunk and only move back laterally onto the escape path
  - Plan escape paths on slopes parallel to the slope
  - When walking away along the escape path, watch out for falling limbs and watch the top of the tree.

### Preparing work area at base of tree

- First clear the tree base and work area from interfering limbs and brush to provide a secure footing.
- Carefully clear the base of the trunk (e.g., with an axe) – sand, stones and other foreign objects will blunt the saw chain

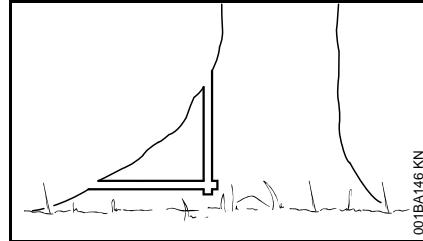

- Remove largest buttresses: first the largest buttress – saw first vertically, then horizontally – only if the tree is in sound condition

### Felling notch

#### Preparing the felling notch

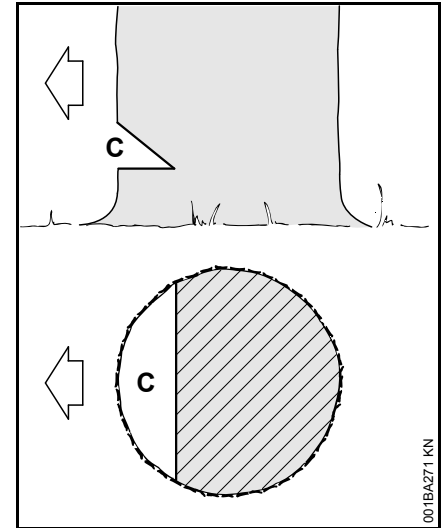

The felling notch (C) determines the direction of fall.

Important:

- Make a felling notch at right angle to direction of fall
- Saw as close to the ground as possible
- Cut to a depth of approx. 1/5 to 1/3 of the diameter of the trunk

### Determine direction of fall with gunning sight on cover and fan housing

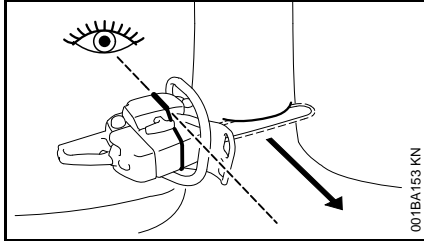

Your chainsaw has a gunning sight on the cover and fan housing. Use this gunning sight.

### Making the felling notch

When making a felling notch, align the chainsaw so that the notch lies at a right angle to the direction of fall.

During the procedure, various sequences are permitted for making a felling notch with a bottom (horizontal) cut and top (angled) cut – comply with national legislation regarding felling technique.

- Make a bottom (horizontal) cut
- Make the top (angled) cut approx. 45°- 60° to the bottom cut

### Checking the direction of fall

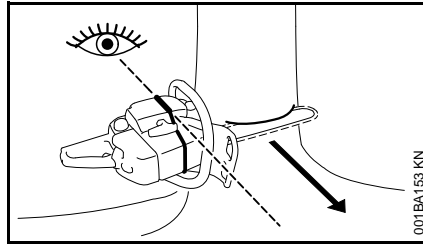

- Insert the chainsaw with guide bar in the bottom of the felling notch. The gunning sight must point in the planned direction of fall – if necessary, correct direction of fall by re-cutting the felling notch.

### Sapwood cuts

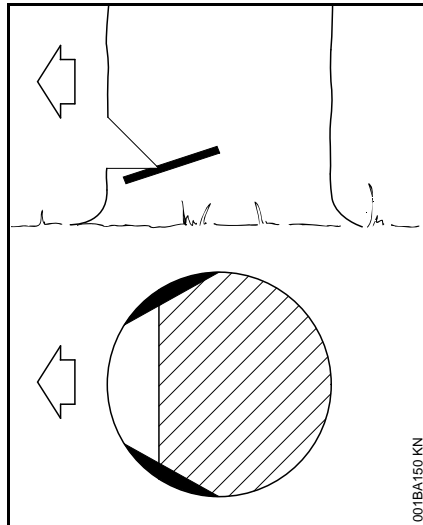

Sapwood cuts in long-fibered softwood help prevent sapwood splintering when the tree falls. Make cuts at both sides of the trunk at same height as bottom of

felling notch to a depth of about 1/10 of trunk diameter. On large diameter trees, cut to no more than width of guide bar.

Do not make sapwood cuts if wood is diseased.

### Basic information on felling cut

#### Basic dimensions

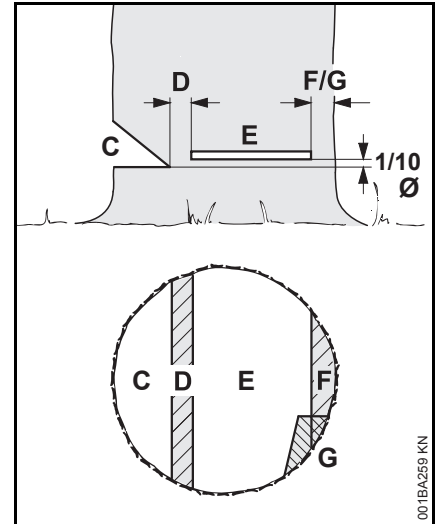

The **felling notch** (C) determines the direction of fall.

The **hinge** (D) functions like a real hinge to guide the tree to the ground.

- Width of hinge: approx. 1/10 of the trunk diameter
- Never saw through the hinge while felling – otherwise the tree will fall in a direction other than the one planned – **risk of accident!**
- With rotten trunks, leave a wider hinge

The tree is felled with the **felling cut** (E).

- Cut horizontally
- 1/10 (at least 3 cm) of tree diameter higher than bottom of felling notch (C).

The **holding strap** (F) or **stabilizing strap** (G) supports the tree and helps prevent it from falling prematurely.

- Width of strip: approx. 1/10 to 1/5 of the trunk diameter
- Do not cut into the strip during the felling cut
- With rotten trunks, leave a wider strip

### Plunge cutting

- For relieving cuts during shortening
- For wood carving

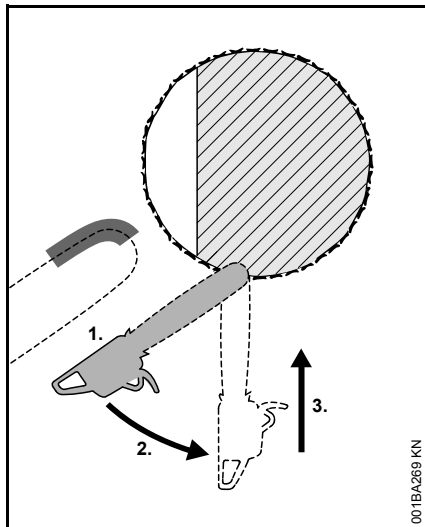

- Use a low kickback saw chain and proceed with special care

1. Begin cut by applying the lower portion of the guide bar nose – do not use upper portion because of **risk of kickback**. Cut at full strength until the depth of the kerf is twice the width of the guide bar
2. Swing the machine slowly into the plunge cutting position – **risk of kickback and pushback!**
3. Make the plunge cut very carefully. **Risk of pushback.**

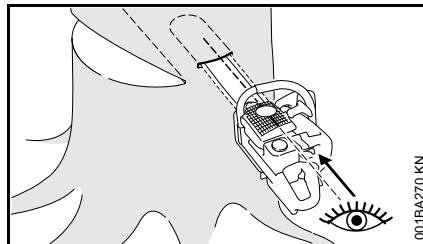

Where possible, use a plunge blade. The plunge blade and the upper/lower side of the guide bar are parallel.

During plunge cutting, the plunge bar helps to keep the hinge parallel in form, i.e. the same thickness at all points. To do this, guide the plunge bar parallel to the sink chord.

### Felling wedges

Insert the felling wedge as soon as possible, i.e. as soon as no obstruction of saw control is to be expected. Position the felling wedge in the felling cut and drive in with suitable tools.

Only use aluminum or plastic wedges – do not use steel wedges. Steel wedges can seriously damage the saw chain and cause dangerous kickback.

Select suitable felling wedges dependent on the trunk diameter and the width of the kerf (analogue to felling cut (E)).

Contact the STIHL dealer for the selection of the felling wedge (suitable length, width and height).

### Selecting the appropriate felling cut

The selection of the appropriate felling cut is dependent on the same tree characteristics that must be noted when determining the direction of fall and the escape paths.

There are various different features of these characteristics. This User Manual will only describe the two most commonly occurring variants:

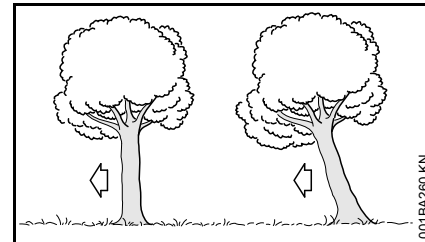

|        |  |
|--------|--|
| left:  | Normal tree – vertically upright tree with uniform crown |
| right: | Leaner tree - crown pointing in direction of fall        |



## Felling cut with stabilizing strap (normal tree)

### A) Thin trunks

Implement this felling cut when the trunk diameter is smaller than the cutting length of the chainsaw.

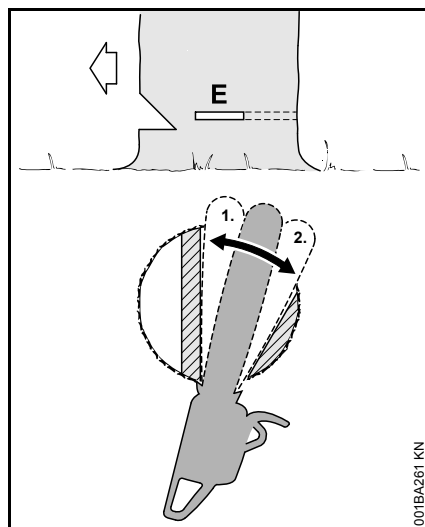

Shout a warning before starting the felling cut.

- Plunge cut the felling cut (E) – plunge the guide bar fully in
- Engage the spiked bumper behind the hinge and use this as the rotation point – reposition the chainsaw as little as possible
- Make the felling cut up to the hinge (1)
- Do not cut into the hinge
- Make the felling cut up to the stabilizing strap (2)

- Do not cut into the stabilizing strap

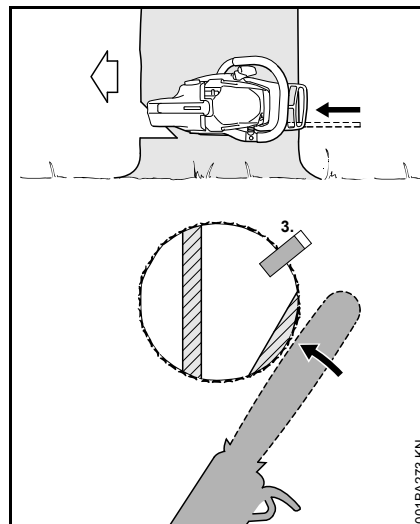

- Set the felling wedge (3)

Shout a second warning immediately before the tree falls.

- Cut through the stabilizing strap, horizontal level with the felling cut, with arms fully extended

### B) Thick trunks

Implement this felling cut when the trunk diameter is greater than the cutting length of the machine.

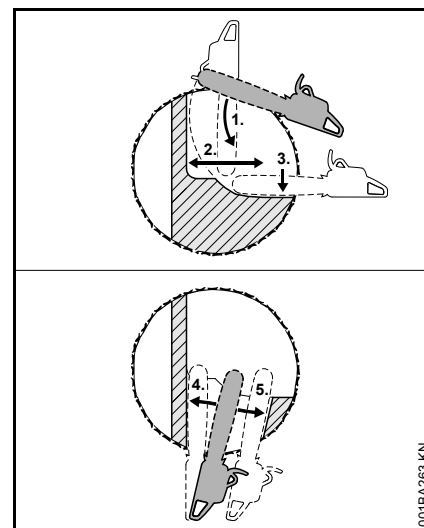

Shout a warning before starting the felling cut.

- Engage the spiked bumper at the height of the felling cut and use this as the rotation point – reposition the chainsaw as little as possible
- Tip of the guide bar must penetrate the wood before the hinge (1) – guide the chainsaw absolutely horizontally and swivel as widely as possible
- Make the felling cut up to the hinge (2)
- Do not cut into the hinge
- Make the felling cut up to the stabilizing strap (3)
- Do not cut into the stabilizing strap

The felling cut must be continued on the opposite side of the trunk.

Ensure that the second cut is at the same level as the first cut.

## English

- Plunge cut the felling cut
- Make the felling cut up to the hinge (4)
- Do not cut into the hinge
- Make the felling cut up to the stabilizing strap (5)
- Do not cut into the stabilizing strap

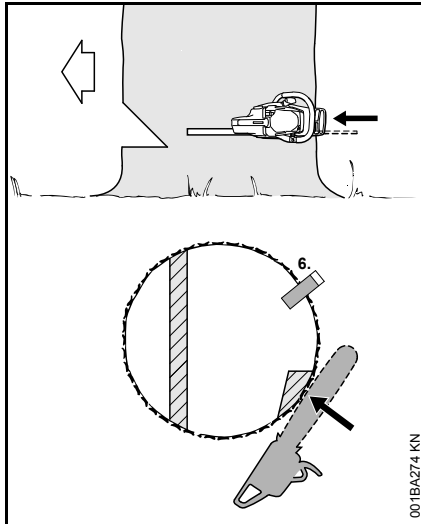

- Set the felling wedge (6)
- Shout a second warning immediately before the tree falls.
- Cut through the stabilizing strap, horizontal level with the felling cut, with arms fully extended

### Felling Cut with Holding Strap (Leaner)

#### A) Thin trunks

Implement this felling cut when the trunk diameter is smaller than the cutting length of the chainsaw.

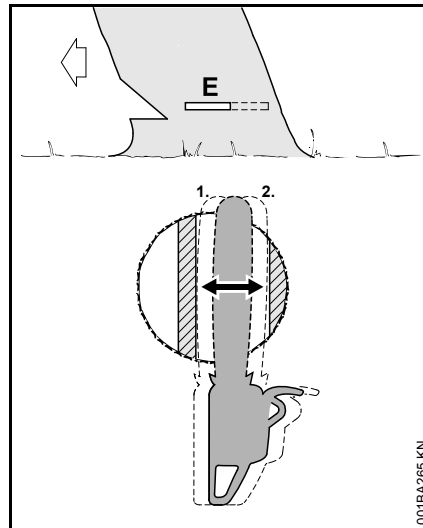

- Plunge cut the guide bar into the trunk until it exits on the other side
- Make the felling cut (E) towards the hinge (1)
- Cut horizontally
- Do not cut into the hinge
- Make the felling cut towards the holding strap (2)
- Cut horizontally
- Do not cut into the holding strap.

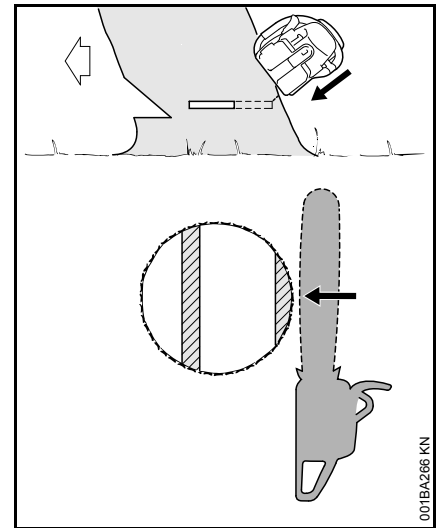

- Shout a second warning immediately before the tree falls.
- With outstretched arms, cut through the holding strap at a downward angle from outside.

## B) Thick trunks

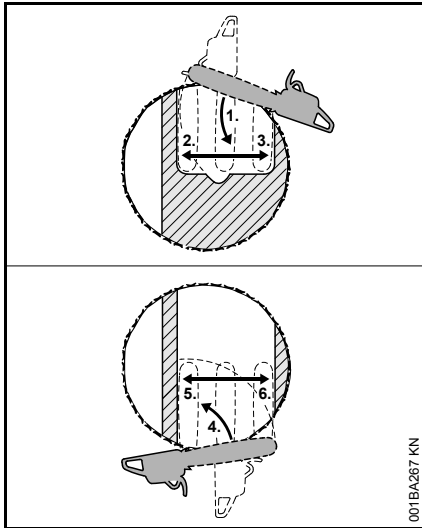

Perform this felling cut when the tree diameter is greater than the cutting length of the chainsaw.

- Engage the spiked bumper behind the holding strap and use it as a pivot – avoid repositioning the chainsaw more than necessary.
- The guide bar nose enters the wood (1) before it reaches the hinge – hold the chainsaw horizontally and swing it as far as possible.
- Do not cut into the holding strap or hinge.
- Make the felling cut up to the hinge (2)
- Do not cut into the hinge
- Make the felling cut up to the holding strap (3)
- Do not cut into the holding strap.

The felling cut must be continued on the opposite side of the trunk.

Ensure that the second cut is at the same level as the first cut.

- Engage the spiked bumper behind the hinge and use this as the rotation point – reposition the chainsaw as little as possible
- Tip of the guide bar must penetrate the wood before the holding strap (4) – guide the chainsaw absolutely horizontally and swivel as widely as possible
- Make the felling cut up to the hinge (5)
- Do not cut into the hinge
- Make the felling cut up to the holding strap (6)
- Do not cut into the holding strap.

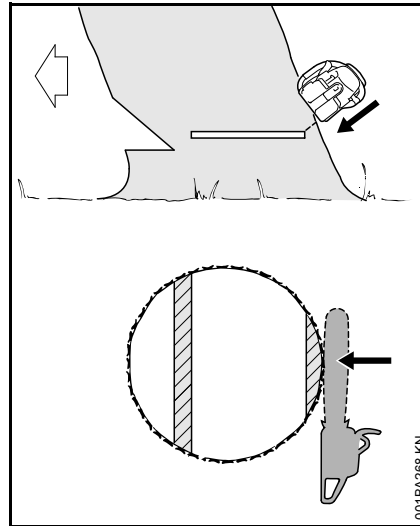

Shout a second warning immediately before the tree falls.

- With outstretched arms, cut through the holding strap at a downward angle from outside.

## Cutting Attachment

A cutting attachment consists of the saw chain, guide bar and chain sprocket.

The cutting attachment that comes standard is designed to exactly match the chain saw.

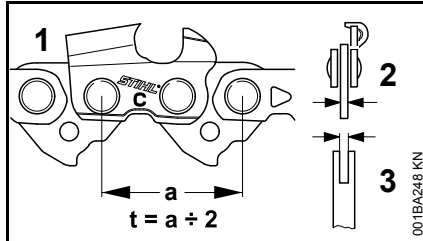

- The pitch (t) of the saw chain (1), chain sprocket and the nose sprocket of the Rollomatic guide bar must match.
- The drive link gauge (2) of the saw chain (1) must match the groove width of the guide bar (3).

If non-matching components are used, the cutting attachment may be damaged beyond repair after a short period of operation.

## Chain Scabbard

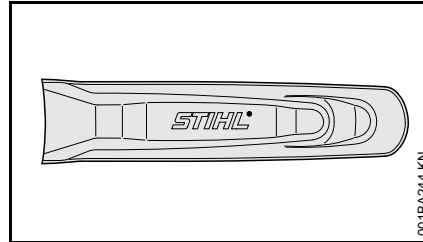

Your saw comes standard with a chain scabbard that matches the cutting attachment.

If guide bars of different lengths are mounted to the saw, always use a chain scabbard of the correct length which covers the complete guide bar.

The length of the matching guide bars is marked on the side of the chain scabbard.

## Mounting the Bar and Chain (side chain tensioner)

### Removing the chain sprocket cover

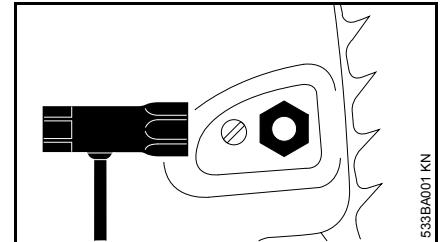

- Unscrew the nut and remove the chain sprocket cover.

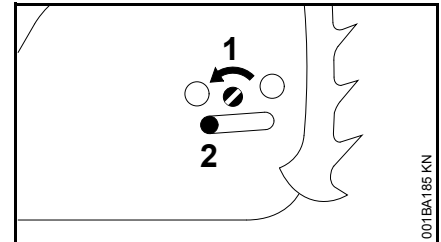

- Turn the screw (1) counterclockwise until the tensioner side (2) butts against the left end of the housing slot.

### Disengage the chain brake.

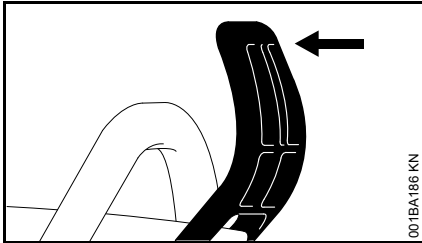

- Pull the hand guard towards the front handle until there is an audible click – the chain brake is disengaged.

### Fitting the chain

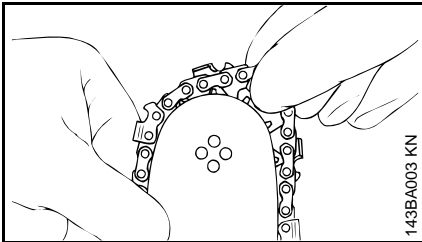

### **!** WARNING

Wear work gloves to protect your hands from the sharp cutters.

- Fit the chain – start at the bar nose.

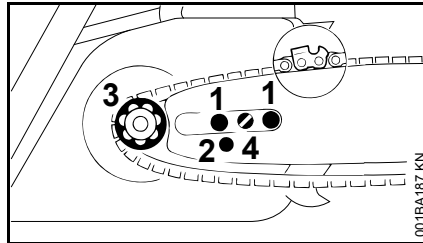

- Fit the guide bar over the studs (1) – the cutting edges on the top of the bar must point to the right.
- Engage the peg of the tensioner slide in the locating hole (2) – place the chain over the sprocket (3) at the same time.
- Turn the tensioning screw (4) clockwise until there is very little chain sag on the underside of the bar – and the drive link tangs are engaged in the bar groove.
- Refit the sprocket cover and screw on the nut only fingertight.
- Go to chapter on "Tensioning the Saw Chain"

### Mounting the Bar and Chain (quick chain tensioner)

#### Removing the chain sprocket cover

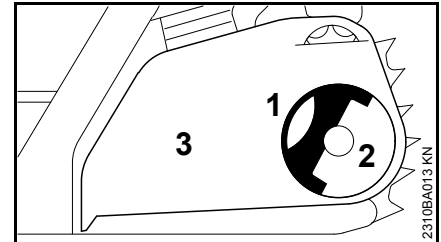

- Swing grip (1) into position (until it engages)
- Turn the wing nut (2) to the left until it hangs loosely in the chain sprocket cover (3)
- Remove chain sprocket cover (3)

#### Mounting the tensioning gear

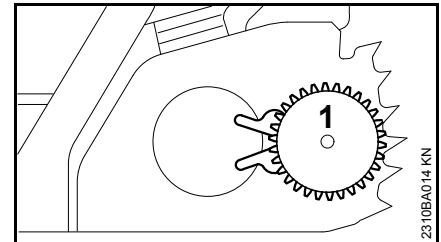

- Remove and reverse tensioning gear (1)

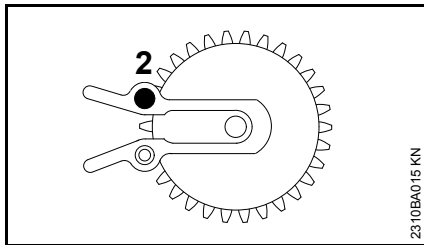

- Remove screw (2)

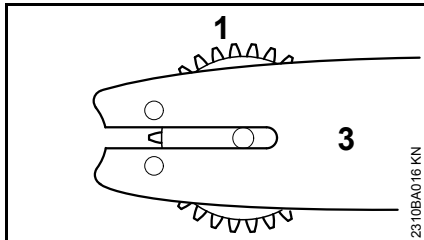

- Position tensioning gear (1) and guide bar (3) relative to one another

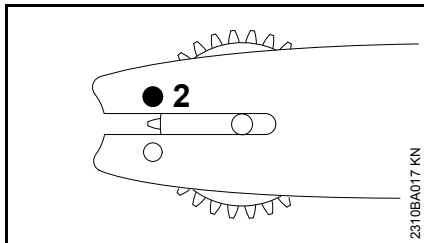

- Insert and tighten screw (2)

### Releasing the chain brake

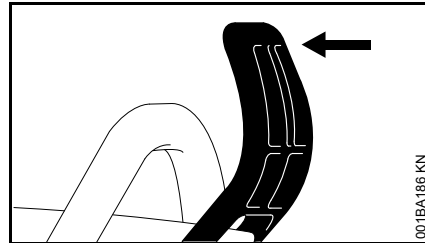

- Pull hand guard towards the front handle until it engages audibly – chain brake is released

### Fitting the saw chain

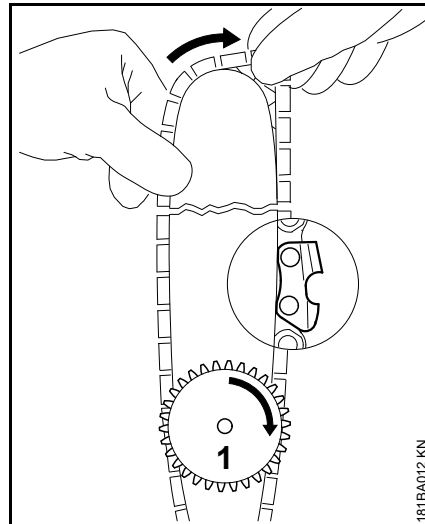

- Fit the saw chain – starting at the nose of the guide bar – pay attention to the position of the tensioning gear and the cutting edges
- Turn tensioning gear (1) to the right as far as possible
- Turn the guide bar so that the tensioning gear faces the user

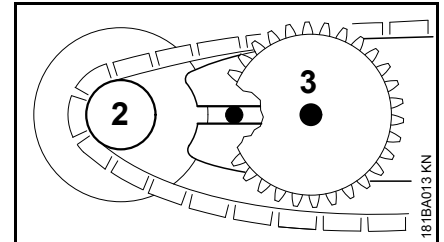

- Place the saw chain on the chain sprocket (2)
- Slide the guide bar over the collar screw (3); the head of the rear collar screw must protrude into the oblong hole

### WARNING

Put on protective gloves – risk of injury by the sharp cutters.

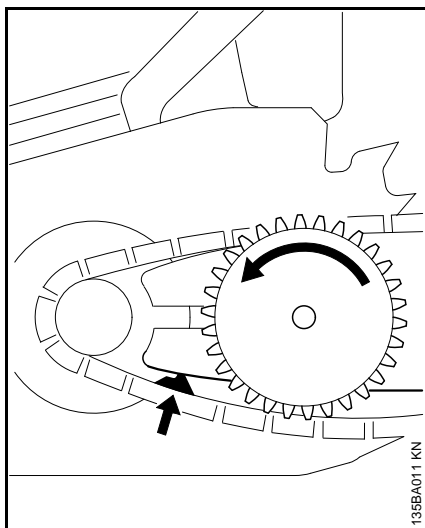

- Guide the drive link into the bar groove (see arrow) and turn the tensioning gear to the left as far as possible
- Fit chain sprocket cover, sliding the guide lugs into the engine housing openings

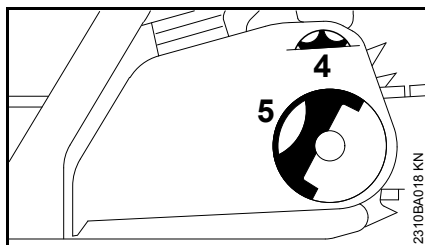

When fitting the chain sprocket cover, the teeth of the adjusting wheel and the tensioning gear must mesh; if necessary,

- turn the adjusting wheel (4) a little until the chain sprocket cover can be slid completely against the engine housing
- Swing grip (5) into position (until it engages)
- Fit wing nut and tighten lightly
- Next step: see "Tensioning the Saw Chain"

## Tensioning the Saw Chain (side chain tensioner)

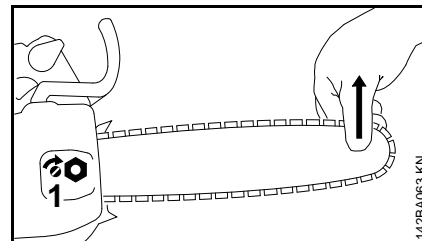

Retensioning during cutting work:

- Switch off the engine.
- Loosen the nut.
- Hold the bar nose up.
- Use a screwdriver to turn the tensioning screw (1) clockwise until the chain fits snugly against the underside of the bar.
- While still holding the bar nose up, tighten down the nut firmly.
- Go to "Checking Chain Tension".

A new chain has to be retensioned more often than one that has been in use for some time.

- Check chain tension frequently – see chapter on "Operating Instructions".

## Tensioning the Saw Chain (quick chain tensioner)

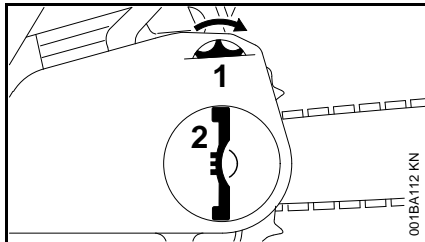

Retensioning during cutting work:

- Shut off the engine.
- Pull out the hinged clip and loosen the wingnut.
- Turn the adjusting wheel (1) clockwise as far as stop.
- Tighten down the wingnut (2) firmly by hand.
- Fold down the hinged clip.
- Go to "Checking Chain Tension"

A new chain has to be retensioned more often than one that has been in use for some time.

- Check chain tension frequently – see chapter on "Operating Instructions".

## Checking Chain Tension

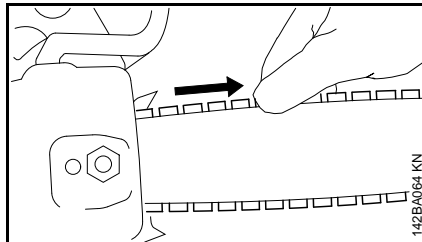

- Shut off the engine.
- Wear work gloves to protect your hands.
- The chain must fit snugly against the underside of the bar and it must still be possible to pull the chain along the bar by hand when the chain brake is released.
- If necessary, retension the chain.

A new chain has to be retensioned more often than one that has been in use for some time.

- Check chain tension frequently – see chapter on "Operating Instructions".

## Fuel

Your engine requires a mixture of gasoline and engine oil.

### **WARNING**

For health reasons, avoid direct skin contact with gasoline and avoid inhaling gasoline vapor.

### **STIHL MotoMix**

STIHL recommends the use of STIHL MotoMix. This ready-to-use fuel mix contains no benzol or lead, has a high octane rating and ensures that you always use the right mix ratio.

STIHL MotoMix uses STIHL HP Ultra two-stroke engine oil for an extra long engine life.

MotoMix is not available in all markets.

### **Mixing Fuel**

### **NOTICE**

Unsuitable fuels or lubricants or mix ratios other than those specified may result in serious damage to the engine. Poor quality gasoline or engine oil may damage the engine, sealing rings, hoses and the fuel tank.

### **Gasoline**

Use only high-quality **brand-name** gasoline with a minimum octane rating of 90 – leaded or unleaded.



Gasoline with an ethanol content of more than 10% can cause running problems in engines with a manually adjustable carburetor and should not be used in such engines.

Engines equipped with M-Tronic deliver full power when run on gasoline with an ethanol content of up to 25% (E25).

### Engine Oil

If you mix the fuel yourself, use only STIHL two-stroke engine oil or another high-performance engine oil in accordance with JASO FB, JASO FC, JASO FD, ISO-L-EGB, ISO-L-EGC or ISO-L-EGD.

STIHL specifies STIHL HP Ultra two-stroke engine oil or an equivalent high-performance engine oil in order to maintain emission limits over the machine's service life.

### Mix Ratio

STIHL 50:1 two-stroke engine oil: 50 parts gasoline to 1 part oil

### Examples

| Gasoline<br>Liters | STIHL engine oil 50:1<br>Liters (ml) |       |
|--------------------|--------------------------------------|-------|
| 1                  | 0.02                                 | (20)  |
| 5                  | 0.10                                 | (100) |
| 10                 | 0.20                                 | (200) |
| 15                 | 0.30                                 | (300) |
| 20                 | 0.40                                 | (400) |
| 25                 | 0.50                                 | (500) |

- Use a canister approved for storing fuel. Pour oil into canister first, then add gasoline and mix thoroughly.

### Storing Fuel

Store fuel only in approved safety-type fuel canisters in a dry, cool and safe location protected from light and the sun.

**Fuel mix ages** – only mix sufficient fuel for a few weeks work. Do not store fuel mix for longer than 30 days. Exposure to light, the sun, low or high temperatures can quickly make the fuel mix unusable.

STIHL MotoMix may be stored for up to 2 years without any problems.

- Thoroughly shake the mixture in the canister before fueling your machine.

### WARNING

Pressure may build up in the canister – open it carefully.

- Clean the fuel tank and canister from time to time.

Dispose of remaining fuel and cleaning fluid properly in accordance with local regulations and environmental requirements.

## Fueling



### Preparing the machine

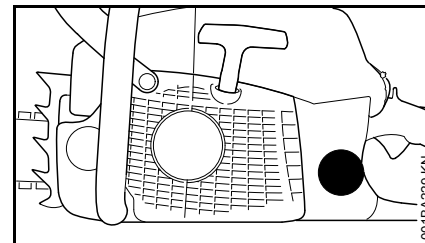

- Before fueling, clean the cap and the area around it to ensure that no dirt falls into the fuel tank
- Always position the machine so that the cap is facing upwards

### Opening

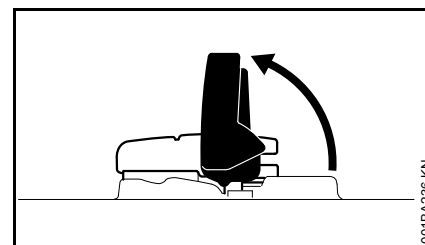

- Raise grip to vertical position.

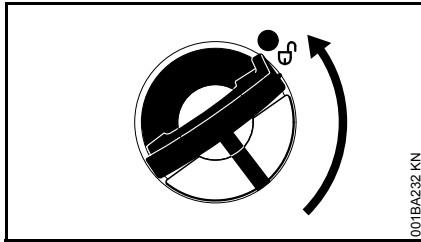

- Turn the cap counterclockwise (about a quarter turn).

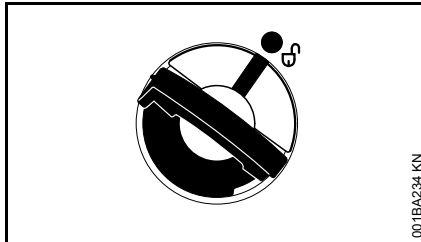

Marks on tank cap and fuel tank must line up.

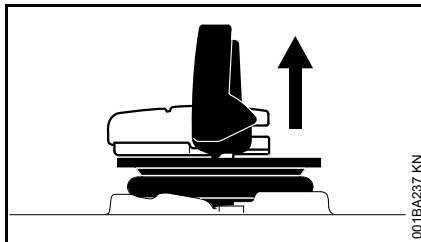

- Remove the tank cap.

### Filling Up with Fuel

Take care not to spill fuel while fueling and do not overfill the tank.

STIHL recommends you use the STIHL filler nozzle for fuel (special accessory).

- Fill the fuel tank.

### Closing

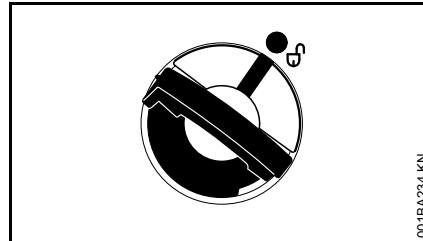

Grip must be vertical:

- Fit the cap – marks on tank cap and fuel tank must line up.
- Press the cap down as far as stop.

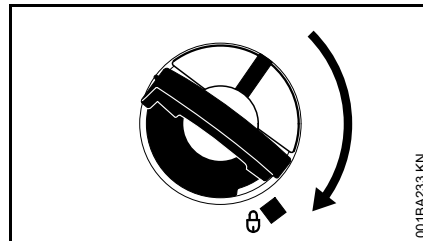

- While holding the cap depressed, turn it clockwise until it engages in position.

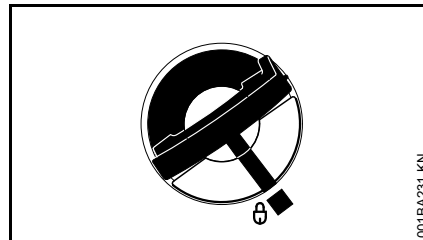

The marks on the tank cap and fuel tank are then in alignment.

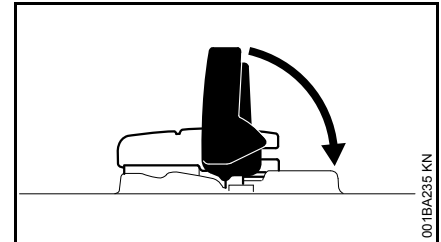

- Fold the grip down.

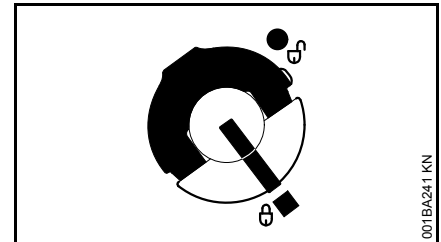

Tank cap is locked.

### If the tank cap cannot be locked in the fuel tank opening

Bottom of cap is twisted in relation to top.

- Remove the cap from the fuel tank and check it from above.

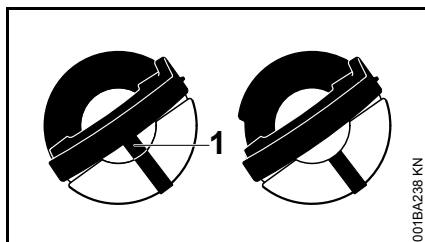

- Left: Bottom of cap is twisted – inner mark (1) in line with outer mark.
- Right: Bottom of cap in correct position – inner mark is under the grip. It is not in line with the outer mark.

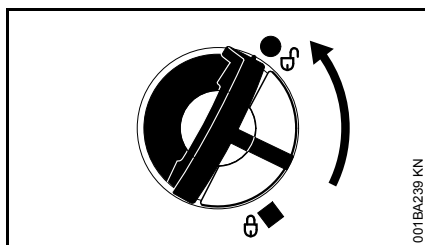

- Place the cap on the opening and rotate it counterclockwise until it engages the filler neck.
- Continue rotating the cap counterclockwise (about a quarter turn) – this causes the bottom of the cap to be turned to the correct position.
- Turn the cap clockwise and lock it in position – see section on "Closing".

## Chain Lubricant

For automatic and reliable lubrication of the chain and guide bar – use only an environmentally compatible quality chain and bar lubricant. Rapidly biodegradable STIHL BioPlus is recommended.



### NOTICE

Biological chain oil must be resistant to aging (e.g. STIHL BioPlus), since it will otherwise quickly turn to resin. This results in hard deposits that are difficult to remove, especially in the area of the chain drive and chain. It may even cause the oil pump to seize.

The service life of the chain and guide bar depends on the quality of the lubricant. It is therefore essential to use only a specially formulated chain lubricant.



### WARNING

Do not use waste oil. Renewed contact with waste oil can cause skin cancer. Moreover, waste oil is environmentally harmful.



### NOTICE

Waste oil does not have the necessary lubricating properties and is unsuitable for chain lubrication.

## Filling Chain Oil Tank



### Preparations

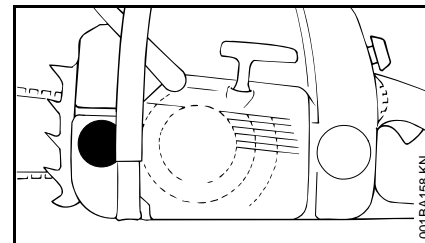

- Thoroughly clean the oil filler cap and the area around it to ensure that no dirt falls into the tank.
- Position the machine so that the filler cap is facing up.
- Open the filler cap.

### Fill up with chain oil.

- Refill the chain oil tank every time you refuel.

Take care not to spill chain oil while refilling and do not overfill the tank.

STIHL recommends you use the STIHL filler nozzle for chain oil (special accessory).

- Close the filler cap.

There must still be a small amount of oil in the oil tank when the fuel tank is empty.

If the oil level in the tank does not go down, the reason may be a fault in the oil supply system: Check chain lubrication, clean the oilways, contact your dealer for assistance if necessary. STIHL recommends that you have servicing and repair work carried out exclusively by an authorized STIHL servicing dealer.

## Checking Chain Lubrication

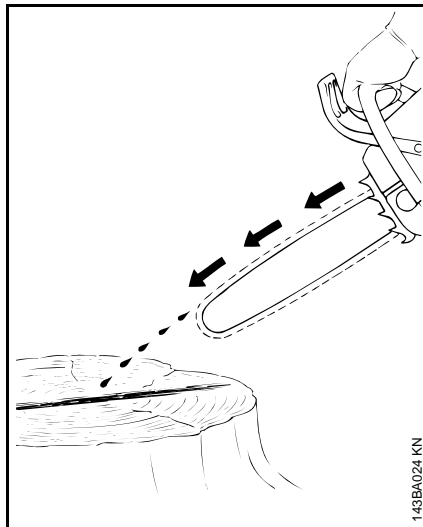

The saw chain must always throw off a small amount of oil.

### NOTICE

Never operate your saw without chain lubrication. If the chain runs dry, the whole cutting attachment will be irretrievably damaged within a very short time. Always check chain lubrication and the oil level in the tank before starting work.

Every new chain has to be broken in for about 2 to 3 minutes.

After breaking in the chain, check chain tension and adjust if necessary – see "Checking Chain Tension".

## Chain Brake



### Locking the chain

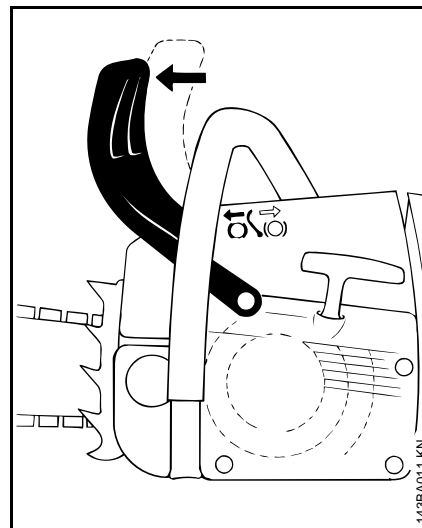

- in an emergency
- when starting
- at idling speed

The chain brake is activated by pushing the hand guard toward the bar nose with your left hand – or by inertia in certain kickback situations: The chain is stopped and locked.

## Releasing the chain brake

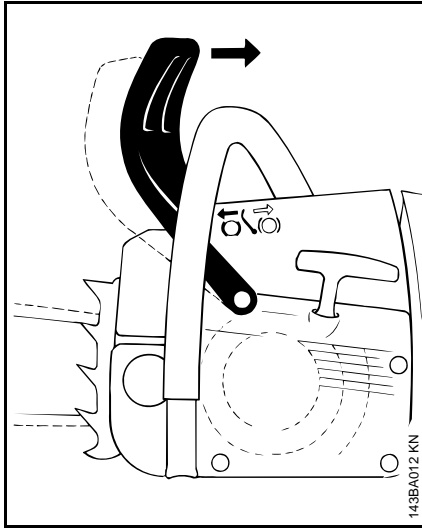

- Pull the hand guard back toward the front handle,

### NOTICE

Always disengage chain brake before accelerating the engine (except when checking its operation) and before starting cutting work.

High revs with the chain brake engaged (chain locked) will quickly damage the powerhead and chain drive (clutch, chain brake).

The chain brake is also activated by the inertia of the front hand guard if the kickback force of the saw is high enough: The hand guard is accelerated toward the bar nose – even if your left hand is not behind the hand guard, e.g. during felling cut.

The chain brake will operate only if the hand guard has not been modified in any way.

## Check operation of the chain brake

Before starting work: Run engine at idle speed, engage the chain brake (push hand guard toward bar nose) and open the throttle wide for no more than 3 seconds – the chain must not rotate. The hand guard must be free from dirt and move freely.

## Chain brake maintenance

The chain brake is subject to normal wear. It is necessary to have it serviced and maintained regularly by trained personnel. STIHL recommends that you have servicing and repair work carried out exclusively by an authorized STIHL servicing dealer. Maintain the following servicing intervals:

|                   |                 |
|-------------------|-----------------|
| Full-time usage:  | every 3 months  |
| Part-time usage:  | every 6 months  |
| Occasional usage: | every 12 months |

## Winter Operation



### Pre-heating carburetor

- Remove the shroud – see "Shroud"

### At temperatures below +10 °C

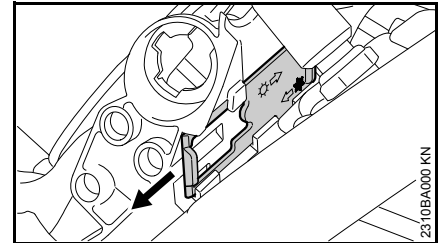

- Using a screwdriver, pry the shutter out of the ☀ (summer operation) position

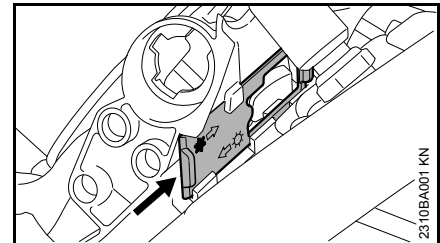

- Place the shutter with the opening in the direction of the chain saw in the ❄ position (winter operation) – shutter must audibly snap into place
- Fit the shroud – see "Shroud"

Heated air is now drawn in from around the cylinder and circulates around the carburetor – this helps prevent carburetor icing.

#### At temperatures above +20 °C

- Ensure that the shutter is always returned to position ☀ (summer operation), otherwise the engine may malfunction due to overheating

#### At temperatures below -10 °C

- if the chain saw is extremely cold (frost formation) – after starting, bring the engine up to operating temperature at increased idle speed (disengage chain brake!)

In case of erratic idling behavior or poor acceleration

- Turn the low speed screw (L) 1/4 turn counterclockwise

Whenever the low speed screw (L) has been adjusted, it is usually also necessary to adjust the idle speed adjusting screw (LA), see "Setting the carburetor".

#### Air filter system

- Retrofit new air filter if necessary – see "Air filter system"

## Starting / Stopping the Engine

### Positions of Master Control Lever

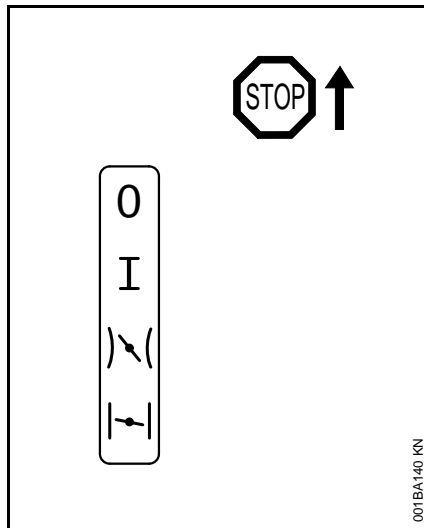

**Stop 0** – engine off – the ignition is switched off

**Normal run position I** – engine runs or can fire.

**Starting throttle** |↘| – this position is used to start a warm engine. The Master Control lever moves to the normal run position as soon as the throttle trigger is squeezed.

**Choke shutter closed** |↖| – this position is used to start a cold engine.

### Setting the Master Control Lever

To move the Master Control lever from the normal run position (I) to choke closed (|↖|), press down the throttle trigger lockout and squeeze the throttle trigger at the same time and hold them in that position – now set the Master Control lever.

To select the starting throttle position (|↘|), move the Master Control lever to choke closed (|↖|) first, then push it into the starting throttle position (|↘|).

The Master Control lever must be in the choke closed position (|↖|) for the changeover to the starting throttle position (|↘|).

The Master Control lever moves from the starting throttle position (|↘|) to the run position (I) when you press down the throttle trigger lockout and blip the throttle trigger at the same time.

To switch off the engine, move the Master Control lever to Stop (0).

#### Choke shutter closed (|↖|)

- if the engine is cold
- if the engine stalls when you open the throttle after starting.
- if the fuel tank was run until empty (engine stopped).

#### Starting throttle position (|↘|)

- if the engine is warm, i.e. if it has been running for about one minute.
- When the engine begins to fire
- after clearing a flooded combustion chamber.

## Fuel pump

Press the manual fuel pump bulb several times – even if the bulb is already filled with fuel:

- When starting for the first time.
- if the fuel tank was run until empty (engine stopped).

## Holding the Saw

There are two ways of holding the saw when starting.

### On the ground

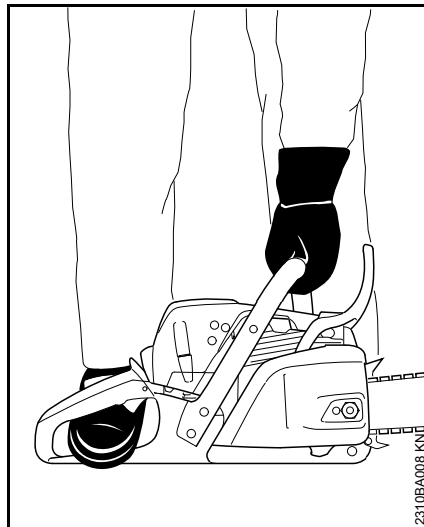

- Place your saw on the ground. Make sure you have a firm footing – check that the chain is not touching any object or the ground.
- Hold the saw firmly on the ground with your left hand on the front handle – your thumb should be under the handle.
- Put your right foot into the rear handle and press down.

### Between knees or thighs

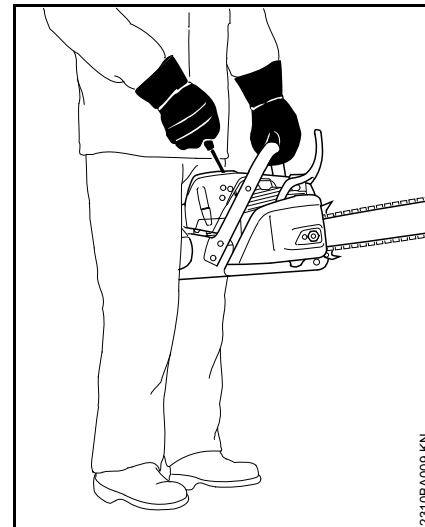

- Hold the rear handle tightly between your legs, just above the knees.
- Hold the front handle firmly with your left hand – your thumb should be under the handle.

## Cranking

### Standard versions

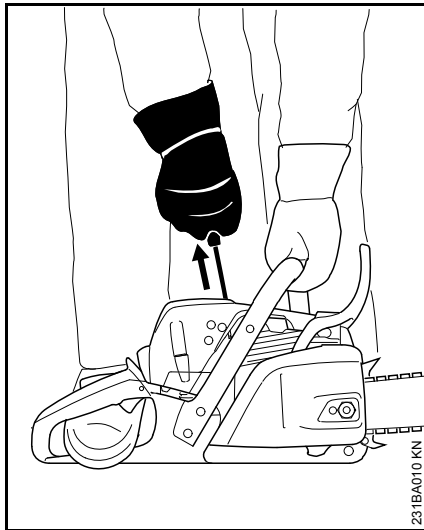

- Pull the starter grip slowly with your right hand until you feel it engage – and then give it a brisk strong pull and push down the front handle at the same time. Do not pull out the starter rope to full length – **it might otherwise break**. Do not let the starter grip snap back. Guide it slowly back into the housing so that the starter rope can rewind properly.

Machines without additional manual fuel pump: If the engine is new or after a long out-of-service period, it may be necessary to pull the starter rope several times to prime the fuel system.

### Versions with ErgoStart

#### WARNING

This machine is extremely simple and easy to start, even for children – **risk of accidents**.

Do not allow children or other unauthorized persons to attempt to start or otherwise use the machine:

- Never leave the machine unattended during work breaks.
- After work, store the machine in a safe, secure location.

The ErgoStart stores the energy required to start the saw. For this reason there may be a delay of a few seconds between cranking the engine and it actually starting.

There are two ways of starting with the ErgoStart:

- Hold the starter grip with your right hand and pull it out slowly and steadily – **or** – hold the starter grip with your right hand and give it several short pulls, using only a short length of rope for each pull.
- Push down the handle while cranking. Do not pull out the rope to its full length – **it might otherwise break**.
- Do not let the starter grip snap back. Guide it slowly back into the housing so that the starter rope can rewind properly.

## Starting the Saw

#### WARNING

Bystanders must be well clear of the general work area of the saw.

- Observe safety precautions.

### Versions with manual fuel pump

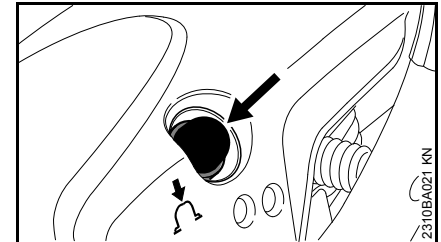

- Press the manual fuel pump bulb at least five times – even if the bulb is already filled with fuel.



## All models

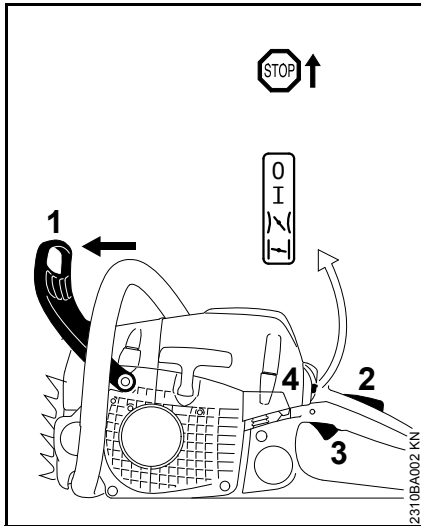

- Push the hand guard (1) forward – the chain is locked.
- Press down the trigger lockout (2) and pull the throttle trigger (3) at the same time. Set Master Control lever (4) to:

**Choke shutter closed (I↖)**

- if the engine is cold (also use this position if the engine stopped when you opened the throttle after starting)

**Starting throttle position (I↖)**

- if the engine is warm, i.e. if it has been running for about one minute.
- Hold and start your saw as described.

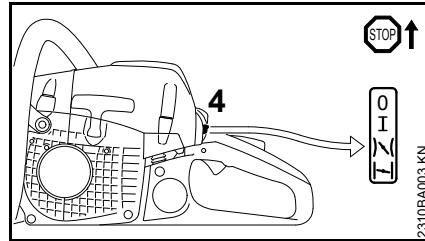
**When engine begins to fire**

- Set the Master Control lever (4) to the starting throttle position (I↖).
- Hold and start your saw as described.

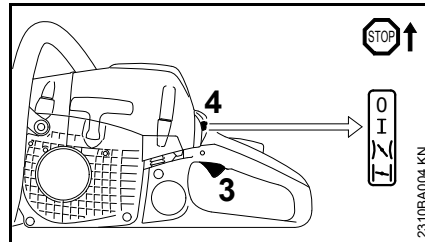
**As soon as the engine runs**

- Press down trigger lockout and the blip the throttle trigger (3) – the Master Control lever (4) moves to the run position (I) and the engine settles down to idling speed.



As the chain brake is still engaged, the engine must be returned to idling speed **immediately** – or the engine housing and chain brake might otherwise be damaged.

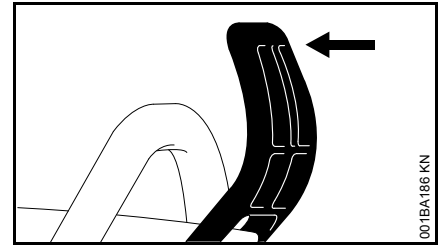

- Pull the hand guard back towards the front handle.

The chain brake is now disengaged – your saw is ready for operation.



Always disengage chain brake before accelerating the engine. High revs with the chain brake engaged (chain locked) will quickly damage the clutch and chain brake.

**At very low outside temperatures**

- Allow engine to warm up at part throttle.
- Change over to winter operation if necessary – see “Winter Operation”.

**Stopping the engine**

- Move the Master Control lever to the stop position (0).

**If the engine does not start**

If you did not move the Master Control lever from the choke closed position (I↖) to the starting throttle

position (↖) quickly enough after the engine began to fire, the combustion chamber may be flooded.

- Move the Master Control lever to the stop position (0).
- Remove the spark plug – see "Spark Plug".
- Dry the spark plug.
- Crank the engine several times with the starter to clear the combustion chamber.
- Refit the spark plug – see "Spark Plug".
- Set Master Control lever to the starting throttle position (↖) – even if the engine is cold.
- Now start the engine.

## Operating Instructions

### During the break-in period

A factory new machine should not be run at high revs (full throttle off load) for the first three tank fillings. This avoids unnecessarily high loads during the break-in period. As all moving parts have to bed in during the break-in period, the frictional resistances in the shortblock are greater during this period. The engine develops its maximum power after about 5 to 15 tank fillings.

### During work



#### NOTICE

Do not make the mixture leaner to achieve an apparent increase in power – this could damage the engine – see "Adjusting the Carburetor".



#### NOTICE

Open the throttle only when the chain brake is off. Running the engine at high revs with the chain brake engaged (chain locked) will quickly damage the shortblock and chain drive (clutch, chain brake).

### **Check chain tension frequently**

A new saw chain must be retensioned more frequently than one that has been in use already for an extended period.

### **Chain cold**

Tension is correct when the chain fits snugly against the underside of the bar but can still be pulled along the bar by hand. Retension if necessary – see "Tensioning the Saw Chain".

### **Chain at operating temperature**

The chain stretches and begins to sag. The drive links must not come out of the bar groove on the underside of the bar – the chain may otherwise jump off the bar. Retension the chain – see "Tensioning the Saw Chain".



#### NOTICE

The chain contracts as it cools down. If it is not slackened off, it can damage the crankshaft and bearings.

### **After a long period of full-throttle operation**

After a long period of full-throttle operation, allow engine to run for a while at idle speed so that the heat in the engine can be dissipated by flow of cooling air. This protects engine-mounted components (ignition, carburetor) from thermal overload.

### After finishing work

- Slacken off the chain if you have retensioned it at operating temperature during work.



Always slacken off the chain again after finishing work. The chain contracts as it cools down. If it is not slackened off, it can damage the crankshaft and bearings.

### Short-term storage

Wait for engine to cool down. Keep the machine with a full tank of fuel in a dry place, well away from sources of ignition, until you need it again.

### Long-term storage

See "Storing the machine"

## Taking Care of the Guide Bar

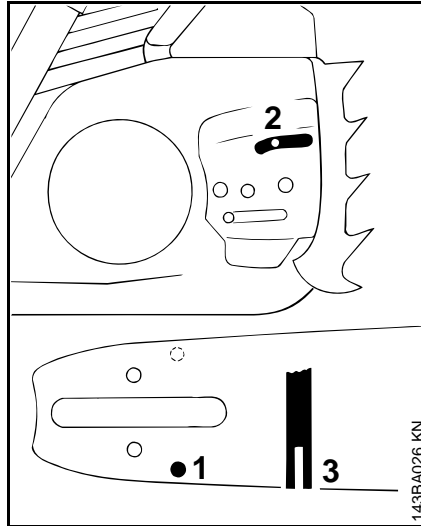

|       |              |        |
|-------|--------------|--------|
| Picco | 3/8" P       | 5.0 mm |
| Rapid | 3/8"; 0.325" | 6.0 mm |
| Rapid | 0.404"       | 7.0 mm |

If the groove is not at least this deep:

- Replace guide bar

Otherwise the drive links will grind against the base of the groove – the bottoms of the cutters and the tie straps will not lie against the bar.

- Flip the bar – after each sharpening and each time the chain is changed – to avoid uneven wear, especially at the sprocket nose and on the bottom
- Periodically clean the oil inlet hole (1), oil outlet channel (2) and bar groove (3)
- Measure groove depth – using the measuring tool on the file gauge (special accessory) – in the area with the greatest wear

| Chain type | Chain pitch | Minimum groove depth |
|------------|-------------|----------------------|
| Picco      | 1/4" P      | 4.0 mm               |
| Rapid      | 1/4"        | 4.0 mm               |

## Shroud

### Remove shroud

- Move the Master Control Lever to the stop position 0
- Push the front hand guard forwards – the saw chain is blocked

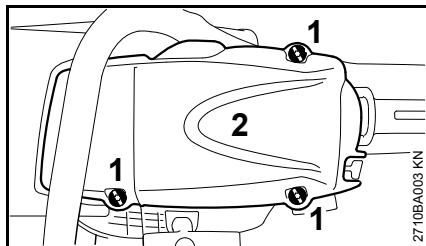

- Loosen screws (1)
- Remove the shroud (2)

### Refitting the shroud

- Refit the shroud and tighten the screws

## Air Filter System

The air filter system can be adapted to suit different operating conditions by installing different filters. Changing the filter is quick and simple.

### Fleece filter

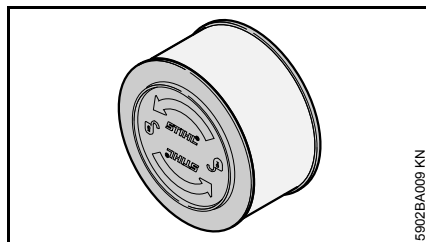

- Fleece filter for normal operating conditions and dry work areas.

### HD2 filter

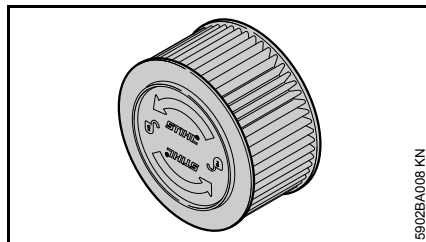

- HD2 filter (black filter frame, pleated filter material) for extreme wintry conditions (e.g. powder or drifting snow) or very dusty work areas.

## Cleaning the Air Filter

**If there is a noticeable loss of engine power.**

- Remove the shroud – see "Shroud".

### Removing the air filter

- Clean away loose dirt from around the filter.



### NOTICE

To avoid damaging the filter, do not use tools for removing and installing the air filter.

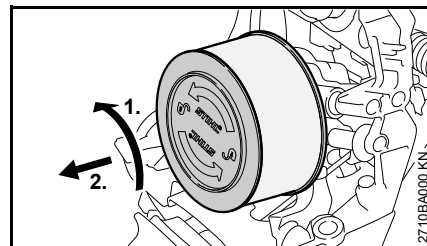

- Rotate the air filter a 1/4 turn counterclockwise and lift it away in the direction of the rear handle.
- Always replace a damaged filter.

### Cleaning the air filter (fleece filter)

- Knock out the filter or blow it clear with compressed air from the inside outwards.

If knocking it out or blowing it clear is not sufficient to remove stubborn dirt, or if the filter fabric is sticky, perform the following steps:

- Wash the filter in STIHL special cleaner (special accessory) or a clean, non-flammable solution (e.g. warm soapy water). Rinse the filter from the inside outwards under a jet of water – do not use a pressure washer.
- Dry the filter components – do not expose to high temperatures.

**NOTICE**

High temperatures and oil can damage the air filter. Filter efficiency can deteriorate as a result.

- Allow air filter to dry without using any external source of heat.
- Do not impregnate the filter with oil.
- Install the air filter.

**Cleaning the air filter (HD2 filter)**

- Knock out the filter.
- Spray outside of filter with STIHL special cleaner or soapy water.
- Rinse outside of filter under warm running water.

**NOTICE**

High temperatures and oil can damage the air filter. Filter efficiency can deteriorate as a result.

- Allow air filter to dry without using any external source of heat.
- Do not impregnate the filter with oil.
- Allow air filter to dry.
- Install the air filter.

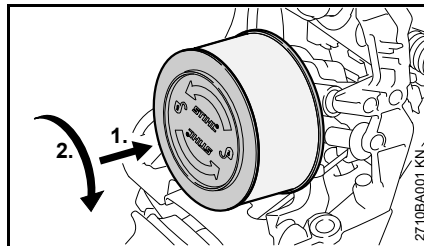
**Installing the air filter**

- Place the air filter in position.
- Push the air filter in the direction of the filter housing and turn it clockwise at the same time until it engages – the "STIHL" name must be horizontal.
- Install the shroud – see "Shroud".

**Adjusting the Carburetor****Basic information**

The carburetor comes from the factory with a standard setting.

The carburetor has been adjusted for optimum performance and fuel efficiency in all operating states.

**Standard setting**

- Switch off the engine
- Check the air filter – clean or replace it if necessary

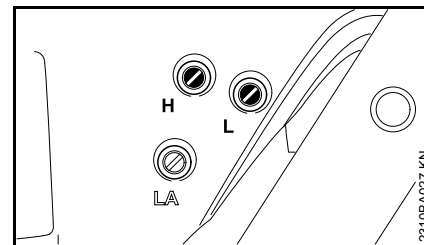

- Turn the high speed adjusting screw (H) counterclockwise as far as possible (max. 3/4 turn)
- Turn the low speed adjusting screw (L) clockwise until it is firmly in its seat – then back off 1/4 turn

**Setting the idle speed**

- Make standard setting
- Start engine and let it warm up

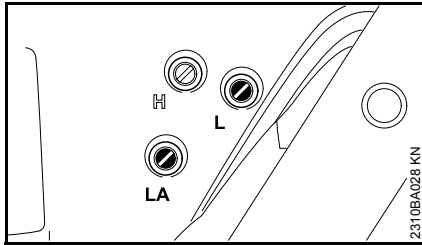

### Engine stops when idling

- Turn the idle speed adjusting screw (LA) clockwise until the saw chain begins to run – then turn it back 2 3/4 turn.

### Saw chain rotates at idle speed

- Turn the idle speed screw (LA) counterclockwise until the saw chain stops turning – then turn another 2 3/4 turns in the same direction

### WARNING

If the saw chain continues to keep rotating in idle even after adjustment, have the chain saw checked by a servicing dealer.

### Speed erratic when idling; poor acceleration (despite standard setting of low speed adjusting screw)

The idle setting is too lean.

- Carefully turn the low speed adjusting screw (L) counterclockwise until the engine runs smoothly and accelerates properly.

Whenever the low speed adjusting screw (L) has been adjusted, it is usually also necessary to readjust the idle speed adjusting screw (LA).

### Correcting the carburetor setting for use at high altitudes

The setting may have to be marginally corrected if engine performance is unsatisfactory at high altitudes:

- Make standard setting
- Let the engine warm up
- Turn the high speed adjusting screw (H) slightly clockwise (leaner) – max. up to the stop

### NOTICE

After descending from a high altitude, restore the carburetor setting to the standard setting.

If you make the setting too lean it will increase the risk of engine damage through lack of lubrication and overheating.

### Spark Arresting Screen in Muffler

- If engine performance deteriorates, check the spark arresting screen in the muffler
- Let the muffler cool down

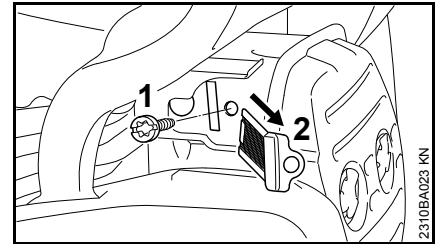

- Unscrew the screw (1)
- Pull out spark arresting screen (2)
- Clean the dirty spark arresting screen, replace if damaged or heavily carbonized
- Refit the spark arresting screen
- Fit screw

## Spark Plug

- If the engine is down on power, difficult to start or runs poorly at idle speed, first check the spark plug.
- Fit a new spark plug after about 100 operating hours – or sooner if the electrodes are badly eroded. Install only suppressed spark plugs of the type approved by STIHL – see "Specifications".

### Removing the spark plug

- Remove the shroud – see "Shroud"

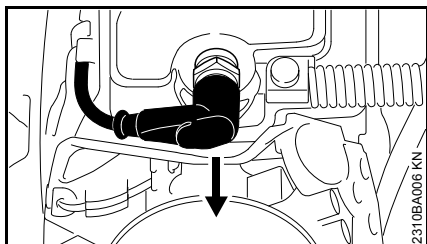

- Pull off the spark plug boot
- Unscrew spark plug

### Checking the Spark Plug

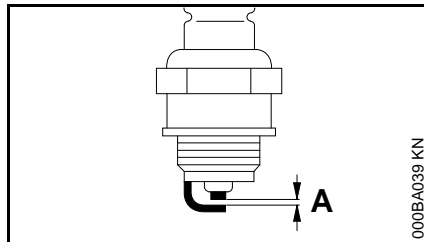

- Clean dirty spark plug.
- Check electrode gap (A) and readjust if necessary – see "Specifications".
- Rectify the problems which have caused fouling of the spark plug.

Possible causes are:

- Too much oil in fuel mix.
- Dirty air filter.
- Unfavorable running conditions.

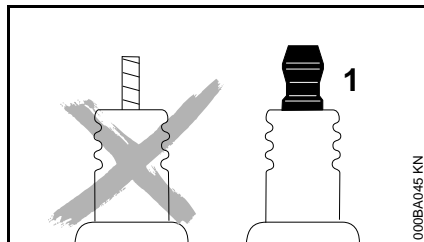

### **!** WARNING

Arcing may occur if the adapter nut (1) is loose or missing. Working in an easily combustible or explosive atmosphere may cause a fire or an explosion. This can result in serious injuries or damage to property.

- Use resistor type spark plugs with a properly tightened adapter nut.

### Installing the spark plug

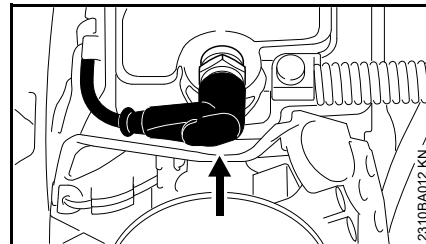

- Fit spark plug by hand
- Tighten the spark plug and press on the spark plug boot firmly
- Fit the shroud – see "Shroud"

## Storing the Machine

For periods of 3 months or longer

- Drain and clean the fuel tank in a well ventilated area.
- Dispose of fuel properly in accordance with local environmental requirements.
- Run the engine until the carburetor is dry – this helps prevent the carburetor diaphragms sticking together.
- Remove the saw chain and guide bar, clean them and spray with corrosion inhibiting oil.
- Thoroughly clean the machine – pay special attention to the cylinder fins and air filter.
- If you use a biological chain and bar lubricant, e.g. STIHL BioPlus, completely fill the chain oil tank.
- Store the machine in a dry, high or locked location, out of the reach of children and other unauthorized persons.

## Checking and Replacing the Chain Sprocket

- Remove chain sprocket cover, saw chain and guide bar.
- Release chain brake – pull hand guard against the front handle

### Fit new chain sprocket

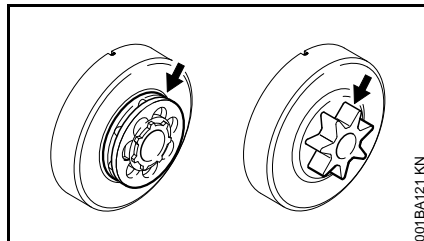

- after use of two saw chains or earlier
- if the wear marks (arrows) are deeper than 0.5 mm – otherwise the service life of the saw chain is reduced – use check gauge (special accessory) to test

Using two saw chains in alternation helps preserve the chain sprocket.

STIHL recommends use of original STIHL chain sprockets in order to ensure optimal functioning of the chain brake.

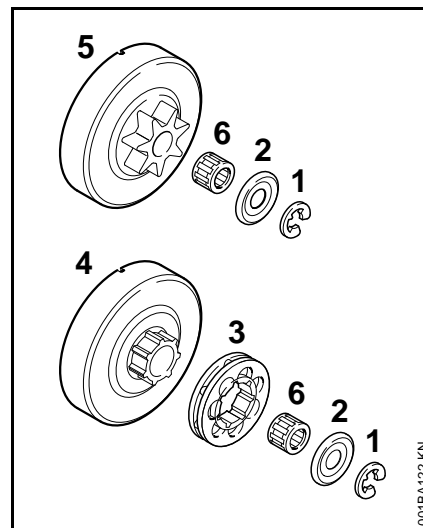

- Use a screwdriver to remove the E-clip (1)
- Remove the washer (2)
- Remove rim sprocket (3)
- Inspect transport profile on the clutch drum (4) – if there are also heavy signs of wear, also replace the clutch drum
- Remove clutch drum or spur chain sprocket (5) including needle cage (6) from the crankshaft – with QuickStop Super chain brake, press throttle trigger lockout beforehand

### Install spur chain sprocket / rim sprocket

- Clean crankshaft stub and needle cage and lubricate with STIHL lubricant (special accessory)
- Slide needle cage onto the crankshaft stub



- After refitting, turn the clutch drum and/or spur chain sprocket approx. 1 full turn so that the carrier for the oil pump drive engages – with QuickStop Super chain brake, press throttle trigger lockout beforehand
- Refit the rim sprocket – cavities toward the outside
- Refit washer and E-clip on the crankshaft

## Maintaining and Sharpening the Saw Chain

### Sawing effortlessly with a properly sharpened saw chain

A properly sharpened saw chain cuts through wood effortlessly even with very little pushing.

Never use a dull or damaged saw chain – this leads to increased physical strain, increased vibration load, unsatisfactory cutting results and increased wear.

- Clean the saw chain
- Check the saw chain for cracks and damaged rivets
- Replace damaged or worn chain components and adapt these parts to the remaining parts in terms of shape and level of wear – rework accordingly

Carbide-tipped (Duro) saw chains are especially wear-resistant. For an optimal sharpening result, STIHL recommends STIHL servicing dealers.

### **WARNING**

Compliance with the angles and dimensions listed below is absolutely necessary. An improperly sharpened saw chain – especially depth gauges that are too low – can lead to increased kickback tendency of the chain saw – **risk of injury!**

### Chain pitch

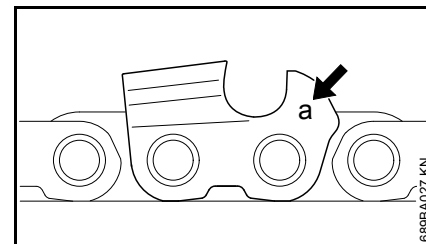

The chain pitch marking (**a**) is embossed in the area of the depth gauge of each cutter.

| Marking (a) | Chain pitch |       |
|-------------|-------------|-------|
|             | Inches      | mm    |
| 7           | 1/4 P       | 6.35  |
| 1 or 1/4    | 1/4         | 6.35  |
| 6, P or PM  | 3/8 P       | 9.32  |
| 2 or 325    | 0.325       | 8.25  |
| 3 or 3/8    | 3/8         | 9.32  |
| 4 or 404    | 0.404       | 10.26 |

The diameter of file to be used depends on the chain pitch – see table "Sharpening tools".

The angles of the cutter must be maintained during reshaping.

## Sharpening and side plate angles

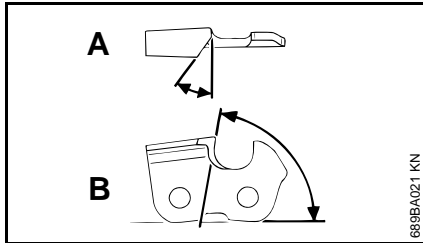

### A Sharpening angle

STIHL saw chains are sharpened with a 30° sharpening angle. Ripping chains, which are sharpened with a 10° sharpening angle, are exceptions. Ripping chains have an X in the designation.

### B Side plate angle

The correct side plate angle results automatically when the specified file holder and file diameter are used.

| Tooth shapes  | Angle (°) |    |
|---|-----------|----|
|   | A         | B  |
| Micro = semi-chisel tooth,<br>e. g., 63 PM3, 26 RM3,<br>36 RM | 30        | 75 |
| Super = full chisel tooth,<br>e. g., 63 PS3, 26 RS,<br>36 RS3 | 30        | 60 |
| Ripping chain, e. g.,<br>63 PMX, 36 RMX                       | 10        | 75 |

The angles must be identical for all cutters in the saw chain. Varying angles: Rough, uneven running of the saw chain, increased wear – even to the point of saw chain breakage.

## File holder

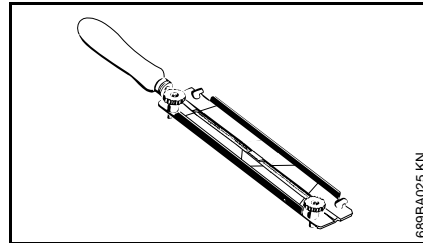

### ● Use a file holder

Always use a file holder (special accessory, see table "Sharpening tools") when sharpening saw chains by hand. File holders have markings for the sharpening angle.

**Use only special saw chain files!** Other files are unsuitable in terms of shape and type of cutting.

### To check the angles

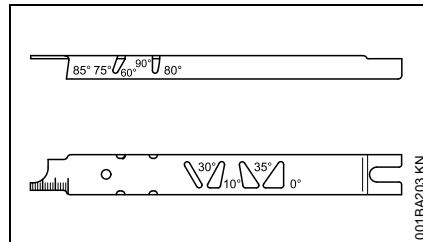

STIHL filing gauge (special accessory, see table "Sharpening tools") – a universal tool for checking sharpening and side plate angles, depth gauge setting, and tooth length, as well as cleaning grooves and oil inlet holes.

## Proper sharpening

- Select sharpening tools in accordance with chain pitch
- Clamp guide bar if necessary
- Block saw chain – push the hand guard forward
- To advance the saw chain, pull the hand guard toward the handlebar: The chain brake is disengaged. With the Quickstop Super chain brake system, additionally press the throttle trigger lockout
- Sharpen frequently, removing little material – two or three strokes of the file are usually sufficient for simple resharpenering

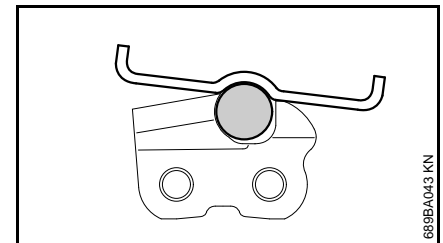
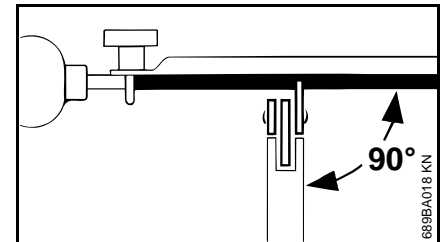

- Guide the file: **horizontally** (at a right angle to the side surface of the guide bar) in accordance with the specified angle – according to the

markings on the file holder – rest the file holder on the tooth head and the depth gauge

- File only from the inside outward
- The file only sharpens on the forward stroke – lift the file on the backstroke
- Do not file tie straps and drive links
- Rotate the file a little periodically in order to avoid uneven wear
- To remove file burr, use a piece of hardwood
- Check angle with file gauge

All cutters must be equally long.

With varying cutter lengths, the cutter heights also vary and cause rough running of the saw chain and chain breakage.

- All cutters must be filed down equal to the length of the shortest cutter – ideally, one should have this done by a servicing dealer using an electric sharpener

### Depth gauge setting

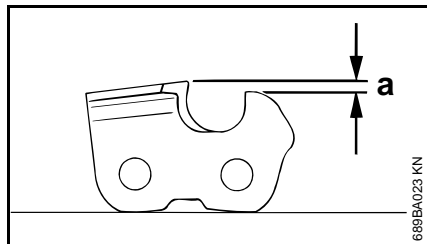

The depth gauge determines the depth to which the cutter penetrates the wood and thus the chip thickness.

- a** Required distance between depth gauge and cutting edge

When cutting softwood outside of the frost season, the distance can be increased by up to 0.2 mm (0.008").

| Chain pitch |         | Depth gauge Distance (a) |          |
|-------------|---------|--------------------------|----------|
| Inches      | (mm)    | mm                       | (Inches) |
| 1/4 P       | (6.35)  | 0.45                     | (0.018)  |
| 1/4         | (6.35)  | 0.65                     | (0.026)  |
| 3/8 P       | (9.32)  | 0.65                     | (0.026)  |
| 0.325       | (8.25)  | 0.65                     | (0.026)  |
| 3/8         | (9.32)  | 0.65                     | (0.026)  |
| 0.404       | (10.26) | 0.80                     | (0.031)  |

### Lowering the depth gauges

The depth gauge setting is lowered when the cutter is sharpened.

- Check the depth gauge setting after each sharpening

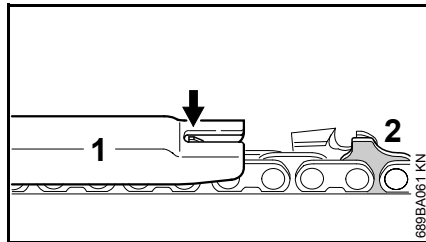

- Lay the appropriate file gauge (1) for the chain pitch on the saw chain and press it against the cutter to be checked – if the depth gauge protrudes past the file gauge, the depth gauge must be reworked

Saw chains with humped drive link (2) – upper part of the humped drive link (2) (with service mark) is lowered at the same time as the depth gauge of the cutter.



### WARNING

The rest of the humped drive link must not be filed; otherwise, this could increase the tendency of the chain saw to kick back.

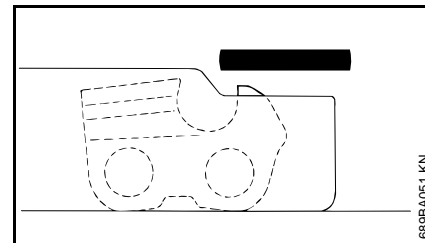

- Rework the depth gauge so that it is flush with the file gauge

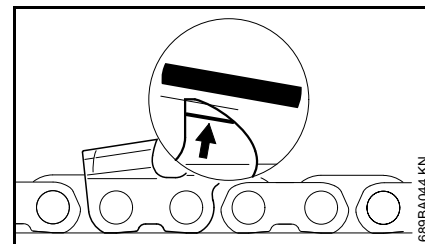

- Afterwards, dress the leading edge of the depth gauge parallel to the service mark (see arrow) – when doing this, be careful not to further lower the highest point of the depth gauge

## WARNING

Depth gauges that are too low increase the kickback tendency of the chain saw.

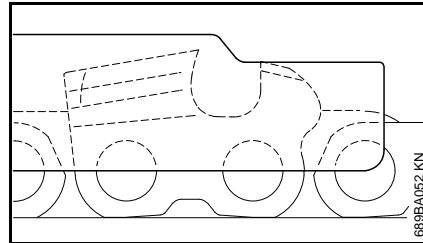

- Lay the file gauge on the saw chain – the highest point of the depth gauge must be flush with the file gauge

- After sharpening, clean the saw chain thoroughly, removing any filings or grinding dust – lubricate the saw chain thoroughly
- In the event of extended periods of disuse, store saw chains in cleaned and oiled condition

### Sharpening tools (special accessories)

| Chain pitch |         | Round file Ø |          | Round file    | File holder   | File gauge    | Taper square file | Sharpening set <sup>1)</sup> |
|-------------|---------|--------------|----------|---------------|---------------|---------------|-------------------|------------------------------|
| Inches      | (mm)    | mm           | (Inches) | Part number   | Part number   | Part number   | Part number       | Part number                  |
| 1/4P        | (6.35)  | 3.2          | (1/8)    | 5605 771 3206 | 5605 750 4300 | 0000 893 4005 | 0814 252 3356     | 5605 007 1000                |
| 1/4         | (6.35)  | 4.0          | (5/32)   | 5605 772 4006 | 5605 750 4327 | 1110 893 4000 | 0814 252 3356     | 5605 007 1027                |
| 3/8 P       | (9.32)  | 4.0          | (5/32)   | 5605 772 4006 | 5605 750 4327 | 1110 893 4000 | 0814 252 3356     | 5605 007 1027                |
| 0.325       | (8.25)  | 4.8          | (3/16)   | 5605 772 4806 | 5605 750 4328 | 1110 893 4000 | 0814 252 3356     | 5605 007 1028                |
| 3/8         | (9.32)  | 5.2          | (13/64)  | 5605 772 5206 | 5605 750 4329 | 1110 893 4000 | 0814 252 3356     | 5605 007 1029                |
| 0.404       | (10.26) | 5.5          | (7/32)   | 5605 772 5506 | 5605 750 4330 | 1106 893 4000 | 0814 252 3356     | 5605 007 1030                |

<sup>1)</sup> consisting of file holder with round file, taper square file and file gauge

## Maintenance and Care

| The following maintenance intervals apply for normal operating conditions only. When working under difficult conditions (high accumulation of dust, highly resinous lumber, lumber from tropical trees, etc.) or longer than normal each day, the specified intervals must be shortened accordingly. If you only use the tool occasionally, extend the intervals accordingly. |  | Before starting work | At the end of work and/or daily | Whenever tank is refilled | Weekly | Monthly | Annually | If faulty | If damaged | As required |
|---|--|----------------------|---------------------------------|---------------------------|--------|---------|----------|-----------|------------|-------------|
|   |  |                      |                                 |                           |        |         |          |           |            |             |
| Complete machine  | Visual inspection (condition, leaks)               | X                    |                                 | X                         |        |         |          |           |            |             |
|   | Clean  |                      | X                               |                           |        |         |          |           |            |             |
| Throttle trigger, throttle trigger lockout, choke lever, stop switch, master control lever (dependent on equipment)   | Function test                                      | X                    |                                 | X                         |        |         |          |           |            |             |
| Chain brake   | Function test                                      | X                    |                                 | X                         |        |         |          |           |            |             |
|   | Have checked by dealer <sup>1)</sup>               |                      |                                 |                           |        |         |          |           |            | X           |
| Manual fuel pump (if present)   | check  | X                    |                                 |                           |        |         |          |           |            |             |
|   | Have repaired by a specialist dealer <sup>1)</sup> |                      |                                 |                           |        |         |          |           | X          |             |
| Fuel pick-up body / filter in fuel tank   | check  |                      |                                 |                           |        | X       |          |           |            |             |
|   | Clean, replace filter insert                       |                      |                                 |                           |        | X       |          | X         |            |             |
|   | replace  |                      |                                 |                           |        |         | X        |           | X          | X           |
| Fuel tank   | Clean  |                      |                                 |                           |        | X       |          |           |            |             |
| Lubricating oil tank  | Clean  |                      |                                 |                           |        | X       |          |           |            |             |
| Chain lubrication   | check  | X                    |                                 |                           |        |         |          |           |            |             |
| Saw chain   | Check, pay attention to sharpness                  | X                    |                                 | X                         |        |         |          |           |            |             |
|   | Checking the chain tension                         | X                    |                                 | X                         |        |         |          |           |            |             |
|   | sharpen  |                      |                                 |                           |        |         |          |           |            | X           |
| Guide bar   | Check (wear, damage)                               | X                    |                                 |                           |        |         |          |           |            |             |
|   | Clean and turn over                                |                      |                                 |                           |        |         |          |           |            | X           |
|   | Deburr   |                      |                                 |                           | X      |         |          |           |            |             |
|   | replace  |                      |                                 |                           |        |         |          |           | X          | X           |
| Chain sprocket  | check  |                      |                                 |                           | X      |         |          |           |            |             |
| Air filter  | Clean  |                      |                                 |                           |        |         |          | X         |            | X           |
|   | replace  |                      |                                 |                           |        |         |          |           | X          |             |

| The following maintenance intervals apply for normal operating conditions only. When working under difficult conditions (high accumulation of dust, highly resinous lumber, lumber from tropical trees, etc.) or longer than normal each day, the specified intervals must be shortened accordingly. If you only use the tool occasionally, extend the intervals accordingly. |   | Before starting work | At the end of work and/or daily | Whenever tank is refilled | Weekly | Monthly | Annually | If faulty | If damaged | As required |
|---|---|----------------------|---------------------------------|---------------------------|--------|---------|----------|-----------|------------|-------------|
| Anti-vibration elements   | check   | X                    |                                 |                           |        |         |          | X         |            |             |
|   | Have replaced by servicing dealer <sup>1)</sup>   |                      |                                 |                           |        |         |          |           | X          |             |
| Air intake on fan housing   | Clean   |                      | X                               |                           | X      |         |          |           |            | X           |
| Cylinder fins   | Clean   |                      | X                               |                           |        | X       |          |           |            |             |
| Carburetor  | Check idle adjustment – saw chain must not rotate   | X                    |                                 | X                         |        |         |          |           |            |             |
|   | Set the idle speed; if required have the chainsaw repaired by a specialist dealer <sup>1)</sup> |                      |                                 |                           |        |         |          |           |            | X           |
| Spark plug  | Adjust electrode gap  |                      |                                 |                           |        |         |          | X         |            |             |
|   | Replace after 100 hours of operation  |                      |                                 |                           |        |         |          |           |            |             |
| Accessible screws and nuts (except adjusting screws)  | Tighten <sup>2)</sup>   |                      |                                 |                           |        |         |          |           |            | X           |
| Spark arresting screen in muffler   | Have checked by dealer <sup>1)</sup>  |                      |                                 |                           |        |         |          | X         |            |             |
|   | Have cleaned; if required have replaced by specialist dealer <sup>1)</sup>                      |                      |                                 |                           |        |         |          |           | X          |             |
| Chain catcher   | check   | X                    |                                 |                           |        |         |          |           |            |             |
|   | replace   |                      |                                 |                           |        |         |          |           | X          |             |
| Safety information label  | replace   |                      |                                 |                           |        |         |          | X         |            |             |

1) STIHL recommends STIHL servicing dealer

2) When using professional chainsaws (with a power output of 3.4 kW or more) for the first time, tighten the cylinder block screws after 10 to 20 hours of operation

## Main Parts

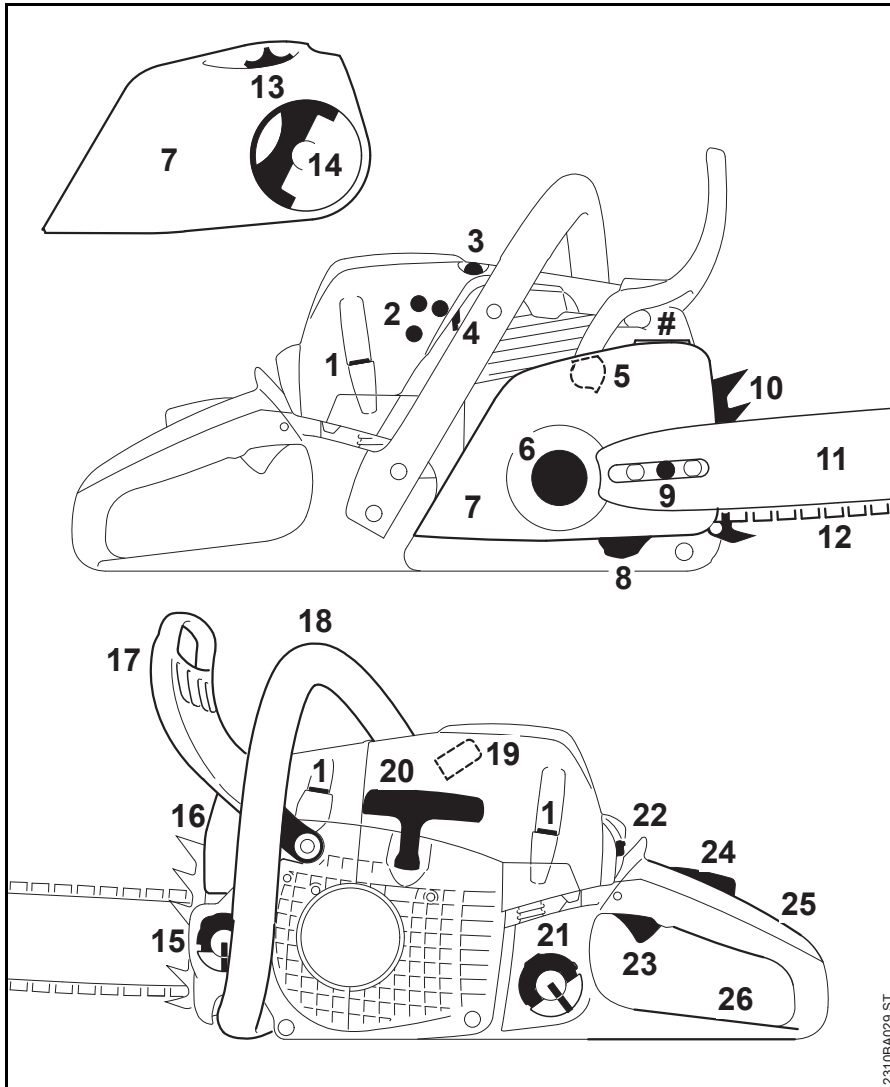

- 1 Shroud lock
- 2 Carburetor adjusting screws
- 3 Fuel pump<sup>1)</sup>
- 4 Shutter (summer and winter operation)
- 5 Chain brake
- 6 Chain sprocket
- 7 Chain sprocket cover
- 8 Chain catcher
- 9 Side chain tensioner<sup>1)</sup>
- 10 Spiked bumper
- 11 Guide bar
- 12 Oilomatic chain
- 13 Adjusting wheel<sup>1)</sup> (quick chain adjuster)
- 14 Handle of wingnut<sup>1)</sup> (quick chain adjuster)
- 15 Oil filler cap
- 16 Muffler
- 17 Front hand guard
- 18 Front handle (handlebar)
- 19 Spark plug boot
- 20 Starter grip
- 21 Fuel filler cap
- 22 Master Control lever
- 23 Throttle trigger
- 24 Throttle trigger lockout
- 25 Rear handle
- 26 Rear hand guard
- # Serial number

1) Depending on model

## Specifications

### Engine

STIHL single cylinder two-stroke engine

#### MS 231, MS 231 C

|                           |                                |
|---------------------------|--------------------------------|
| Displacement:             | 42.6 cc                        |
| Bore:                     | 42.5 mm                        |
| Stroke:                   | 30 mm                          |
| Engine power to ISO 7293: | 2.0 kW (2.7 bhp) at 10,000 rpm |
| Idle speed: <sup>1)</sup> | 2,800 rpm                      |

#### MS 251, MS 251 C

|                           |                                |
|---------------------------|--------------------------------|
| Displacement:             | 45.6 cc                        |
| Bore:                     | 44 mm                          |
| Stroke:                   | 30 mm                          |
| Engine power to ISO 7293: | 2.2 kW (3.0 bhp) at 10,000 rpm |
| Idle speed: <sup>1)</sup> | 2,800 rpm                      |

<sup>1)</sup> to ISO 11681 +/- 50 rpm

### Ignition System

Electronic magneto ignition

Spark plug (resistor type): NGK CMR6H, BOSCH USR 4 A C

Electrode gap: 0.5 mm

### Fuel System

All position diaphragm carburetor with integral fuel pump

Fuel tank capacity: 390 cc (0.39 l)

### Chain Lubrication

Fully automatic, speed-controlled oil pump with rotary piston

Oil tank capacity: 200 cc (0.2 l)

### Weight

dry, without bar and chain

MS 231: 4.8 kg

MS 231 C with ErgoStart and quick chain tensioner: 5.1 kg

MS 251: 4.8 kg

MS 251 C with ErgoStart and quick chain tensioner: 5.1 kg

### Cutting Attachment

Actual cutting length may be less than the specified length

#### .325" Rollomatic E guide bars

Cutting lengths: 35, 40, 45 cm

Pitch: .325" (8.25 mm)

Groove width: 1.6 mm

Nose sprocket: 11-tooth

#### 3/8" P Rollomatic E guide bars

Cutting lengths: 30, 35, 40, 45 cm

Pitch: 3/8" P (9.32 mm)

Groove width: 1.3 mm

Nose sprocket: 9-tooth

#### .325" chain

Rapid Micro 3 (26 RM3) Type 3634

Rapid Duro 3 (26 RD3) Type 3667

Pitch: .325" (8.25 mm)

Drive link gauge: 1.6 mm

#### 3/8" P chain

Picco Micro 3 (63 PM3) Type 3636

Picco Super 3 (63 PS3) Type 3616

Picco Duro 3 (63 PD3) Type 3612

Pitch: 3/8" P (9.32 mm)

Drive link gauge: 1.3 mm

#### Chain sprocket

7-tooth for .325"

Max. chain velocity to ISO 11681: 25.6 m/s

Chain speed at maximum power output: 19.3 m/s

6-tooth for 3/8" P

Max. chain velocity to ISO 11681: 24.8 m/s

Chain speed at maximum power output: 18.6 m/s

#### Noise and Vibration Data

For further details on compliance with Vibration Directive 2002/44/EC see [www.stihl.com/vib](http://www.stihl.com/vib).

#### Sound pressure level $L_p$ to ISO 22868

MS 231: 103 dB(A)

MS 231 C: 103 dB(A)

MS 251: 103 dB(A)

MS 251 C: 103 dB(A)

MS 231, MS 231 C, MS 251, MS 251 C



**Sound power level  $L_w$  to ISO 22868**

|           |           |
|-----------|-----------|
| MS 231:   | 114 dB(A) |
| MS 231 C: | 114 dB(A) |
| MS 251:   | 114 dB(A) |
| MS 251 C: | 114 dB(A) |

**Vibration measurement  $a_{hv, eq}$  to ISO 22867**

|           | Handle, left         | Handle, right        |
|-----------|----------------------|----------------------|
| MS 231:   | 3.9 m/s <sup>2</sup> | 3.9 m/s <sup>2</sup> |
| MS 231 C: | 3.9 m/s <sup>2</sup> | 3.9 m/s <sup>2</sup> |
| MS 251:   | 3.9 m/s <sup>2</sup> | 3.9 m/s <sup>2</sup> |
| MS 251 C: | 3.9 m/s <sup>2</sup> | 3.9 m/s <sup>2</sup> |

The K-factor in accordance with Directive 2006/42/EC is 2.0 dB(A) for the sound pressure level and sound power level; the K-factor in accordance with Directive 2006/42/EC is 2.0 m/s<sup>2</sup> for the vibration level.

**REACH**

REACH is an EC regulation and stands for the Registration, Evaluation, Authorisation and Restriction of Chemical substances.

For information on compliance with the REACH regulation (EC) No. 1907/2006 see [www.stihl.com/reach](http://www.stihl.com/reach).

**Exhaust Emissions**

The CO<sub>2</sub> value measured in the EU type approval procedure is specified at [www.stihl.com/co2](http://www.stihl.com/co2).

The measured CO<sub>2</sub> value was determined on a representative engine in accordance with a standardized test procedure under laboratory conditions and does not represent either an explicit or implied guarantee of the performance of a specific engine.

The applicable exhaust emission requirements are fulfilled by the intended usage and maintenance described in this instruction manual. The type approval expires if the engine is modified in any way.

**Ordering Spare Parts**

Please enter your saw model, serial number as well as the part numbers of the guide bar and saw chain in the spaces provided. This will make re-ordering simpler.

The guide bar and saw chain are subject to normal wear and tear. When purchasing these parts, always quote the saw model, the part numbers and names of the parts.

Model

|  |  |  |  |  |  |  |  |  |  |  |  |  |  |  |  |  |  |  |  |  |
|--|--|--|--|--|--|--|--|--|--|--|--|--|--|--|--|--|--|--|--|--|
|  |  |  |  |  |  |  |  |  |  |  |  |  |  |  |  |  |  |  |  |  |
|--|--|--|--|--|--|--|--|--|--|--|--|--|--|--|--|--|--|--|--|--|

Serial number

|  |  |  |  |  |  |  |  |  |  |  |  |  |  |  |  |  |  |  |  |  |
|--|--|--|--|--|--|--|--|--|--|--|--|--|--|--|--|--|--|--|--|--|
|  |  |  |  |  |  |  |  |  |  |  |  |  |  |  |  |  |  |  |  |  |
|--|--|--|--|--|--|--|--|--|--|--|--|--|--|--|--|--|--|--|--|--|

Guide bar part number

|  |  |  |  |  |  |  |  |  |  |  |  |  |  |  |  |  |  |  |  |  |
|--|--|--|--|--|--|--|--|--|--|--|--|--|--|--|--|--|--|--|--|--|
|  |  |  |  |  |  |  |  |  |  |  |  |  |  |  |  |  |  |  |  |  |
|--|--|--|--|--|--|--|--|--|--|--|--|--|--|--|--|--|--|--|--|--|

Chain part number

|  |  |  |  |  |  |  |  |  |  |  |  |  |  |  |  |  |  |  |  |  |
|--|--|--|--|--|--|--|--|--|--|--|--|--|--|--|--|--|--|--|--|--|
|  |  |  |  |  |  |  |  |  |  |  |  |  |  |  |  |  |  |  |  |  |
|--|--|--|--|--|--|--|--|--|--|--|--|--|--|--|--|--|--|--|--|--|

## Maintenance and Repairs

Users of this machine may only carry out the maintenance and service work described in this user manual. All other repairs must be carried out by a servicing dealer.

STIHL recommends that you have servicing and repair work carried out exclusively by an authorized STIHL servicing dealer. STIHL dealers are regularly given the opportunity to attend training courses and are supplied with the necessary technical information.

When repairing the machine, only use replacement parts which have been approved by STIHL for this power tool or are technically identical. Only use high-quality replacement parts in order to avoid the risk of accidents and damage to the machine.

STIHL recommends the use of original STIHL replacement parts.

Original STIHL parts can be identified by the STIHL part number, the **STIHL** logo and the STIHL parts symbol  (the symbol may appear alone on small parts).

## Disposal

Observe all country-specific waste disposal rules and regulations.

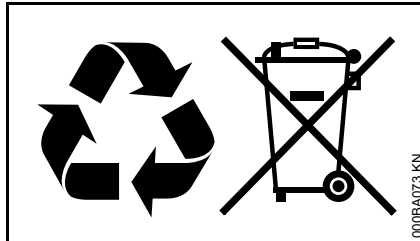

STIHL products must not be thrown in the garbage can. Take the product, accessories and packaging to an approved disposal site for environment-friendly recycling.

Contact your STIHL servicing dealer for the latest information on waste disposal.

## EC Declaration of Conformity

ANDREAS STIHL AG & Co. KG  
Badstr. 115  
D-71336 Waiblingen

Germany

declare in exclusive responsibility that the product

|           |             |
|-----------|-------------|
| Category: | Chainsaw    |
| Make:     | STIHL       |
| Model:    | MS 231      |
|           | MS 231 C    |
|           | MS 231 C-BE |
|           | MS 251      |
|           | MS 251 C    |
|           | MS 251 C-BE |

Serial identification: 1143

Displacement

all versions of MS 231: 42.6 cm<sup>3</sup>

all versions of MS 251: 45.6 cm<sup>3</sup>

conforms to the provisions of Directives 2011/65/EU, 2006/42/EC, 2014/30/EU and 2000/14/EC and has been developed and manufactured in compliance with the following standards in the versions valid at the time of production:

EN ISO 11681-1, EN 55012,  
EN 61000-6-1

The measured and guaranteed sound power levels were determined according to Directive 2000/14/EC, Annex V, using the ISO 9207 standard.

### Measured sound power level

all versions of MS 231: 114 dB(A)

all versions of MS 251: 114 dB(A)

MS 231, MS 231 C, MS 251, MS 251 C

### Guaranteed sound power level

all versions of MS 231: 116 dB(A)

all versions of MS 251: 116 dB(A)

The EC type examination was carried out by

DPLF

Deutsche Prüf- und Zertifizierungsstelle  
für Land- und Forsttechnik (NB 0363)

Max-Eyth-Weg 1

D-64823 Gross-Umstadt

Certification No.

all versions of       K-EG-2010/5603

MS 231:

all versions of       K-EG-2010/5605

MS 251:

Technical documents deposited at:

ANDREAS STIHL AG & Co. KG  
Produktzulassung (Product Licensing)

The year of manufacture and serial  
number are applied to the product.

Done at Waiblingen, 03.02.2020

ANDREAS STIHL AG & Co. KG

p p.



Dr. Jürgen Hoffmann

Head of Product Data, Regulations and  
Licensing



0458-737-8321-B

AUS



[www.stihl.com](http://www.stihl.com)



0458-737-8321-B