

GTA 26

STIHL



2 - 27 Instruction Manual



Contents

1	Introduction.....	2
2	Guide to Using this Manual.....	2
3	Overview.....	3
4	Safety Precautions.....	4
5	Preparing Garden Pruner for Operation.....	12
6	Charging the Battery, LEDs.....	12
7	Assembling the Garden Pruner.....	13
8	Removing and Fitting the Battery.....	14
9	Switching On and Off.....	15
10	Checking the Garden Pruner and Battery.....	15
11	Using the Garden Pruner.....	16
12	After Finishing Work.....	17
13	Transporting.....	17
14	Storing.....	17
15	Cleaning.....	18
16	Maintenance.....	18
17	Repairing.....	19
18	Troubleshooting.....	19
19	Specifications.....	21
20	Bar and Chain Combinations.....	22
21	Spare Parts and Accessories.....	22
22	Disposal.....	22
23	EC Declaration of Conformity.....	22
24	UKCA Declaration of Conformity.....	23
25	Addresses.....	23
26	General Power Tool Safety Warnings.....	24

1 Introduction

Dear Customer,

Thank you for choosing STIHL. We develop and manufacture our quality products to meet our customers' requirements. The products are designed for reliability even under extreme conditions.

STIHL also stands for premium service quality. Our dealers guarantee competent advice and instruction as well as comprehensive service support.

STIHL expressly commit themselves to a sustainable and responsible handling of natural resources. This user manual is intended to help you use your STIHL product safely and in an environmentally friendly manner over a long service life.

We thank you for your confidence in us and hope you will enjoy working with your STIHL product.



Dr. Nikolas Stihl

IMPORTANT! READ BEFORE USING AND KEEP IN A SAFE PLACE FOR REFERENCE.

2 Guide to Using this Manual

2.1 Applicable Documentation

Local safety regulations apply.

- ▶ Read, understand and save the following documents in addition to this instruction manual:
 - Information on STIHL Multioil Bio: www.stihl.com/safety-data-sheets
 - Safety information for STIHL batteries and products with built-in batteries: [www.stihl.com/safety-data-sheets](http://www.stihl.com/safety-data-sheetswww.stihl.com/safety-data-sheets)

2.2 Warning Notices in Text



- This notice refers to risks which result in serious or fatal injury.
 - ▶ Serious or fatal injuries can be avoided by taking the precautions mentioned.



- This notice refers to risks which **can** result in serious or fatal injury.
 - ▶ Serious or fatal injuries can be avoided by taking the precautions mentioned.

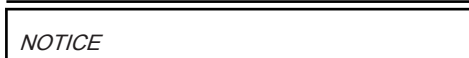

- This notice refers to risks which can result in damage to property.
 - ▶ Damage to property can be avoided by taking the precautions mentioned.

2.3 Symbols in Text



This symbol refers to a chapter in this instruction manual.

3 Overview

3.1 Garden Pruner, Battery and Charger

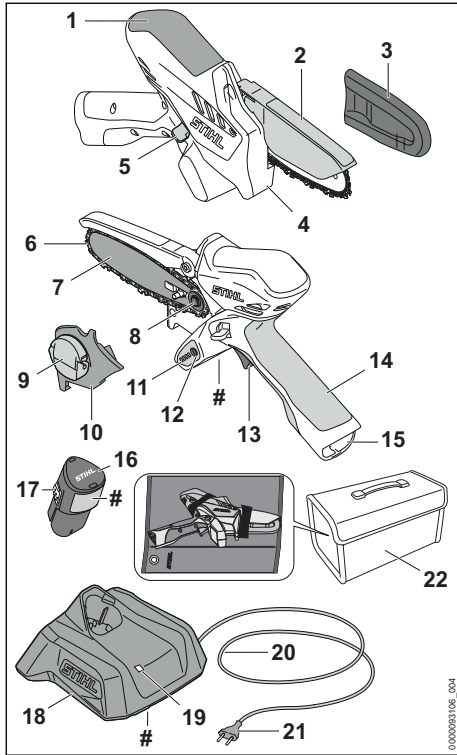

- 1 Grip**
For holding and controlling the garden pruner.
- 2 Protective hood**
Helps protect user from contact with saw chain.
- 3 Chain scabbard**
The chain scabbard protects against contact with the saw chain.
- 4 Limit stop**
Supports the garden pruner against wood while cutting.
- 5 Locking lever**
The locking lever unlocks the trigger.
- 6 Saw chain**
The saw chain cuts the wood.
- 7 Guide bar**
The guide bar supports and guides the saw chain.

- 8 Chain sprocket**
The chain sprocket drives the saw chain.
- 9 Wing nut**
Secures the chain sprocket cover to the garden pruner.
- 10 Chain sprocket cover**
Covers the chain sprocket and secures the guide bar to the garden pruner.
- 11 LEDs**
The LEDs indicate the state of charge of the battery and any faults.
- 12 Pushbutton**
Activates the LEDs on the garden pruner.
- 13 Trigger**
Switches the garden pruner on and off.
- 14 Control handle**
For operating, holding and controlling the garden pruner.
- 15 Battery compartment**
The battery compartment holds the battery.
- 16 Battery**
Supplies power to the garden pruner.
- 17 Locking hook**
Holds the battery in the battery compartment.
- 18 Charger**
The charger charges the battery.
- 19 LED**
The LED indicates the status of the charger.
- 20 Connecting cable**
The connecting cable connects the charger to the mains plug.

- 21 Mains plug**
The mains plug connects the connecting cable with a socket
- 22 Bag**
For transporting and storing the garden pruner, battery and charger. The bag only comes with the set (consisting of garden pruner, battery and charger).

Rating plate with the machine number

3.2 Symbols

Meanings of symbols that may be on the garden pruner, battery and charger:



This symbol shows the direction of rotation of the saw chain.



The LED lights up steady or flashes green. The battery is charging.



The LED flashes red. There is no electrical contact between the battery and the charger, or there is a fault in the battery or in the charger.



Length of guide bar that may be used.



Guaranteed sound power level in accordance with Directive 2000/14/EC in dB(A) for the purpose of comparing the sound emissions of products.



The information next to the symbol indicates the energy content of the battery according to the cell manufacturer's specification. The energy content available in operation is lower.



Operate the electric product in a dry place, indoors only.



Do not dispose of the product with your household waste.



Read and understand the user manual and keep it in a safe place for reference.

4 Safety Precautions

4.1 Warning symbols

Meanings of warning signs on the garden pruner, battery or charger:



Observe safety notices and take the necessary precautions.



Read and understand the user manual and keep it in a safe place for reference.



Wear safety glasses.



Hold the garden pruner firmly with both hands.



Avoid contact of guide bar nose with objects. This can lead to a sudden kickback in the direction of the user and cause serious injuries.



Do not touch the moving saw chain.



Remove the battery during work interruptions, transport, storage, maintenance or repair.



Protect garden pruner and charger from rain and dampness.



Protect the battery against heat and fire.



Protect the battery against rain and moisture and do not immerse it in liquids.

4.2 Intended Use

The STIHL GTA 26 garden pruner is designed to cut wood.

The garden pruner must not be used in the rain.

The STIHL AS battery supplies power to the garden pruner.

The STIHL AL 1 charger recharges the STIHL AS battery.

▲ WARNING

- Batteries and chargers not approved for the garden pruner by STIHL may cause a fire or explosion. This can result in serious or fatal injuries and damage to property.
 - ▶ Use the garden pruner with a STIHL AS battery.
 - ▶ Recharge the STIHL AS battery with a STIHL AL 1 charger.
- Using the garden pruner, battery or the charger for purposes for which they were not designed may result in serious or fatal injuries, and damage to property may occur.
 - ▶ Use the garden pruner, battery and charger as described in this instruction manual.

4.3 The Operator

▲ WARNING

- Users without adequate training or instruction cannot recognize or assess the risks involved in using the garden pruner, battery and charger. The user or other persons may sustain serious or fatal injuries.



▶ Read, understand and save the instruction manual.

- ▶ If you lend the garden pruner, battery or charger to another person: Always give them the instruction manual.
- ▶ Make sure the user meets the following requirements:
 - The user must be rested.

– The user must be in good physical condition and mental health to operate and work with the garden pruner, battery and charger. If the user's physical, sensory or mental ability is restricted, he or she may work only under the supervision of or as instructed by a responsible person.

- The user is able to recognize and assess the risks involved in using the garden pruner, battery and charger.
- The user must be of legal age or is being trained in a trade under supervision in accordance with national rules and regulations.
- The user has received instruction from a STIHL servicing dealer or other experienced user before working with the garden pruner for the first time.
- The user must not be under the influence of alcohol, medication or drugs.
- ▶ If you have any queries: Contact a STIHL servicing dealer for assistance.

4.4 Clothing and equipment

▲ WARNING

- Long hair can be pulled into the garden pruner during operation. This may result in serious injury to the user.
 - ▶ Tie up and confine long hair above your shoulders.
- Objects can be thrown at high speed during operation. This may result in injury to the user.



- ▶ Wear close-fitting safety glasses. Suitable safety glasses are tested in accordance with EN 166 or national regulations and available commercially with the corresponding marking.
- ▶ Wear long trousers.
- Falling objects can cause head injuries.
 - ▶ If objects are likely to fall while working: wear a hard hat.

- Dust can be whipped up during operation: Whipped up dust can damage the respiratory passages and cause allergic reactions.
 - ▶ If dust is generated: Wear a dust respirator mask.
- Inappropriate clothing can snag on wood, brush or the garden pruner. Not wearing suitable clothing may result in serious injury.
 - ▶ Wear close-fitting clothing.
 - ▶ Remove scarves and jewelry.
- The user may cut himself or herself on wood while working. The user may come into contact with the saw chain during cleaning or servicing. This may result in injury to the user.
 - ▶ Wear work gloves made from resistant material.
- Wearing unsuitable footwear may cause the user to slip. This may result in injury to the user.
 - ▶ Wear sturdy, closed-toed footwear with high-grip soles.

4.5 Work Area and Surroundings

4.5.1 Garden pruner

▲ WARNING

- Innocent bystanders, children and animals are not aware of the dangers of the garden pruner or flying debris. Bystanders, children and animals may be seriously injured and damage to property may occur.
 - ▶ Keep bystanders, children and animals away from the work area.
 - ▶ Do not leave the garden pruner unattended.
 - ▶ Make sure that children cannot play with the garden pruner.
- The garden pruner is not waterproof. Working in the rain or a damp location may result in an electric shock. This can result in injuries to the user and may damage the garden pruner.
 - ▶ Do not work in the rain or a damp location.



- Electrical components of the garden pruner can produce sparks. Sparks may cause a fire or an explosion in an easily combustible or explosive environment. This can result in serious or fatal injuries and damage to property.
 - ▶ Do not work in an easily combustible or explosive environment.

4.5.2 Battery

▲ WARNING

- Bystanders, children and animals cannot recognize or assess the dangers of the battery. Bystanders, children and animals may be seriously injured.
 - ▶ Keep bystanders, children and animals away from the work area.
 - ▶ Do not leave the battery unattended.
 - ▶ Make sure that children cannot play with the battery.
- The battery is not protected against all ambient conditions. If the battery is exposed to certain ambient conditions, the battery may catch fire, explode or be irreparably damaged. This may result in serious injury to people and damage to property.



- ▶ Protect battery from heat and fire.
- ▶ Do not throw the battery into a fire.

- ▶ Do not charge, use and store the battery outside of the specified temperature limits,  19.7.



- ▶ Protect the battery from rain and moisture and do not immerse it in liquids.

- ▶ Keep battery away from small metal parts.
- ▶ Do not expose the battery to high pressure.
- ▶ Do not expose the battery to microwaves.
- ▶ Protect the battery from chemicals and salts.

4.5.3 Charger

▲ WARNING

- Bystanders and children are not aware of and cannot assess the dangers of a charger or electric current. Bystanders, children and animals may be seriously or fatally injured.
 - ▶ Keep bystanders, children and animals away from the work area.
 - ▶ **Make sure that children cannot play with the charger.**
- The charger is not waterproof. If you work in the rain or in a damp environment, an electric shock may occur. The user may be injured and the charger may be damaged.



- ▶ Do not operate it in the rain or in a damp environment.

- The charger is not protected against all ambient conditions. If the charger is exposed to

certain ambient conditions, it may catch fire or explode. This may result in serious injury to people and damage to property.

- ▶ Operate the charger in an enclosed, dry room.
- ▶ Do not operate the charger in a flammable environment or in an explosive environment.
- ▶ Do not operate the charger on a readily combustible surface.
- ▶ Do not use and store the charger outside of the specified temperature limits,  19.7.
- The connecting cable is a trip hazard. People may be injured and the charger may be damaged.
 - ▶ Lay the connecting cable flat on the floor.

4.6 Safe Condition

4.6.1 Garden pruner

The garden pruner is in a safe condition if the following points are observed:

- Garden pruner is not damaged.
- Garden pruner is clean and dry.
- Chain guard is mounted.
- The chain guard is undamaged and has not been modified.
- The controls function properly and have not been modified.
- The saw chain is lubricated.
- Wear marks on the chain sprocket are not deeper than 0.5 mm.
- A combination of guide bar and saw chain recommended in this User Manual is mounted.
- The guide bar and saw chain are properly mounted.
- The saw chain is properly tensioned.
- Genuine STIHL accessories designed for this garden pruner model are installed.
- The accessories are correctly attached.

▲ WARNING

- If not in safe condition, components may no longer operate correctly and safety devices may be disabled. There is a risk of serious or fatal injury.
 - ▶ Work only with an undamaged garden pruner.
 - ▶ If the garden pruner is dirty or wet: Clean the garden pruner and allow it to dry.
 - ▶ Never modify the garden pruner. Exception: Mounting a combination of guide bar and saw chain recommended in this User Manual.
 - ▶ Never use the garden pruner without the chain guard.

- ▶ If the chain guard is damaged or has been modified: Do not work with the garden pruner.
- ▶ If the controls do not function properly: Do not work with the garden pruner.
- ▶ Fit genuine STIHL accessories designed for this garden pruner model.
- ▶ Mount the guide bar and saw chain as described in this User Manual.
- ▶ Attach accessories as described in this user manual or in the user manual for the accessories.
- ▶ Never insert objects into the garden pruner's openings.
- ▶ Replace worn or damaged labels.
- ▶ If you have any doubts, be sure to consult a STIHL dealer.

4.6.2 Guide bar

The guide bar is in a safe condition if the following points are observed:

- Guide bar is not damaged.
- Guide bar is not deformed.
- At least the minimum groove depth is maintained,  19.3.
- Bar groove is not pinched or splayed.

▲ WARNING

- If the guide bar is not in a safe condition, it can no longer support and guide the saw chain properly. The rotating saw chain can jump off the guide bar. This can result in serious or fatal injuries.
 - ▶ Work only with an undamaged guide bar.
 - ▶ If the groove depth is less than the minimum depth: Replace the guide bar.
 - ▶ If you have any queries: Contact a STIHL servicing dealer for assistance.

4.6.3 Saw Chain

The saw chain is in a safe condition if the following points are observed:

- Chain is not damaged.
- Chain is properly sharpened.
- The service marks on the cutters are still visible.

▲ WARNING

- If components do not comply with safety requirements, they will no longer function properly and safety devices may be rendered inoperative. This can result in serious or fatal injuries.
 - ▶ Work only with an undamaged saw chain.
 - ▶ Sharpen the chain properly.

- ▶ If you have any queries: Contact your STIHL servicing dealer for assistance.

4.6.4 Battery

The battery is in a safe condition if the following points are observed:

- Battery is undamaged.
- The battery is clean and dry.
- Battery functions properly and has not been modified.

▲ WARNING

- A battery that is not in a safe condition cannot operate safely. Persons may be seriously injured.
 - ▶ Never work with a damaged battery.
 - ▶ Never attempt to charge a damaged or defective battery.
 - ▶ If the battery is dirty: Clean the battery.
 - ▶ If the battery is wet or damp: Allow the battery to dry,  19.8.
 - ▶ Never attempt to modify the battery.
 - ▶ Never insert objects in the battery's openings.
 - ▶ Never bridge the battery's contacts with metallic objects (short circuit).
 - ▶ Do not open the battery.
 - ▶ Replace worn or damaged labels.
- Fluid may leak from a damaged battery. If that liquid comes into contact with the skin or eyes, the skin or eyes may be irritated.
 - ▶ Avoid contact with the liquid.
 - ▶ If skin contact occurs: Wash affected areas of skin with plenty of water and soap.
 - ▶ In the event of contact with eyes: Rinse eyes with plenty of water for at least 15 minutes and consult a doctor.
- A damaged or defective battery may smell unusual, emit smoke or burn. Persons may be seriously or fatally injured, and property may be damaged.
 - ▶ If the battery smells unusual or emits smoke: do not use the battery and keep it away from combustible substances.
 - ▶ If the battery catches fire: Attempt to extinguish the battery with a fire extinguisher or water.

4.6.5 Charger

The charger is in a safe condition if the following points are observed:

- Charger is undamaged.
- Charger is clean and dry.

▲ WARNING

- If components do not comply with safety requirements, they will no longer function properly and safety devices may be rendered inoperative. This can result in serious or fatal injuries.
 - ▶ Do not use a damaged charger.
 - ▶ If the charger is dirty or wet: Clean the charger and allow it to dry.
 - ▶ Never attempt to modify the charger.
 - ▶ Never insert objects in the charger's openings.
 - ▶ Never bridge the charger's contacts with metallic objects (short circuit).
 - ▶ Do not open the charger.

4.7 Operation

▲ WARNING

- Always work within calling distance of others in case help is needed.
 - ▶ Make sure that persons outside the work area are within calling distance.
- The user cannot concentrate on the work in certain situations. The user can lose control of the garden pruner, stumble or fall and be seriously injured.
 - ▶ Work calmly and carefully.
 - ▶ If light and visibility are poor: Do not work with the garden pruner.
 - ▶ Operate the garden pruner alone.
 - ▶ Do not work above shoulder height.
 - ▶ Watch out for obstacles.
 - ▶ Stand on the ground while working and keep a good balance. If it is necessary to work at heights: Use a lift bucket or a safe platform.
 - ▶ If you begin to feel tired: Take a break.
- The rotating saw chain can cut the operator. This can result in serious injuries.
 - ▶ Do not touch the rotating saw chain.
 - ▶ If the saw chain is blocked by an object: Switch off the garden pruner and remove the battery. Then remove the object causing the blockage.
- The rotating chain becomes hot and expands. If the chain is not lubricated sufficiently or not re-tensioned at regular intervals, it may come off the guide bar or break. This can result in serious injuries and damage to property.
 - ▶ Use STIHL Multioil Bio or an equivalent biodegradable multifunctional oil.
 - ▶ Lubricate the saw chain after every break to recharge the battery.

- ▶ Check chain tension regularly during cutting work. If chain tension is insufficient: Tension the chain.
- The guide bar, saw chain and chain sprocket can become hot during operation. There is a risk of burn injuries.
 - ▶ Do not touch the hot guide bar, saw chain or chain sprocket.
 - ▶ Wait for the guide bar, saw chain and chain sprocket to cool down.
 - ▶ Wear work gloves made of durable material.
- If the behavior of the garden pruner changes during operation or feels unusual, it may no longer be in a safe condition. This can result in serious injuries and damage to property.
 - ▶ Stop work, remove the battery and contact your STIHL servicing dealer for assistance.
- Vibrations may occur while using the garden pruner.
 - ▶ Wear gloves.
 - ▶ Take regular breaks.
 - ▶ If signs of circulation problems occur: Seek medical advice.
- Sparks may occur if the rotating chain makes contact with a hard object. Sparks may cause a fire in an easily combustible location. This can result in serious or fatal injuries and damage to property.
 - ▶ Do not work in an easily combustible location.
- Note that the saw chain continues to rotate for a short period after you release the trigger. The rotating saw chain can cut the user. This can result in serious injuries.
 - ▶ Wait for the chain to come to a standstill.

▲ DANGER

- Working near live electric cables can result in accidental contact with the chain and damage the cables. This can result in serious or fatal injuries.
 - ▶ Do not work near live electric cables.

4.8 Reactive Forces

4.8.1 Reactive Forces

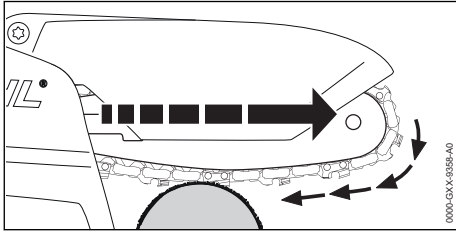

The garden pruner is pulled away from the operator when the bottom of the bar is used for cutting.

⚠ WARNING

- If the rotating chain makes contact with a hard object and is suddenly pinched, the garden pruner is abruptly jerked away from the operator. This can result in personal injuries.
 - ▶ Hold the garden pruner firmly with both hands.
 - ▶ Use the working techniques described in this instruction manual.
 - ▶ Work with the chain guard properly mounted.
 - ▶ Work with an undamaged chain guard that has not been modified.
 - ▶ Always cut with a properly sharpened and tensioned saw chain.
 - ▶ Keep the guide bar straight in the cut.
 - ▶ Apply the stop properly.
 - ▶ Cut with the motor running at full speed.

4.9 Charging

⚠ WARNING

- A damaged or defective charger may produce an unusual smell or emit smoke during the charging process. This may result in personal injuries and damage to property.
 - ▶ Disconnect the plug from the wall outlet.
- The charger can overheat and cause a fire if heat dissipation is inadequate. This can result in serious or fatal injuries and damage to property.
 - ▶ Do not cover the charger.

4.10 Connecting to the power supply

Contact with live components may occur for the following reasons:

- The connecting cable or the extension cord is damaged.

- The mains plug of the connecting cable or extension cord is damaged.
- The socket is not properly installed.

⚠ DANGER

- Contact with live parts may result in electric shock. This may result in serious or fatal injury to the user.

- ▶ Make sure that the connecting cable, extension cord and their mains plugs are undamaged.



If the connecting cable or the extension cord is damaged:

- ▶ Do not touch the damaged area.
- ▶ Disconnect the mains plug from the power supply.
- ▶ Make sure your hands are dry before touching the connecting cable, extension cord or mains plugs.
- ▶ Plug the mains plug of the connecting cable or extension cord into a properly installed, shockproof socket with the correct fuse rating.
- ▶ Install the charger with a ground fault circuit interrupter (30 mA, 30 ms).
- A damaged or unsuitable extension cable can result in electric shock. There is a risk of serious or fatal injury.
 - ▶ Use an extension cable with the correct cable cross-section, 19.6.

⚠ WARNING

- Overvoltage can occur in the charger if the line voltage or frequency are incorrect during charging. The charger may be damaged.
 - ▶ Make sure that the mains voltage and the mains frequency of the power supply match the data on the rating plate of the charger.
- If the charger is connected to a power strip, electrical components may be overloaded during the charging process. The components may overheat and cause a fire. Persons may be seriously or fatally injured, and property may be damaged.
 - ▶ Ensure that the technical specifications for the power strip are not exceeded by the information on the rating plate of the charger and of all electrical devices connected to the power strip.
- An incorrectly routed connecting cable or extension cord may be damaged, and people may trip over it. People may be injured, and the connecting cable or extension cord may be damaged.

- ▶ Route and mark the connecting cable and extension cord so that people will not trip over them.
- ▶ Route the connecting cable and extension cord so that they are not under tension or tangled.
- ▶ Route the connecting cable and extension cord so that they will not be damaged, kinked or crushed and will not be chafed.
- ▶ Protect the connecting cable and extension cord from heat, oil and chemicals.
- ▶ Lay the connecting cable and extension cord on a dry surface.
- The extension cable warms up in operation. If that heat cannot escape, it may cause a fire.
 - ▶ If using a cable reel: completely unroll the cable reel.
- If wiring and pipes are laid in the wall, they may be damaged if the charger is mounted on the wall. Contact with wiring can result in electric shock. This may result in serious injury to people and damage to property.
 - ▶ Make sure there is no wiring or pipes in the wall at the proposed mounting site.
- If the charger is not mounted on the wall as described in this User Manual, the charger or the battery may fall or the charger may overheat. This may result in injury to people and damage to property.
 - ▶ Mount the charger on a wall as described in this User Manual.
- If the charger is mounted on a wall with the battery inserted, the battery may fall out of the charger. This may result in injury to people and damage to property.
 - ▶ Mount the charger on the wall first before inserting the battery.

4.11 Transporting

4.11.1 Garden pruner

▲ WARNING

- The garden pruner may turn over or shift during transport. This may result in personal injuries and damage to property.



- ▶ Remove the battery.

- ▶ Fit the scabbard so that it completely covers the guide bar.
- ▶ Transport the garden pruner in the bag supplied.
- ▶ If no bag is supplied with the garden pruner: Secure the special harvester with lashing

straps or a net to prevent it turning over and moving.

4.11.2 Battery

▲ WARNING

- The battery is not protected against all ambient conditions. The battery may be damaged if it is exposed to certain ambient conditions, and damage to property may occur.
 - ▶ Never transport a damaged battery.
 - ▶ If a bag is supplied: Transport the battery in the bag supplied.
- The battery may turn over or shift during transport. This may result in injury to people and damage to property.
 - ▶ Pack the battery in packaging in such a way that it cannot move.
 - ▶ Secure the packaging so that it cannot move.

4.11.3 Charger

▲ WARNING

- The charger can turn over or move while being transported. This may result in personal injuries and damage to property.
 - ▶ Disconnect the plug from the wall outlet.
 - ▶ Remove the battery.
 - ▶ Transport the charger in the bag supplied.
 - ▶ If no bag is supplied with the charger: Secure the charger with lashing straps, belts or a net to prevent it turning over and moving.
- The connecting cable must not be used for carrying the charger. The connecting cable and the charger may be damaged.
 - ▶ Wind up the connecting cable and attach it to the charger.

4.12 Storing

4.12.1 Garden pruner

▲ WARNING

- Children are not aware of and cannot assess the dangers of the garden pruner and can be seriously injured.



- ▶ Remove the battery.

- ▶ Fit the scabbard so that it completely covers the guide bar.
- ▶ Store the garden pruner out of the reach of children.

- Dampness can corrode the electrical contacts on the garden pruner and other metal components. The garden pruner may be damaged.



- ▶ Remove the battery.

- ▶ Store the garden pruner in a clean and dry condition.

4.12.2 Battery

▲ WARNING

- Children are not aware of and cannot assess the dangers of the battery. Children may be seriously injured.
 - ▶ Store the battery out of the reach of children.
- The battery is not protected against all ambient conditions. If the battery is exposed to certain ambient conditions, the battery may be irreparably damaged.
 - ▶ Store the battery in a clean and dry condition.
 - ▶ Store the battery in an enclosed space.
 - ▶ Store the battery separately from the garden pruner.
 - ▶ If the battery is stored in the charger, disconnect the mains plug and store the rechargeable battery at a battery charge status between 40 % and 60 % (2 lit green LEDs).
 - ▶ Do not store the battery outside of the specified temperature limits, 19.7.

4.12.3 Charger

▲ WARNING

- Children are not aware of and cannot assess the dangers of a charger. Children can be seriously injured or killed.
 - ▶ Disconnect the plug from the wall outlet.
 - ▶ Store the charger out of reach of children.
- The charger is not protected against all ambient conditions. If the charger is exposed to certain ambient conditions, the charger may be damaged.
 - ▶ Disconnect the plug from the wall outlet.
 - ▶ If the charger is hot: Allow the charger to cool down.
 - ▶ Store the charger in a clean, dry place.
 - ▶ Store the charger in an enclosed room.
 - ▶ Do not store the charger outside of the specified temperature limits, 19.7.
- The connecting cable should not be used for carrying the charger or hanging up the

charger. The connecting cable and the charger may be damaged.

- ▶ Hold the charger by the housing in a secure grip.
- ▶ Hang the charger on the wall mounting.

4.13 Cleaning, Maintenance and Repair

▲ WARNING

- The garden pruner may start unintentionally if the battery is left in place during cleaning, maintenance or repair operations. There is a risk of serious injury to people and damage to property.



- ▶ Remove the battery.

- Cleaning with harsh cleaning agents, a water jet, or pointed objects can damage the garden pruner, guide bar, the saw chain, the battery and the charger. If the garden pruner, guide bar, saw chain, battery or charger are not cleaned correctly, components may no longer function properly or safety devices may be rendered inoperative. This can cause serious injury to persons.
 - ▶ Clean the garden pruner, guide bar, saw chain, battery and charger as described in this user manual.
- If the garden pruner, guide bar, saw chain, battery or charger are not properly serviced, components may no longer function properly or safety devices may be rendered inoperative. There is a risk of serious or fatal injury.
 - ▶ Do not attempt to service or repair the garden pruner, battery or charger yourself.
 - ▶ If the garden pruner, battery or the charger require servicing or repairs: Contact a STIHL servicing dealer for assistance.
 - ▶ Service or repair the guide bar and saw chain as described in this User Manual.
- The user may be cut by the sharp cutters while cleaning or servicing the saw chain. This may result in injury to the user.
 - ▶ Wear work gloves made from resistant material.

5 Preparing Garden Pruner for Operation

5.1 Preparing Garden Pruner for Operation

The following steps must be performed before commencing work:

- ▶ Ensure that the following components are in safe condition:
 - Garden pruner, [19 4.6.1.](#)
 - Guide bar, [19 4.6.2.](#)
 - Saw chain, [19 4.6.3.](#)
 - Battery, [19 4.6.4.](#)
 - Charger, [19 4.6.5.](#)
- ▶ Check the battery, [19 10.6.](#)
- ▶ Fully charge the battery, [19 6.2.](#)
- ▶ Clean the garden pruner, [19 15.1.](#)
- ▶ Mount the guide bar and saw chain, [19 7.1.1.1.](#)
- ▶ Tension the saw chain, [19 7.2.](#)
- ▶ Lubricate the saw chain, [19 7.3.](#)
- ▶ Check the controls, [19 10.5.](#)
- ▶ If you cannot carry out these steps: Do not use the garden pruner and contact your STIHL dealer for assistance.

6 Charging the Battery, LEDs

6.1 Mounting the Charger on a Wall

The charger can be mounted on a wall.

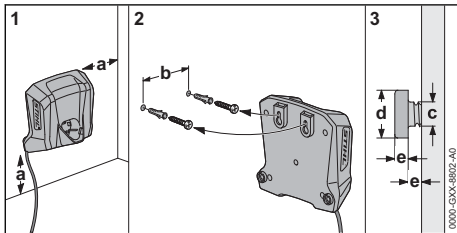

- ▶ Check the following points when mounting the charger on a wall:

- Suitable fixing materials.
 - The charger is level.
- The following dimensions are observed:
- a = at least 100 mm
 - b = 54 mm
 - c = 4.5 mm
 - d = 9 mm
 - e = 2.5 mm

6.2 Charging the battery

The charging time depends on various factors, e.g. the battery temperature or the ambient temperature. For optimum performance, observe the recommended temperature ranges, [19 19.8.](#) The actual charging time may vary from the charging time indicated. The charging time is indicated at www.stihl.com/charging-times.

The charging process starts automatically when the mains plug is plugged into a socket and the battery is inserted into the charger. The charger switches off automatically when the battery is fully charged.

The battery and the charger warm up during charging.

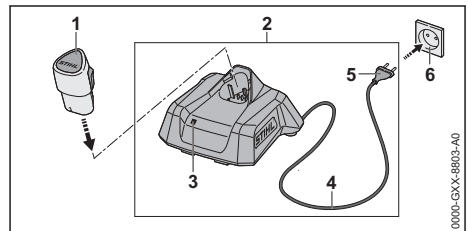

- ▶ Insert the mains plug (5) in a convenient wall outlet (6).
The charger (2) runs a self test. The LED (3) glows green for about 1 second and then red for about 1 second.
- ▶ Fit the connecting cable (4).
- ▶ Insert the battery (1) in the guides in the charger (2) and press it home as far as stop. The LED (3) glows or flashes green. The battery (2) is being charged.
- ▶ When the LED (3) stops glowing: The battery (1) is fully charged and can be taken out of the charger (2).
- ▶ If the charger (2) is no longer required. Disconnect the mains plug (5) from the wall outlet (6).

6.3 Displaying State of Charge

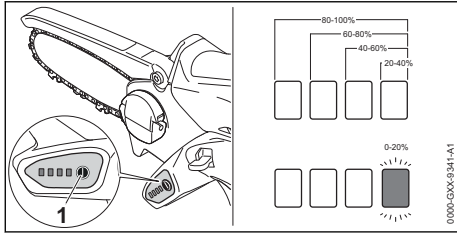

- ▶ Insert battery.
- ▶ Press the button (1).
The LEDs emit green light for about 5 seconds and indicate the state of charge.
- ▶ If the LED on the right flashes green: Charge the battery.

6.4 LEDs on Garden Pruner

The LEDs can show the state of charge or malfunctions. The LEDs can glow or flash green or red.

The state of charge is indicated when the LEDs glow or flash green.

- ▶ If the LEDs glow or flash red: Troubleshooting, [18](#).
There is a malfunction in the garden pruner or battery.

6.5 LED on Charger

The LED indicates the operating status of the charger or faults. The LED can glow or flash green or red.

If the LED glows or flashes green, the battery is being charged.

- ▶ If the LED glows or flashes red: Troubleshooting, [18](#).
There is a malfunction in charger or battery.

7 Assembling the Garden Pruner

7.1 Removing and Fitting the Bar and Chain

7.1.1 Removing the bar and chain

- ▶ Switch off the garden pruner and remove the battery.

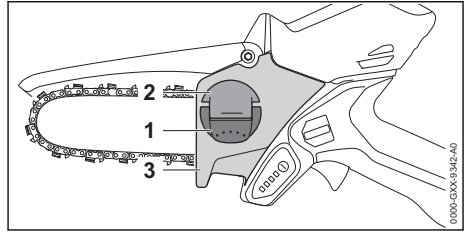

- ▶ Raise the grip (1) of the wingnut (2).
- ▶ Rotate the wingnut (2) counterclockwise until the chain sprocket cover (3) can be removed.
- ▶ Remove the chain sprocket cover (3).
- ▶ Remove the bar and chain.

7.1.2 Mounting the bar and chain

The bar and chain combinations that can be used with the chain sprocket are listed in the specifications, [20.1](#).

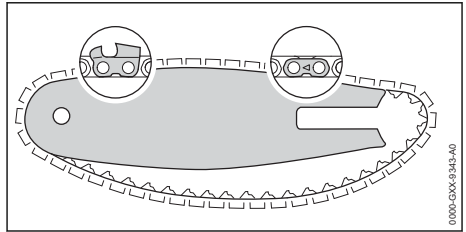

- ▶ Fit the chain in the bar groove so that the arrows on the tie straps on the top of the bar point in the direction of rotation.

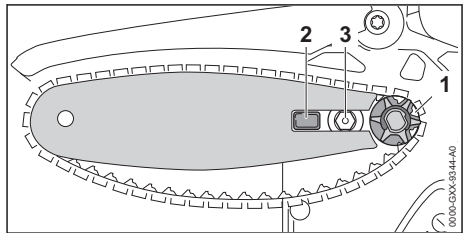

- ▶ Fit the guide bar and chain on the garden pruner and check the following points:
 - Chain drive links are seated in teeth of chain sprocket (1).
 - Peg (2) is located in guide bar's slot.
 - Collar stud (3) is located in guide bar's slot.

The guide bar may be either way round. The logo on the guide bar may also be upside down.

- ▶ Tension the chain.
- ▶ Fit the sprocket cover so that it is flush with the garden pruner.
- ▶ Rotate the wingnut clockwise until the chain sprocket cover is firmly seated.

- ▶ Fold down the grip of the wingnut.

7.2 Tensioning the Saw Chain

The saw chain expands or contracts during cutting work. Chain tension changes as a result. Check chain tension regularly during operation and readjust if necessary.

- ▶ Switch off the garden pruner and remove the battery.

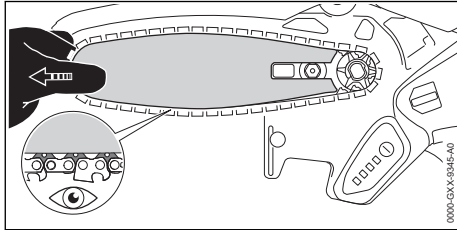

- ▶ Raise the grip of the wingnut.
- ▶ Rotate the wingnut two turns counterclockwise.

The wingnut is loose.

! WARNING

- The chain's cutters are very sharp. There is a risk of cut injuries.
 - ▶ Wear work gloves made of durable material.
- ▶ Move guide bar to the left or right until the following points apply: The drive links on the underside of the bar are still half visible.
- ▶ Rotate the wingnut clockwise until the chain sprocket cover is firmly seated.
- ▶ If the chain can still be pulled easily along the bar with two fingers: The chain is properly tensioned.
- ▶ If the drive links on the underside of the bar hang freely: Readjust chain tension.
- ▶ Fold down the grip of the wingnut.

7.3 Lubricating the Saw Chain

STIHL Multifil Bio or an equivalent biodegradable multifunctional oil lubricates and cools the rotating saw chain.

- ▶ Switch off the garden pruner and remove the battery.
- ▶ Place the garden pruner on a level surface with the sprocket cover facing up.
- ▶ Clean the guide bar and saw chain with a soft brush or STIHL resin solvent.

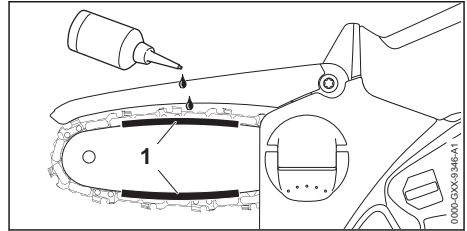

- ▶ Apply multifunctional oil in area (1) between guide bar and saw chain.
- ▶ Fit the battery.
- ▶ Switch on the garden pruner. Multifunctional oil is evenly distributed over the chain. The saw chain is lubricated.

8 Removing and Fitting the Battery

8.1 Fitting the Battery

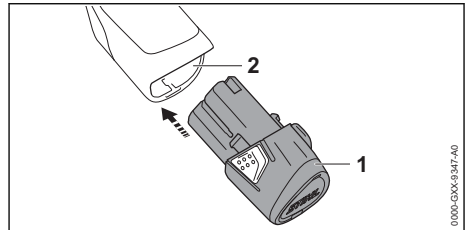

- ▶ Push the battery (1) into the battery compartment (2) as far as stop. The battery (1) engages in position with a click.

8.2 Removing the Battery

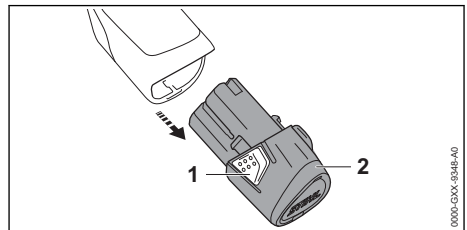

- ▶ Depress both locking hooks (1). The battery (2) is unlocked and can be removed.

9 Switching On and Off

9.1 Switching On the Garden Pruner

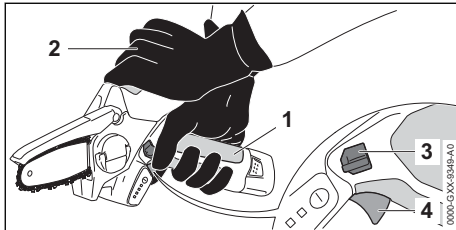

- ▶ Hold the garden pruner firmly with one hand on the grip area (1) of the control handle – wrap your thumb around the control handle.
- ▶ Hold and control the garden pruner with your other hand on the grip surface (2).
- ▶ Depress the lockout lever (3) with your thumb and hold it there.
- ▶ Pull the trigger (4) with your index finger and hold it there.
The motor accelerates and the chain rotates.
Release the lockout lever (3).

9.2 Switching Off the Garden Pruner

- ▶ Release the trigger.
The chain stops rotating.
- ▶ If the chain continues to rotate: Remove the battery and contact your STIHL dealer for assistance.
The garden pruner is defective.

10 Checking the Garden Pruner and Battery

10.1 Checking the Chain Sprocket

- ▶ Switch off the garden pruner and remove the battery.
- ▶ Remove the chain sprocket cover.
- ▶ Remove the bar and chain.

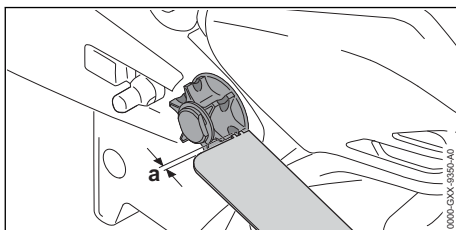



- ▶ Use a STIHL gauge to check the wear marks on the sprocket.

- ▶ If wear marks are deeper than $a = 0.5 \text{ mm}$: Do not use the garden pruner and contact your STIHL dealer for assistance.
The chain sprocket must be replaced.

10.2 Checking the Guide Bar

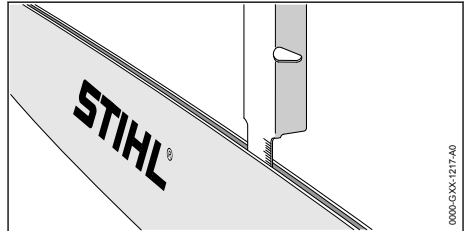
- ▶ Switch off the garden pruner and remove the battery.
- ▶ Remove the chain and guide bar.



- ▶ Measure depth of bar groove with scale on STIHL filing gauge.
- ▶ Install a new guide bar if one of the following points applies:
 - Guide bar is damaged.
 - Measured bar groove depth is less than specified minimum depth,  19.3.
 - Bar groove is pinched or splayed.
- ▶ If you have any queries: Contact a STIHL servicing dealer for assistance.

10.3 Checking the Saw Chain

- ▶ Switch off the garden pruner and remove the battery.

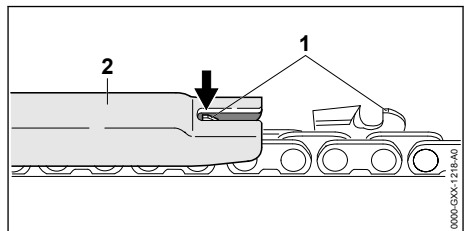

- ▶ Use a STIHL filing gauge (2) to check the height of the depth gauges (1). The STIHL filing gauge must match the chain pitch.
- ▶ If a depth gauge (1) projects from the filing gauge (2): Lower the depth gauge (1) with a file,  16.1.

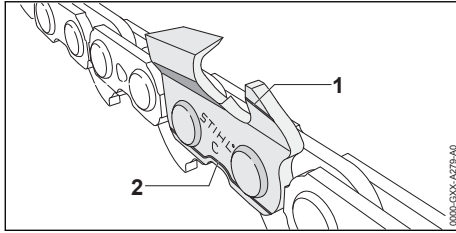

- ▶ Make sure the service marks (1 to 2) on the cutters are visible.
- ▶ If one of the service marks is not visible on a cutter: Do not use your saw chain and contact your STIHL servicing dealer for assistance.
- ▶ Use a STIHL filing gauge to check that the filing angle is 30° on all cutters. The STIHL filing gauge must match the chain pitch.
- ▶ If the filing angle of 30° has not been maintained: Resharpener the saw chain.
- ▶ If you have any queries: Contact a STIHL servicing dealer for assistance.

10.4 Checking the Chain Guard

- ▶ Remove the battery.

WARNING

- The chain's cutters are very sharp. There is a risk of cut injuries.
 - ▶ Wear work gloves made of durable material.
-
- ▶ Swing chain guard upward and let it go. Chain guard springs back to its original position.
 - ▶ If the chain guard is stiff or does not spring back to its original position: Do not use the garden pruner and contact your STIHL dealer for assistance. The chain guard is defective.

10.5 Checking the controls

Lockout lever and trigger

- ▶ Remove the battery.
- ▶ Attempt to pull the trigger without depressing the lockout lever.
- ▶ If the trigger can be pulled: Do not use your garden pruner and contact a STIHL servicing dealer. The lockout lever is faulty.
- ▶ Depress the lockout lever and hold it in that position.
- ▶ Press and release the trigger.
- ▶ If the trigger is stiff or does not spring back to its idle position: Do not use the garden pruner and contact your STIHL dealer for assistance.

The trigger has a malfunction.

Switching on the garden pruner

- ▶ Insert battery.
- ▶ Depress the lockout lever and hold it in that position.
- ▶ Press and hold the trigger. The saw chain starts running.
- ▶ If 3 LEDs flash red: Remove the battery and consult a STIHL dealer. There is a malfunction in the garden pruner.
- ▶ Release the trigger. The saw chain stops running.
- ▶ If the saw chain continues to run: Remove the battery and contact your STIHL dealer for assistance. The garden pruner has a malfunction.

10.6 Testing the Battery

- ▶ Fit the battery.
- ▶ Press button on garden pruner. The LEDs glow or flash.
- ▶ If the LEDs do not glow or flash: Do not use the garden pruner or battery and contact your STIHL dealer for assistance. There is a malfunction in the garden pruner or battery.

11 Using the Garden Pruner

11.1 Holding and Controlling the Garden Pruner

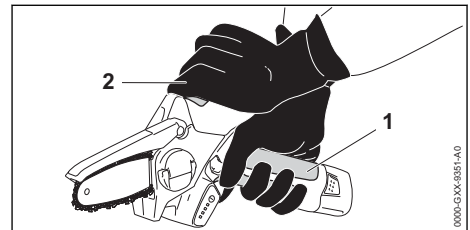

- ▶ Hold and control the garden pruner with one hand on the grip area (1) of the control handle – wrap your thumb around the control handle.
- ▶ Hold and control the garden pruner with your other hand on the grip surface (2).

11.2 Cutting

- ▶ Start cutting with the chain running at full speed.

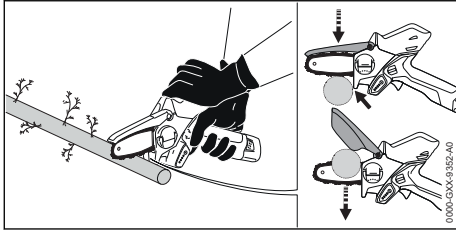

- ▶ Engage the stop and use it as a fulcrum.
- ▶ Continue cutting until guide bar is completely through the branch.
- ▶ Take the weight of the garden pruner at the end of the cut.
- ▶ Cut one branch at a time.

For optimum performance, observe the recommended temperature ranges, 19.8.

12 After Finishing Work

12.1 After Finishing Work

- ▶ Switch off the garden pruner and remove the battery.
- ▶ If the garden pruner is wet: Allow the garden pruner to dry.
- ▶ If the battery is wet or damp: Allow the battery to dry, 19.8.
- ▶ Clean the garden pruner.
- ▶ Clean the guide bar and saw chain.
- ▶ Push the chain scabbard over the guide bar so that it completely covers the guide bar.
- ▶ Clean the battery.

13 Transporting

13.1 Transporting the Garden Pruner

- ▶ Switch off the garden pruner and remove the battery.
- ▶ Fit the chain scabbard so that it completely covers the guide bar.

Carrying the Garden Pruner

- ▶ Carry the garden pruner with one hand on the control handle with the guide bar pointing down.

Transporting the Garden Pruner in a Car

- ▶ Transport the garden pruner in the bag supplied.
- ▶ Secure the bag to prevent it from tipping and moving.
- ▶ If no bag is supplied with the garden pruner: Secure the garden pruner so that it cannot tip over or move.

13.2 Transporting the Battery

- ▶ Switch off the garden pruner and remove the battery.
- ▶ Check that the battery is in a safe condition.
- ▶ Pack the battery in the bag supplied.
- ▶ If no bag is supplied with the battery: Pack the battery in packaging in such a way that it cannot move.
- ▶ Secure the packaging so that it cannot move.

The battery is subject to the Carriage of Dangerous Goods regulations. The battery is classified as UN 3480 (lithium ion batteries) and has been tested pursuant to UN Manual Tests and Criteria Part III, Subsection 38.3.

The transport regulations can be found at www.stihl.com/safety-data-sheets.

13.3 Transporting the Charger

- ▶ Disconnect the plug from the wall outlet.
- ▶ Remove the battery.
- ▶ Wind up the connecting cable and attach it to the charger.
- ▶ Transporting the charger in a vehicle:
 - ▶ Transport the charger in the bag supplied.
 - ▶ Secure the bag to prevent turnover and movement.
 - ▶ If no bag is supplied with the charger: Secure the charger to prevent turnover and movement.

14 Storing

14.1 Storing the Garden Pruner

- ▶ Switch off the garden pruner and remove the battery.
- ▶ Push the chain scabbard over the guide bar so that it completely covers the guide bar.
- ▶ Check the following points when storing the garden pruner:
 - The garden pruner cannot turn over or move.
 - The garden pruner is out of the reach of children.
 - The garden pruner is clean and dry.
 - The saw chain is lubricated.

14.2 Storing the Battery

STIHL recommends keeping the battery in a charging state between 40% and 60 % (2 green LEDs lit).

- ▶ The battery should be stored in such a way that the following conditions are fulfilled:
 - The battery is out of the reach of children.
 - The battery is clean and dry.
 - The battery is in an enclosed space.
 - Battery is stored separately from the garden pruner.
 - If the battery is stored in the charger, disconnect the mains plug and store the rechargeable battery at a battery charge status between 40 % and 60 % (2 lit green LEDs).
 - Do not store the battery outside of the specified temperature limits,  19.7.

NOTICE

- If the battery is not stored as described in this user manual, the battery may become deeply discharged and irreparably damaged.
 - ▶ Charge a discharged battery before storing it. STIHL recommends keeping the battery in a charging state between 40% and 60% (2 lit green LEDs).
 - ▶ Store the battery separately from the garden pruner.

14.3 Storing the Charger

- ▶ Disconnect the mains plug from the power supply.

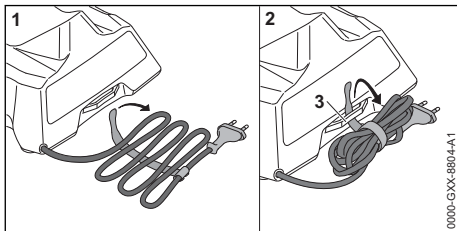

- ▶ Wind up the connecting cable and attach it to the charger.
- ▶ Observe the following points when storing the charger:
 - Charger is out of the reach of children.
 - The charger is clean and dry.
 - Charger is in an enclosed space.
 - The charger is not suspended from the connecting cable or the holder (3) for the connecting cable.
 - Do not store the charger outside of the specified temperature limits,  19.7.

15 Cleaning

15.1 Cleaning the Garden Pruner

- ▶ Switch off the garden pruner and remove the battery.
- ▶ Clean the garden pruner with a damp cloth or STIHL resin solvent.
- ▶ Clean vents with a paintbrush.
- ▶ Remove the chain sprocket cover.
- ▶ Clean the area around the chain sprocket with a damp cloth or STIHL resin solvent.
- ▶ Remove foreign objects from the battery compartment and clean the battery compartment with a damp cloth.
- ▶ Clean the electrical contacts in the battery compartment with a paintbrush or soft brush.
- ▶ Fit the chain sprocket cover.

15.2 Cleaning the Bar and Chain

- ▶ Switch off the garden pruner and remove the battery.
- ▶ Remove the bar and chain.

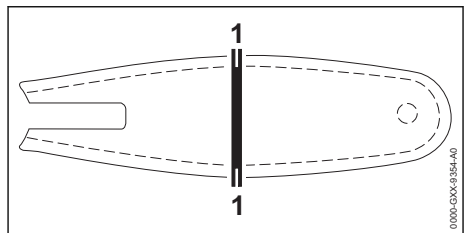

- ▶ Clean the bar groove (1) with a soft brush or STIHL resin solvent.
- ▶ Clean the saw chain with a soft brush or STIHL resin solvent.
- ▶ Mount the bar and chain.
- ▶ Lubricate the saw chain.

15.3 Cleaning the Battery

- ▶ Clean the battery with a damp cloth.

15.4 Cleaning the Charger

- ▶ Disconnect the mains plug from the power supply.
- ▶ Clean the charger with a damp cloth.
- ▶ Clean the charger's electrical contacts with a paintbrush or a soft brush.

16 Maintenance

16.1 Sharpening the Saw Chain

Correctly sharpening saw chains requires a lot of practice.

STIHL files, STIHL filing aids, STIHL sharpeners and the brochure "Sharpening STIHL Saw

Chains" help you achieve the right results. To obtain the brochure visit <http://www.stihl.com/sharpening-brochure>.

STIHL recommends you have saw chains resharpened by a STIHL servicing dealer.



WARNING

- The chain's cutters are very sharp. There is a risk of cut injuries.
 - ▶ Wear work gloves made of durable material.

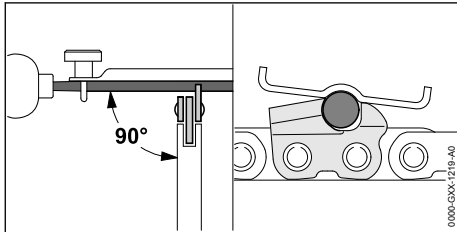

- ▶ File each cutter with a round file so that the following points are observed:
 - Round file matches the chain pitch.
 - File from the inside to the outside of the cutter.
 - Hold the file at right angle to the guide bar.
 - Maintain a filing angle of 30°.

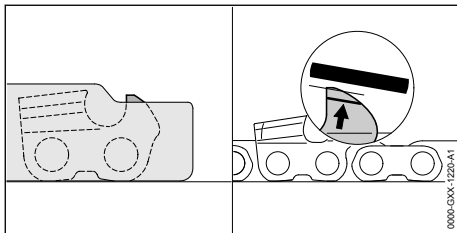

- ▶ File down the depth gauges with a flat file so that they are level with the STIHL filing gauge and parallel to the service mark. The STIHL filing gauge must match the chain pitch.
- ▶ If you have any queries: Contact your STIHL servicing dealer for assistance.

17 Repairing

17.1 Repairing the Garden Pruner, Battery and Charger



The garden pruner, guide bar, saw chain, battery and charger are not user serviceable.

- ▶ If the garden pruner, guide bar or saw chain are damaged: Do not use your garden pruner, guide bar or saw chain, and contact your STIHL servicing dealer for assistance.
- ▶ If the battery has a malfunction or is damaged: Replace the battery.
- ▶ If the charger has a malfunction or is damaged: Replace the charger.
- ▶ If the connecting cable has a malfunction or is damaged: Do not use the charger and have connecting cable replaced by a STIHL servicing dealer.

18 Troubleshooting

18.1 Troubleshooting the Garden Pruner or Battery

Fault	LEDs on garden pruner	Cause	Remedy
Garden pruner does not run when switched on.	1 LED flashes green.	State of charge of the battery is too low.	▶ Charge the battery.
	1 LED emits red light.	The battery is too warm or too cold.	▶ Remove the battery. ▶ Allow the battery to cool down or warm up.
	3 LEDs flash red.	There is a malfunction in the garden pruner.	▶ Remove battery and reinsert it. ▶ Switching on the garden pruner

Fault	LEDs on garden pruner	Cause	Remedy
			<ul style="list-style-type: none"> ▶ If 3 LEDs continue to flash red: Do not use the garden pruner and contact your STIHL dealer for assistance.
	3 LEDs light up red.	Garden pruner is too hot.	<ul style="list-style-type: none"> ▶ Remove the battery. ▶ Allow garden pruner to cool down.
	4 LEDs flash red.	There is a fault in the battery.	<ul style="list-style-type: none"> ▶ Remove the battery. ▶ Clean electrical contacts in the battery compartment. ▶ Insert battery. ▶ Switching on the garden pruner ▶ If 4 LEDs continue to flash red: Do not use the battery; contact a STIHL authorized dealer.
		No electrical contact between garden pruner and battery.	<ul style="list-style-type: none"> ▶ Remove the battery. ▶ Clean electrical contacts in the battery compartment. ▶ Insert battery.
		Garden pruner or battery damp.	<ul style="list-style-type: none"> ▶ Allow the garden pruner or battery to dry,  19.8.
		The saw chain is jammed.	<ul style="list-style-type: none"> ▶ Remove the battery. ▶ Clean the garden pruner,  15.1.
Garden pruner cuts out during operation.	3 LEDs light up red.	Garden pruner is too hot.	<ul style="list-style-type: none"> ▶ Remove the battery. ▶ Allow garden pruner to cool down.
		There is an electrical fault.	<ul style="list-style-type: none"> ▶ Remove battery and reinsert it. ▶ Switching on the garden pruner
Cutting performance of garden pruner deteriorates.	1 LED flashes green.	State of charge of the battery is too low.	<ul style="list-style-type: none"> ▶ Charge the battery.
		The saw chain has not been correctly sharpened.	<ul style="list-style-type: none"> ▶ Sharpen chain as specified.
		The saw chain is over-tensioned.	<ul style="list-style-type: none"> ▶ Tension the saw chain as specified.
		Insufficient chain lubrication.	<ul style="list-style-type: none"> ▶ Lubricate the saw chain.
Garden pruner runtime is too short.		The battery is not fully charged.	<ul style="list-style-type: none"> ▶ Fully charge the battery.
		The battery service life has been exceeded.	<ul style="list-style-type: none"> ▶ Replace the battery.

18.2 Troubleshooting the Charger

Fault	LED on Charger	Cause	Remedy
Battery not being charged.	One LED glows red.	The battery is too warm or too cold.	<ul style="list-style-type: none"> ▶ Leave battery inserted in charger. Charging starts automatically as soon as the permitted temperature range is reached.
	The LED flashes red.	No electrical contact between charger and battery.	<ul style="list-style-type: none"> ▶ Remove the battery. ▶ Clean contacts on charger. ▶ Insert battery.

Fault	LED on Charger	Cause	Remedy
		There is a malfunction in the charger.	▶ Do not use the charger and contact your STIHL dealer for assistance.
		There is a fault in the battery.	▶ Do not use the battery. Consult a STIHL dealer.
The charger does not run a self test.	The LED glows green for about 1 second and then red for about 1 second.	Electrical contact to charger was briefly interrupted.	<ul style="list-style-type: none"> ▶ Disconnect the mains plug from the power supply. ▶ Wait for 1 minute. ▶ Insert the mains plug in a wall outlet.

19 Specifications

19.1 STIHL GTA 26 Garden Pruner

- Approved battery: STIHL AS
- Weight without battery, guide bar and saw chain 1.2 kg

For battery life see www.stihl.com/battery-life.

19.2 Chain Sprockets

The following chain sprockets may be used:

- 6-tooth for 1/4" P
 - Maximum chain speed: 8.0 m/s

19.3 Minimum groove depth of guide bars

The minimum groove depth depends on the pitch of the guide bar.

- 1/4" P 4 mm

19.4 STIHL AS Battery

- Battery Technology: Lithium-ion
- Voltage: 10.8 V
- Capacity in Ah: see rating label
- Energy content in Wh: see rating label
- Weight in kg: see rating label

19.5 STIHL AL 1 Charger

- Rated voltage: see rating plate
- Frequency: see rating plate
- Rated power: see rating plate
- Charging current: see rating plate
- Maximum energy content of approved STIHL AS battery: 12.5 Ah

For charging times see www.stihl.com/charging-times.

19.6 Extension Cords

If an extension cord is used, the cross sectional area of its conductors must meet the following minimum requirements – depending on the line voltage and length of the extension cord:

If rated voltage on the rating label is 220V to 240V:

- Cord length up to 20 m: AWG 15 / 1.5 mm²
- Cord length 20 m up to 50 m: AWG 13 / 2.5 mm²

If rated voltage on the rating label is 100V to 127V:

- Cord length up to 10 m: AWG 14 / 2.0 mm²
- Cord length 10 m up to 30 m: AWG 12 / 3.5 mm²

19.7 Temperature limits



WARNING

- The battery is not protected against all ambient conditions. If the battery is exposed to certain ambient conditions, it may catch fire or explode. There is a risk of serious injury to people and damage to property.
 - ▶ Do not charge the battery below -20°C or above +50°C.
 - ▶ Do not use the garden pruner, battery or charger below -20 °C or above +50 °C.
 - ▶ Do not store the garden pruner, battery or charger below -20 °C or above +70 °C.

19.8 Recommended temperature ranges

For optimum performance of the garden pruner, batteries and charger, observe the following temperature ranges:

- Charging: 5°C to 40°C
- Use: - 10 °C to + 40 °C
- Storage: - 20 °C to + 50 °C

If the battery is charged, used or stored outside the recommended temperature ranges, performance may be reduced.

If the battery is wet or damp, allow the battery to dry for at least 48 h between 15°C and 50°C and

with less than 70% humidity. Higher humidity may extend the drying time.

19.9 Sound Values and Vibration Values

K-value (uncertainty) for sound pressure levels is 2 dB(A). K-value (uncertainty) for sound power levels is 2 dB(A). K-value for vibration level is 2 m/s².

STIHL recommends wearing ear defenders.

- Sound pressure level L_{pA} measured according to EN 60745-2-13: 77 dB(A)
- Sound power level L_{WA} measured according to EN 60745-2-13: 86 dB(A)
- Vibration level a_{hv} measured according to EN 60745-2-13:
 - Control handle: 2.8 m/s²
 - Grip surface: 2.9 m/s.

The vibration levels indicated were measured according to a standardized test method and can

be used as a basis for comparing electric power tools. The vibration levels actually occurring may vary from the values indicated, depending on the type of application. The vibration levels indicated can be used for an initial estimate of the vibration stress. The actual vibration stress has to be estimated. The times when the power tool is switched off and the times when it is switched on but running under no load can be taken into account in the estimate.

For information on compliance with Employers' Vibration Directive 2002/44/EC see www.stihl.com/vib.

19.10 REACH

REACH is an EC regulation and stands for the Registration, Evaluation, Authorisation and Restriction of Chemical substances.

For information on compliance with the REACH regulation see www.stihl.com/reach.

20 Bar and Chain Combinations

20.1 STIHL GTA 26 Garden Pruner

Pitch	Drive link gauge/groove width	Length	Guide bar	Nose sprocket teeth	Number of drive links	Saw chain
1/4" P	1.1 mm	10 cm	Light	–	28	71 PM3 (Type 3670)

The cutting length of a guide bar depends on the garden pruner model being used and the saw chain. Actual cutting length may be less than the specified length

21 Spare Parts and Accessories

21.1 Spare parts and accessories

STIHL  These symbols indicate original STIHL spare parts and original STIHL accessories.

STIHL recommends the use of original STIHL spare parts and accessories.

Despite ongoing market observation, STIHL is unable to judge the reliability, safety and suitability of other manufacturers' spare parts and accessories; accordingly, STIHL cannot warrant for the use of those parts.

Original STIHL spare parts and original STIHL accessories are available from STIHL dealers.

22 Disposal

22.1 Disposing of Garden Pruner, Battery and Charger

Contact the local authorities or your STIHL dealer for information on disposal.

Improper disposal can be harmful to health and pollute the environment.

- ▶ Take STIHL products including packaging to a suitable collection point for recycling in accordance with local regulations.
- ▶ Do not dispose with domestic waste.

23 EC Declaration of Conformity

23.1 STIHL GTA 26 Cordless Pruner

ANDREAS STIHL AG & Co. KG
Badstraße 115

D-71336 Waiblingen

Germany

declare under our sole responsibility that

- type: cordless garden pruner
- Manufacturer's brand: STIHL
- series: GTA 26
- Serial number: GA01
- Accessories: GTA 26 Extension (GA01 820 5000)

conforms to the relevant provisions of Directives 2011/65/EU, 2006/42/EC, 2014/30/EU and 2000/14/EC and has been developed and manufactured in compliance with the following standards in the versions valid on the date of production: EN 55014-1, EN 55014-2 and EN 62841-1.

The EC type examination test was carried out pursuant to Directive 2006/42/EC, Art. 12.3(b) at: VDE Prüf- u. Zertifizierungsinstitut (NB 0366), Merianstraße 28, 63069 Offenbach, Germany
– Certification number: 40050017

The measured and guaranteed equivalent sound power level has been determined in accordance with Directive 2000/14/EC, Annex V.

- Measured sound power level: 88 dB(A)
- Guaranteed sound power level: 90 dB(A)

The technical documents are stored at ANDREAS STIHL AG & Co. KG Produktzulassung.

The year of manufacture, country of manufacture and serial number are indicated on the garden pruner.

Waiblingen, 2023-06-15

ANDREAS STIHL AG & Co. KG

pp 

Robert Olma, Vice President, Regulatory Affairs & Global Governmental Relations

24 UKCA Declaration of Conformity

24.1 STIHL GTA 26 Cordless Pruner



ANDREAS STIHL AG & Co. KG

Badstraße 115

D-71336 Waiblingen

Germany

declare under our sole responsibility that

- type: cordless garden pruner
- Manufacturer's brand: STIHL
- series: GTA 26
- Serial number: GA01
- Accessories: GTA 26 Extension (GA01 820 5000)

conforms to the relevant provisions of UK regulations The Restriction of the Use of Certain Hazardous Substances in Electrical and Electronic Equipment Regulations 2012, Supply of Machinery (Safety) Regulations 2008, Electromagnetic Compatibility Regulations 2016 and Noise Emission in the Environment by Equipment for use Outdoors Regulations 2001 and has been manufactured in compliance with the following standards in the versions valid on the date of production: EN 55014-1, EN 55014-2, and EN 62841-1.

The type examination was carried out by: Inter-tek Testing & Certification Ltd, Academy Place, 1-9 Brook Street, Brentwood, Essex, CM14 5NQ, United Kingdom
– Certification number: UK-MCR-0043

The measured and guaranteed sound power levels have been determined in accordance with UK regulations Noise Emission in the Environment by Equipment for use Outdoors Regulations 2001, Schedule 8.

- Measured sound power level: 88 dB(A)
- Guaranteed sound power level: 90 dB(A)

The technical documents are stored at ANDREAS STIHL AG & Co. KG.

The year of manufacture, country of manufacture and serial number are indicated on the garden pruner.

Waiblingen, 15.06.2023

ANDREAS STIHL AG & Co. KG

pp 

Robert Olma, Vice President, Regulatory Affairs & Global Governmental Relations

25 Addresses

www.stihl.com

26 General Power Tool Safety Warnings

26.1 Introduction

This chapter reproduces the pre-formulated, general safety precautions specified in the IEC 62841 standard for hand-held motor-operated electric tools.

STIHL is obliged to publish these texts.

The safety precautions and warnings on avoiding an electric shock given under "Electrical Safety" do not apply to STIHL cordless products.

WARNING

- **Read all safety warnings, instructions, illustrations and specifications provided with this power tool.** Failure to follow all instructions listed below may result in electric shock, fire and/or serious injury. **Save all warnings and instructions for future reference.**

The term "electric power tool" in the safety warnings refers to mains-operated (corded) power tools or battery-operated (cordless) power tools.

26.2 Work area safety

- a) **Keep work area clean and well lit.** Cluttered or dark areas invite accidents.
- b) **Do not operate power tools in explosive atmospheres, such as in the presence of flammable liquids, gases or dust.** Power tools create sparks which may ignite the dust or fumes.
- c) **Keep children and bystanders away while operating a power tool.** Distractions can cause you to lose control.

26.3 Electrical safety

- a) **Power tool plugs must match the outlet. Never modify the plug in any way. Do not use any adapter plugs with earthed (grounded) power tools.** Unmodified plugs and matching outlets will reduce risk of electric shock.
- b) **Avoid body contact with earthed or grounded surfaces, such as pipes, radiators, ranges and refrigerators.** There is an increased risk of electric shock if your body is earthed or grounded.
- c) **Do not expose power tools to rain or wet conditions.** Water entering a power tool will increase the risk of electric shock.

- d) **Do not abuse the cord. Never use the cord for carrying, pulling or unplugging the power tool. Keep cord away from heat, oil, sharp edges or moving parts.** Damaged or entangled cords increase the risk of electric shock.
- e) **When operating a power tool outdoors, use an extension cord suitable for outdoor use.** Use of a cord suitable for outdoor use reduces the risk of electric shock.
- f) **If operating a power tool in a damp location is unavoidable, use a residual current device (RCD) protected supply.** Use of an RCD reduces the risk of electric shock.

26.4 Personal safety

- a) **Stay alert, watch what you are doing and use common sense when operating a power tool. Do not use a power tool while you are tired or under the influence of drugs, alcohol or medication.** A moment of inattention while operating power tools may result in serious personal injury.
- b) **Use personal protective equipment. Always wear eye protection.** Protective equipment such as a dust mask, non-skid safety shoes, hard hat or hearing protection used for appropriate conditions will reduce personal injuries.
- c) **Prevent unintentional starting. Ensure the switch is in the off-position before connecting to power source and/or battery pack, picking up or carrying the tool.** Carrying power tools with your finger on the switch or energising power tools that have the switch on invites accidents.
- d) **Remove any adjusting key or wrench before turning the power tool on.** A wrench or a key left attached to a rotating part of the power tool may result in personal injury.
- e) **Do not overreach. Keep proper footing and balance at all times.** This enables better control of the power tool in unexpected situations.
- f) **Dress properly. Do not wear loose clothing or jewellery. Keep your hair and clothing away from moving parts.** Loose clothes, jewellery or long hair can be caught in moving parts.
- g) **If devices are provided for the connection of dust extraction and collection facilities, ensure these are connected and properly used.** Use of dust collection can reduce dust-related hazards.

- h) **Do not let familiarity gained from frequent use of tools allow you to become complacent and ignore tool safety principles.** A careless action can cause severe injury within a fraction of a second.

26.5 Power tool use and care

- a) **Do not force the power tool. Use the correct power tool for your application.** The correct power tool will do the job better and safer at the rate for which it was designed.
- b) **Do not use the power tool if the switch does not turn it on and off.** Any power tool that cannot be controlled with the switch is dangerous and must be repaired.
- c) **Disconnect the plug from the power source and/or remove the battery pack, if detachable, from the power tool before making any adjustments, changing accessories, or storing power tools.** Such preventive safety measures reduce the risk of starting the power tool accidentally.
- d) **Store idle power tools out of the reach of children and do not allow persons unfamiliar with the power tool or these instructions to operate the power tool.** Power tools are dangerous in the hands of untrained users.
- e) **Maintain power tools and accessories. Check for misalignment or binding of moving parts, breakage of parts and any other condition that may affect the power tool's operation. If damaged, have the power tool repaired before use.** Many accidents are caused by poorly maintained power tools.
- f) **Keep cutting tools sharp and clean.** Properly maintained cutting tools with sharp cutting edges are less likely to bind and are easier to control.
- g) **Use the power tool, accessories and tool bits etc. in accordance with these instructions, taking into account the working conditions and the work to be performed.** Use of the power tool for operations different from those intended could result in a hazardous situation.
- h) **Keep handles and grasping surfaces dry, clean and free from oil and grease.** Slippery handles and grasping surfaces do not allow for safe handling and control of the tool in unexpected situations.

26.6 Battery tool use and care

- a) **Recharge only with the charger specified by the manufacturer.** A charger that is suitable for one type of battery pack may create a risk of fire when used with another battery pack.
- b) **Use power tools only with specifically designed battery packs.** Use of any other battery packs may create a risk of injury and fire.
- c) **When battery pack is not in use, keep it away from other metal objects, like paper clips, coins, keys, nails, screws or other small metal objects, that can make a connection from one terminal to another.** Shorting the battery terminals together may cause burns or a fire.
- d) **Under abusive conditions, liquid may be ejected from the battery; avoid contact. If contact accidentally occurs, flush with water. If liquid contacts eyes, additionally seek medical help.** Liquid ejected from the battery may cause irritation or burns.
- e) **Do not use a battery pack or tool that is damaged or modified.** Damaged or modified batteries may exhibit unpredictable behaviour resulting in fire, explosion or risk of injury.
- f) **Do not expose a battery pack or tool to fire or excessive temperature.** Exposure to fire or temperature above 130 °C may cause explosion.
- g) **Follow all charging instructions and do not charge the battery pack or tool outside the temperature range specified in the instructions.** Charging improperly or at temperatures outside the specified range may damage the battery and increase the risk of fire.

26.7 Service

- a) **Have your power tool serviced by a qualified repair person using only identical replacement parts.** This will ensure that the safety of the power tool is maintained.
- b) **Never service damaged battery packs.** Service of battery packs should only be performed by the manufacturer or authorized service providers.

26.8 Garden Pruner Safety Warnings

General Garden Pruner Safety Warnings

- a) **Keep all parts of your body away from the saw chain when the garden pruner is operating. Before you start the garden pruner,**

- make sure the saw chain does not touch anything.** A moment of inattention while operating garden pruner may cause entanglement of your clothing or body with the saw chain.
- b) **Always hold the garden pruner with one hand on the rear handle and the other hand on the auxiliary handle.**
 - c) **Hold the garden pruner by insulated gripping surfaces only, because the saw chain may contact hidden wiring or its own cord.** Saw chains contacting a "live" wire may make exposed metal parts of the garden pruner "live" and could give the operator an electric shock.
 - d) **Wear eye protection. Further protective equipment for hearing, head, hands, legs and feet is recommended.** Adequate protective equipment will reduce personal injury from flying debris or accidental contact with the saw chain.
 - e) **Do not operate a garden pruner on a ladder, from a rooftop, or any unstable support.** Operation of a garden pruner in this manner could result in serious personal injury.
 - f) **Always keep proper footing and operate the garden pruner only when standing on a fixed, secure and level surface.** Slippery or unstable surfaces may cause a loss of balance or control of the garden pruner.
 - g) **When cutting a limb that is under tension be alert for spring back.** When the tension in the wood fibers is released the spring loaded limb may strike the operator and/or throw the garden pruner out of control.
 - h) **Use extreme caution when cutting brush and saplings.** The slender material may catch the saw chain and be whipped toward you or pull you off balance.
 - i) **Carry the garden pruner with the garden pruner switched off and away from your body. When transporting or storing the garden pruner, always fit the guide bar cover.** Proper handling of the garden pruner will reduce the likelihood of accidental contact with the moving saw chain.
 - j) **Follow the instructions for lubricating, chain tensioning and changing the bar and chain.** Improperly tensioned or lubricated garden pruner may either break or increase the chance for kickback.
- k) **Cut wood only. Do not use garden pruner for purposes not intended. For example: do not use garden pruner for cutting metal, plastic, masonry or non-wood building materials.** Use of the garden pruner for operations different than intended could result in a hazardous situation.
 - l) **This garden pruner is not intended for tree felling.** Use of the garden pruner for operations different than intended could result in serious injury to the operator or bystanders.
 - m) **Follow all instructions when clearing jammed material, storing or servicing the garden pruner. Make sure the switch is off and the battery pack is removed.** Unexpected actuation of the garden pruner while clearing jammed material or servicing may result in serious personal injury.

26.9 Causes and operator prevention of kickback

Kickback may occur when the nose or tip of the guide bar touches an object or when the wood closes in and pinches the saw chain in the cut.

Tip contact in some cases may cause a sudden reverse reaction, kicking the guide bar up and back towards the operator.

Pinching the saw chain along the top of the guide bar may push the bar rapidly back towards the operator.

Either of these reactions may cause you to lose control of the garden pruner which could result in serious personal injury. Do not rely exclusively upon the safety devices built into your garden pruner. As a garden pruner user, you should take several steps to keep your cutting jobs free from accident or injury.

Kickback is the result of garden pruner misuse and/or incorrect operating procedures or conditions and can be avoided by taking proper precautions as given below:

- a) **Maintain a firm grip, with thumbs and fingers encircling the garden pruner handles, with both hands on the garden pruner and position your body and arm to allow you to resist kickback forces.** Kickback forces can be controlled by the operator if proper precautions are taken. Do not let go of the garden pruner.
- b) **Do not overreach and do not cut above shoulder height, unless the extension shaft is correctly mounted.** This helps prevent unintended tip contact and enables better control

of the garden pruner in unexpected situations.

- c) **Only use replacement guide bars and chains specified by the manufacturer.** Incorrect replacement guide bars and saw chains may cause chain breakage and/or kickback.
- d) **Follow the manufacturer's sharpening and maintenance instructions for the saw chain.** Decreasing the depth gauges height can lead to increased kickback.

www.stihl.com



0458-694-0121-C



0458-694-0121-C