

STIHL

STIHL MS 201 TC-M

Instruction Manual



Contents

Guide to Using this Manual	2	Maintenance and Repairs	37
Safety Precautions	3	Disposal	38
Reactive Forces	9	EC Declaration of Conformity	38
Working Techniques	10		
Cutting Attachment	12		
Mounting the Bar and Chain	12		
Tensioning the Saw Chain (side chain tensioner)	13		
Checking Chain Tension	14		
Fuel	14		
Fueling	15		
Chain Lubricant	17		
Filling Chain Oil Tank	17		
Checking Chain Lubrication	18		
Chain Brake	18		
Winter Operation	19		
Starting / Stopping the Engine	19		
Operating Instructions	22		
Oil Quantity Control	23		
Taking Care of the Guide Bar	23		
Cleaning the Air Filter	24		
M-Tronic	24		
Spark Plug	25		
Storing the Machine	27		
Checking the Chain Sprocket	27		
Maintaining and Sharpening the Saw Chain	28		
Maintenance and Care	32		
Minimize Wear and Avoid Damage	34		
Main Parts	35		
Specifications	36		
Ordering Spare Parts	37		

Dear Customer,

Thank you for choosing a quality engineered STIHL product.

It has been built using modern production techniques and comprehensive quality assurance. Every effort has been made to ensure your satisfaction and trouble-free use of the product.

Please contact your dealer or our sales company if you have any queries concerning this product.

Your



Dr. Nikolas Stihl

STIHL

This instruction manual is protected by copyright. All rights reserved, especially the rights to reproduce, translate and process with electronic systems.

Guide to Using this Manual

This Instruction Manual refers to a STIHL chain saw, also called a machine in this Instruction Manual.

Pictograms

Pictograms that appear on the machine are explained in this Instruction Manual.

Depending on the machine and equipment version, the following pictograms may appear on the machine.



Fuel tank; fuel mixture of gasoline and engine oil



Tank for chain oil; chain oil



Engage and release chain brake



Coasting brake



Direction of chain travel



Ematic; chain oil flow adjustment



Tension saw chain



Intake air baffle: winter operation



Intake air baffle: summer operation



Handle heating

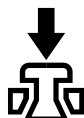

Actuate decompression valve

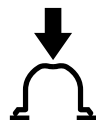

Actuate manual fuel pump

Symbols in text



WARNING

Warning where there is a risk of an accident or personal injury or serious damage to property.



NOTICE

Caution where there is a risk of damaging the machine or its individual components.

Engineering improvements

STIHL's philosophy is to continually improve all of its products. For this reason we may modify the design, engineering and appearance of our products periodically.

Therefore, some changes, modifications and improvements may not be covered in this manual.

Safety Precautions



This **special chain saw** shall be used only by persons who are trained in special cutting and working techniques.



Due to the special **handle design** (closely spaced handles) there is an **increased risk of injury** using this kind of saw (cut injuries due to uncontrolled reactive forces of the chain saw). Special safety precautions must be observed to reduce the risk of personal injury when working with a chainsaw because of the very high chain speed and very sharp cutters.



It is important that you read the instruction manual before first use and keep it in a safe place for future reference. Non-observance of the instruction manual may result in serious or even fatal injury.

General

Observe all applicable local safety regulations, standards and ordinances.

The use of noise emitting power tools may be restricted to certain times by national or local regulations.

If you have not used this model before: Have your dealer or other experienced user show you how to operate your machine or attend a special course in its operation.

Minors should never be allowed to use a chainsaw. Exceptions to this rule are young persons older than 16 who have been trained in special cutting techniques with the tree surgery saw.

Keep bystanders, especially children, and animals away from the work area.

The user is responsible for avoiding injury to third parties or damage to their property.

Do not lend or rent your chain saw without the instruction manual. All users must be specially trained in tree surgery work with a tree surgery saw and be familiar with this model and its operation.

To operate a chain saw you must be rested, in good physical condition and mental health. If you have any condition that might be aggravated by strenuous work, check with your doctor before operating a chainsaw.

Do not operate the chain saw if you are under the influence of any substance (drugs, alcohol) which might impair vision, dexterity or judgment.

To reduce the risk of accidents or injury, put off the work in poor weather conditions (rain, snow, ice, wind).

Persons with pacemakers only: The ignition system of your chainsaw produces an electromagnetic field of a very low intensity. This field may

interfere with some pacemakers. To reduce health risks, STIHL recommends that persons with pacemakers consult their physician and the pacemaker manufacturer before operating this power tool.

Intended Use

Tree surgery chainsaws are special-purpose saws equipped with a top handle. They are designed specifically for tree surgery and maintenance in the crown of the standing tree.

Chainsaw operators must be properly secured while working in a tree (e.g. lift bucket, personal safety equipment, safety harness).

The chainsaw may be used for cutting wood and wooden objects only.

It must not be used for any other purpose because of the increased risk of accidents.

They must not be used for felling trees or cutting firewood. Normal chainsaws with wider spaced handles are recommended for such operations.

Never attempt to modify your saw in any way since this may increase the risk of personal injury. STIHL excludes all liability for personal injury and damage to property caused while using unauthorized attachments.

Clothing and Equipment

Wear proper protective clothing and equipment.



Clothing must be sturdy and snug-fitting, but allow complete freedom of movement. Wear snug-fitting clothing with **cut-retardant pads** for feet, legs, hands and forearms – an overall, not a loose-fitting jacket.

Avoid clothing that could get caught on branches, brush or moving parts of the machine. Do not wear a scarf, necktie or jewelry. Tie up and confine long hair (headscarf, cap, hard hat, etc.).



Wear suitable **safety shoes** – with cut-retardant material, non-slip soles and steel toe caps.

WARNING



To reduce the risk of eye injuries, wear tight-fitting safety goggles conforming to standard EN 166. Make sure that the safety goggles fit correctly.

Wear a face shield and make sure it fits correctly.

Wear "personal" hearing protection – for example, ear defenders.

Wear a hard hat with a chin strap wherever there is any risk of falling objects.



Wear sturdy protective gloves made of a resistant material (e.g. leather) – with cut-retardant material.

STIHL can supply a comprehensive range of personal protective clothing and equipment.

Use a personal fall arrest system.

Use only certified equipment that is suitable for the application concerned.

Check the condition of the equipment before use and replace broken parts.

Transporting

Always stop the engine, engage the chain brake and fit the chain guard (scabbard) before carrying the saw short distances. This avoids the risk of the chain running unintentionally.

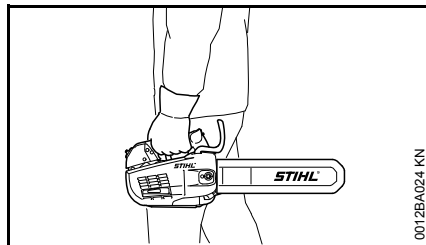

Always carry the saw by the control handle – with the hot muffler away from your body – the guide bar must point to the rear. To reduce the risk of serious burn injuries, avoid touching hot parts of the machine, especially the surface of the muffler.

In vehicles: Properly secure your saw to prevent turnover, fuel spillage and damage.

Cleaning

Clean plastic parts with a cloth. Harsh detergents can damage the plastic.

Clean the dust and dirt off the machine – do not use any grease solvents for this purpose.

Clean the ventilation slots if necessary.

Do not use a high-pressure cleaner to clean the machine. The hard jet of water can damage parts of the machine.

Accessories

Only use those tools, guide bars, chains, chain sprockets, accessories or technically equivalent components that have been approved by STIHL for this machine. If you have any questions in this respect, consult a servicing dealer. Use only high quality tools and accessories. Otherwise, there may be a risk of accidents and damage to the machine.

STIHL recommends the use of genuine STIHL tools, guide bars, chains, chain sprockets and accessories. They are specifically designed to match your model and meet your performance requirements.

Refuelling



Gasoline is an extremely flammable fuel – keep clear of naked flames and fire – do not spill any fuel – no smoking.

Switch off the engine before refuelling.

Never refuel the machine while the engine is still hot – the fuel may spill over – **risk of fire!**

Open the fuel filler cap carefully so that any excess pressure is relieved gradually and fuel does not splash out.

The machine may only be refuelled in a well ventilated place. Clean the machine immediately if fuel is spilled. Do not spill fuel over your clothing – contaminated clothing must be changed immediately.

The machines can be equipped with the following filler caps as standard:

Cliplock filler cap (bayonet-type)



Place the cliplock filler cap (bayonet-type) in position, turn as far as stop and fold the cliplock down.

This helps reduce the risk of unit vibrations causing an incorrectly tightened filler cap to loosen or come off and spill quantities of fuel.



Look out for leaks! Never start the engine if fuel has been spilled or is leaking – **Fatal burns may result!**

Before Starting Work

Check that your saw is properly assembled and in good condition – refer to appropriate chapters in the instruction manual.

- Check the fuel system for leaks, paying special attention to visible parts such as the tank cap, hose connections and the manual fuel pump (on machines so equipped). If

there are any leaks or damage, do not start the engine – **risk of fire**. Have your saw repaired by a servicing dealer before using it again.

- Check operation of chain brake, front hand guard
- Correctly mounted guide bar
- Correctly tensioned chain
- The trigger and trigger lockout must move freely and spring back to the idle position when they are released.
- Master Control lever must move easily to **STOP, 0** or 
- Check that the spark plug boot is secure – a loose boot may cause arcing that could ignite combustible fumes **and cause a fire**.
- Never attempt to modify the controls or safety devices in any way.
- Keep the handles dry and clean – free from oil and dirt – for safe control of the saw.
- Make sure there is sufficient fuel and chain oil in the tanks.

To reduce the risk of personal injury, do not operate your saw if it is damaged or not properly assembled.

Starting the Saw

Start the saw on level ground only. Make sure you have a firm footing. Hold the saw firmly. To reduce the risk of injury from the rotating chain, check that the cutting attachment is not touching any object or the ground .

The chainsaw is a one-person saw. Do not allow other persons in the work area – even when starting.

Do not attempt to start the saw when the saw chain is in a cut.

Starting the saw in a tree is very dangerous since the user may lose control of the machine – **risk of injury**.

The tree surgery saw should be checked, fueled, started and warmed up by an assistant on the ground before it is transported up to the operator in the tree.

Start the engine at least 3 meters from the fueling spot, outdoors only.

To reduce risk of chain rotation and personal injury, lock the chain with the chain brake before starting.

Do not drop start the power tool – start the engine as described in the instruction manual.

During Operation

When working in the tree, always secure the chainsaw with a rope – tie it to the ring and attach it to the lifeline. Always engage the chain brake before letting the chainsaw hang by the rope.

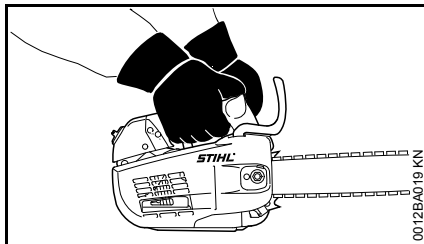

To reduce the risk of accidents and injuries, always hold your saw firmly with both hands:

Right hand on the control handle, even if you are left-handed. To ensure safe control, wrap your fingers tightly around both handles.



One-handed operation is particularly dangerous, e.g. when cutting dry, knotty and dead wood, the chain may not enter the cut properly. The resultant reactive forces may cause the saw to skate or bounce on the limb and slide out of control. **This increases the risk of serious or even fatal injury.**



Use the tree surgery chainsaw with one hand only:

- if two-handed cutting is not possible and
- if one hand is required for support during the cut and

- if the saw is held firmly and
- if all parts of your body are clear of the cutting attachment.

During one-handed cutting:

- never support yourself on the limb being cut
- never cut with the bar nose
- never attempt to hold falling limbs

Make sure you always have good balance and secure footing. **To avoid slipping**, take special care when the bark is wet.

In the event of impending danger or in an emergency, switch off the engine immediately – move the Master Control lever in the direction of **STOP, 0** or **0**.

Never leave a running saw unattended.

Take special care in slippery conditions – damp, snow, ice, on slopes, uneven ground and freshly debarked logs.

Watch out for obstacles such as tree stumps, roots and ditches which could cause you to trip or stumble.

Do not work alone – keep within calling distance of other persons trained in first aid who can provide assistance in an emergency. Helpers at the cutting site must also wear protective clothing (hard hat) and stand well clear of the branches being cut.

Be particularly alert and cautious when wearing hearing protection because your ability to hear warnings (shouts, alarms, etc.) is restricted.

To reduce the risk of accidents, take a break in good time to avoid tiredness or exhaustion.

The dusts (e.g. sawdust), vapor and smoke produced during operation may be dangerous to health. If dust levels are very high, wear a suitable respirator.

When the engine is running: Note that the chain continues to rotate for a short period after you let go of the throttle trigger (flywheel effect).

To reduce the risk of fire, do not smoke while operating or standing near your chainsaw. Note that combustible fuel vapor may escape from the fuel system.

Check the saw chain at regular short intervals during operation or immediately if there is a noticeable change in cutting behavior:

- Shut off the engine and wait until the chain comes to a complete standstill.
- Check condition and proper mounting.
- Check sharpness.

Do not touch the chain while the engine is running. If the chain becomes jammed by an obstruction, switch off the engine immediately before attempting to remove the obstruction – **risk of injury**.

Always shut off the engine before leaving the saw unattended.

Shut off the engine before changing the saw chain. This avoids the **risk of injury** from the engine starting unintentionally.

To reduce risk of fire, keep hot exhaust gases and hot muffler away from easily combustible materials (e.g. wood chips, bark, dry grass, fuel). Mufflers with a catalytic converter can become particularly hot.

Never operate your saw without proper chain lubrication – check oil level regularly during operation. Stop work immediately if the oil level is too low and refill the oil tank – see also chapters on "Filling Chain Oil Tank" and "Checking Chain Lubrication".

If your saw is subjected to unusually high loads for which it was not designed (e.g. heavy impact or a fall), always check that it is in good condition before continuing work – see also "Before Starting Work".

Check the fuel system in particular for leaks and make sure the safety devices are working properly. Do not continue operating your saw if it is damaged. In case of doubt, have the unit checked by your servicing dealer.

Make sure the idle speed setting is correct. The chain must not run when the engine is idling with the throttle trigger released. Check and correct the idle speed setting regularly. If the chain continues to rotate when the engine is idling, have your dealer make proper adjustments or repairs.



The chain saw produces poisonous exhaust gases as soon as the engine starts. These gases may be colourless and odourless and may contain unburnt hydrocarbons and benzene. Never work with the machine indoors or in poorly ventilated areas, even if your machine is equipped with a catalytic converter.

Ensure proper ventilation when working in trenches, hollows or other confined locations – **risk of fatal injury from breathing toxic fumes!**

If you feel sick, have a headache, vision problems (e. g., your field of vision gets smaller), hearing problems, dizziness or inability to concentrate, stop work immediately. Such symptoms may be caused by an excessively high concentration of exhaust emissions – **risk of accident!**

After finishing work

Switch off the motor, engage the chain brake and attach the chain scabbard.

Storage

When the machine is not in use, it should be stored in such a way that no one is endangered. Secure the machine against unauthorised use.

Store the machine in a safe, dry room.

Loss-proof chain scabbard

The loss-proof chain scabbard is designed especially for using the chain saw in a tree.

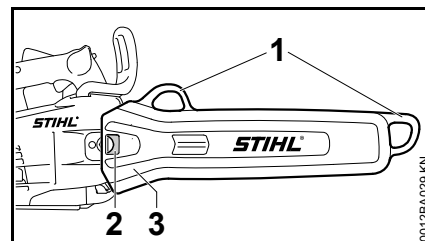

Rings (1) – for fastening the chain scabbard to the user's harness.

Snap fitting (2) – the loss-proof chain scabbard is held firmly on the sprocket cover of the chain saw. This keeps it from slipping off of the guide bar during transport.

Broad base (3) – for covering the spiked bumper

Application

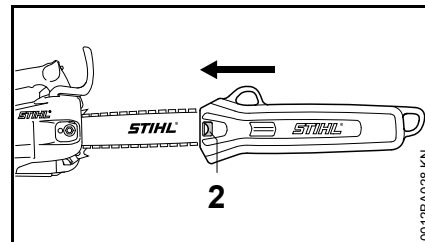

Always push the chain scabbard onto the guide bar as far as it will go. Snap fitting (2) must snap onto the chain sprocket cover.

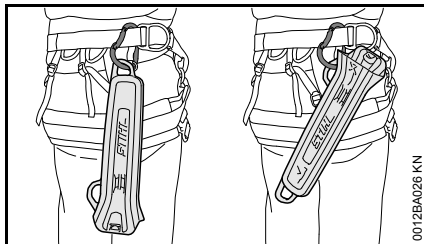

Always use one of the two rings to fasten the chain scabbard to the harness for storage while working.

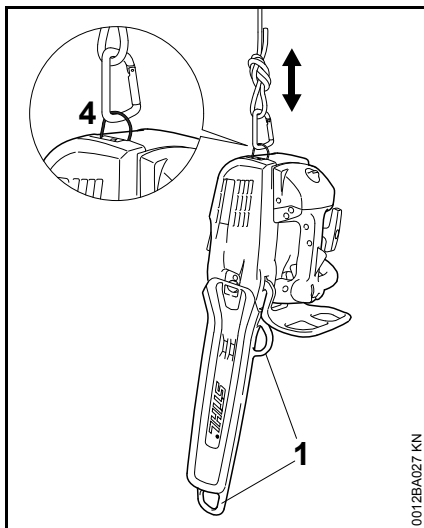

Always use the pull-out ring (4) on the back of the chain saw to transport and secure the chain saw on a rope.

Never use one of the chain scabbard rings (1) to transport or secure the chain saw – **risk of accident due to falling chain saw!**

Vibrations

Prolonged use of the power tool may result in vibration-induced circulation problems in the hands (whitefinger disease).

No general recommendation can be given for the length of usage because it depends on several factors.

The period of usage is prolonged by:

- Hand protection (wearing warm gloves)
- Work breaks

The period of usage is shortened by:

- Any personal tendency to suffer from poor circulation (symptoms: frequently cold fingers, tingling sensations).
- Low outside temperatures.
- The force with which the handles are held (a tight grip restricts circulation).

Continual and regular users should monitor closely the condition of their hands and fingers. If any of the above symptoms appear (e.g. tingling sensation in fingers), seek medical advice.

Maintenance and repairs

Always switch off the engine before any repair, cleaning or maintenance work and any work on the chain. **Risk of injury** if the engine starts inadvertently!

The machine must be serviced regularly. Do not attempt any maintenance or repair work not described in the Instruction Manual. All other work should be carried out by a servicing dealer.

STIHL recommends that maintenance and repair work be carried out only by authorised STIHL dealers. STIHL dealers receive regular training and are supplied with technical information.

Use only high-quality spare parts. Otherwise, there may be a risk of accidents and damage to the machine. If you have any questions in this respect, consult a servicing dealer.

Do not modify the machine in any way – this may increase the risk of personal injury – **risk of accidents!**

To reduce the **risk of fire** due to ignition outside the cylinder, move the master control level to **STOP, 0** or **⊖** before turning the engine over on the starter when the spark plug boot is removed or the spark plug is unscrewed!

Do not service or store the machine near a naked flame – **risk of fire** due to the fuel!

Check fuel cap regularly for tightness.

Use only spark plugs that are in perfect condition and have been approved by STIHL – see "Specifications".

Check ignition lead (insulation in good condition, secure connection).

Check that the muffler is in perfect working condition.

Do not use the machine if the muffler is damaged or missing – **risk of fire, damage to hearing!**

Never touch a hot muffler – **risk of burns!**

The condition of the anti-vibration elements influences vibration behaviour – inspect anti-vibration elements periodically.

Inspect chain catcher – replace if damaged.

Switch off the engine

- To check the chain tension
- To retension the chain
- To replace the chain
- For remedying malfunctions

Observe sharpening instructions – for safe and proper handling, always keep the chain and guide bar in flawless condition. Keep the chain properly sharpened, tensioned and well lubricated.

Change chain, guide bar and chain sprocket in due time.

Regularly check that the clutch drum is in perfect working condition.

Always store fuel and chain lubricant only in the specified type of containers and ensure they are correctly labelled. Store in a dry, cool and secure place protected against light and sunlight.

In the event of a chain brake malfunction, switch off the machine immediately – **risk of injury!** Consult a servicing dealer – do not use the machine until the malfunction has been remedied, see "Chain brake".

Reactive Forces

The most common reactive forces that occur during cutting are: kickback, pushback and pull-in.

Dangers of kickback



Kickback can result in serious or fatal injury.

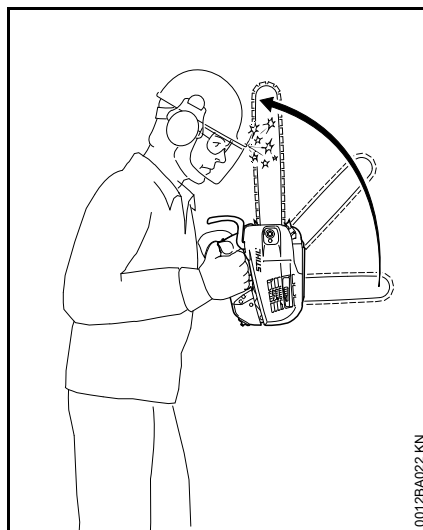

Kickback occurs when the saw is suddenly thrown up and back in an uncontrolled arc towards the operator.

Kickback occurs, e.g.

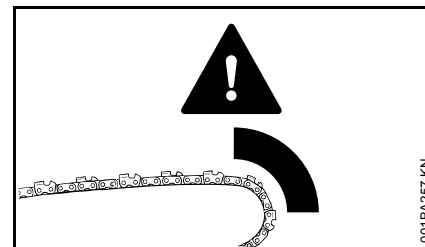

- when the upper quadrant of the bar nose unintentionally contacts wood or another solid object, e.g. when another limb is touched accidentally during limbing.
- when the chain at the nose of the guide bar is pinched in the cut.

QuickStop chain brake:

This device reduces the risk of injury in certain situations – it cannot prevent kickback. If activated, the brake stops the saw chain within a fraction of a second – for a description of this device refer to chapter on "Chain Brake" in this manual.

To reduce the risk of kickback

- Work cautiously and avoid situations which could cause kickback.
- Hold the saw firmly with both hands and maintain a secure grip.
- Always cut at full throttle.
- Be aware of the location of the guide bar nose at all times.

- Do not cut with the bar nose.
- Take special care with small, tough limbs, they may catch the chain.
- Never cut several limbs at once.
- Do not overreach.
- Never cut above shoulder height.
- Use extreme caution when re-entering a previous cut.
- Do not attempt plunge cuts if you are not experienced in this cutting technique.
- Be alert for shifting of the log or other forces that may cause the cut to close and pinch the chain.
- Always cut with a correctly sharpened, properly tensioned chain – the depth gauge setting must not be too large.
- Use a low kickback chain and a narrow radius guide bar.

Pull-in (A)

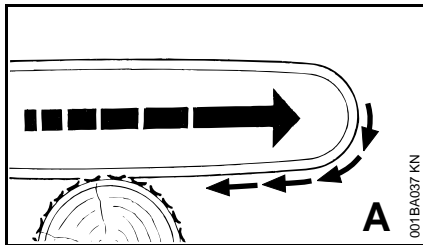

Pull-in occurs when the chain on the bottom of the bar is suddenly pinched, caught or encounters a foreign object in the wood. The reaction of the chain pulls the saw forward – **to reduce this risk, always engage the spiked bumper securely in the tree or limb.**

Pushback (B)

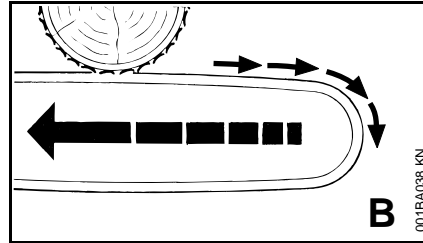

Pushback occurs when the chain on the top of the bar is suddenly pinched, caught or encounters a foreign object in the wood. The reaction of the chain drives the saw straight back toward the operator – **to avoid this risk:**

- Be alert to situations that may cause the top of the guide bar to be pinched
- Do not twist the guide bar in the cut.

Working Techniques

Cutting

Do not operate your saw in the starting throttle position. Engine speed cannot be controlled with the throttle trigger in this position.

Work calmly and carefully – in daylight conditions and only when visibility is good. Ensure you do not endanger others – stay alert at all times.

Use the shortest possible guide bar: The chain, guide bar and chain sprocket must match each other and your saw.

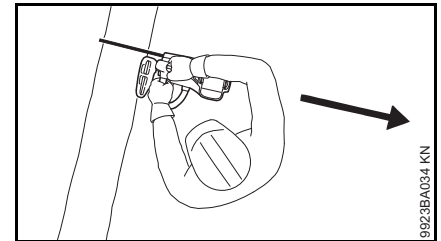

Position the saw so that your body is **clear of the cutting attachment.**

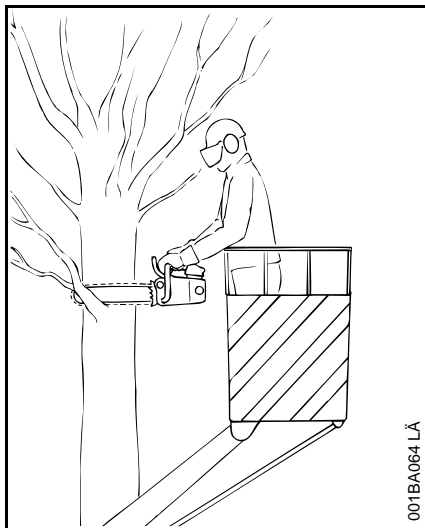

If conditions allow, work from a **lift bucket**.

Never work on a ladder or on any other insecure support, do not work above shoulder height.

Cordon off the work area in order to reduce the risk of injuries and damage to property from falling branches (e.g. motor vehicles).

When working with a lifeline there is a risk of cutting through the rope – **to reduce the risk of fall injuries**, always use double lifelines.

Take special care when cutting through a limb. Hold the machine firmly to control and counteract the feed force. Note when reaching the end of a cut that the saw is no longer supported in the kerf. You have to take the full weight of the saw – **increased risk of accidents**.

Make sure your saw does not touch any foreign materials: Stones, nails, etc. may be flung off and damage the saw chain. The saw may kick back unexpectedly – **risk of accidents**.

If the rotating chain makes contact with a rock or other solid object there is a risk of sparking which may cause easily combustible material to catch fire under certain circumstances. Dry plants and scrub are also easily combustible, especially in hot and dry weather conditions. If there is a risk of fire, do not use your chainsaw near combustible materials, dry plants or scrub. Always contact your local forest authority for information on a possible fire risk.



Warning! To avoid risk of electrocution, take extra precautions when cutting near power lines. Have the power switched off before starting cutting work in the immediate vicinity of power lines.

Do not underbuck freely hanging limbs because the chain **may get pinched and cause kickback and loss of control**.

Take care when cutting scrub and young trees. The saw chain may catch and throw thin shoots in your direction.

To reduce the risk of injury, take special care when cutting shattered wood because of the risk of injury from splinters being caught and thrown in your direction.

After finishing a cut, activate the chain brake to lock the chain or shut off the engine before moving the saw to another position in the tree.

Cutting techniques:

Start the cut with the chain running at full speed.

Always pull the saw out of the cut with the chain running.

- Cut straight through thin limbs
- In case of thick limbs, first perform relieving cut from below (approx. 1/5 of diameter), then buck from above
- Support and secure heavy branches with ropes.

If the saw gets pinched in the cut:

- Shut off the engine and secure the saw to the tree – in direction of trunk.
- Carefully free the saw from the cut, using another saw if necessary.

Limbs under tension:

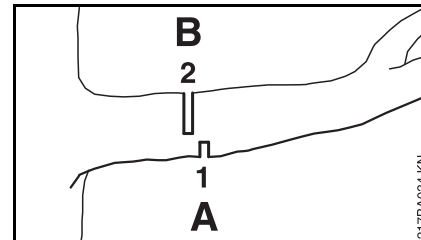

- Always start relieving cut (1) at the compression side (A).
- Make relieving cut (1) and then perform bucking cut (2) at the tension side (B) – the saw will otherwise pinch or kick back.

If not otherwise possible, make the bucking cut from the bottom upwards (underbuck) – **be wary of pushback**.

Cutting Attachment

A cutting attachment consists of the saw chain, guide bar and chain sprocket.

The cutting attachment that comes standard is designed to exactly match the chain saw.

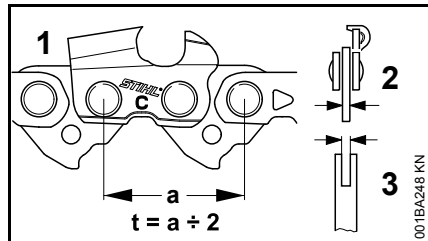

- The pitch (t) of the saw chain (1), chain sprocket and the nose sprocket of the Rollomatic guide bar must match.
- The drive link gauge (2) of the saw chain (1) must match the groove width of the guide bar (3).

If non-matching components are used, the cutting attachment may be damaged beyond repair after a short period of operation.

Mounting the Bar and Chain

Disengaging the Chain Brake

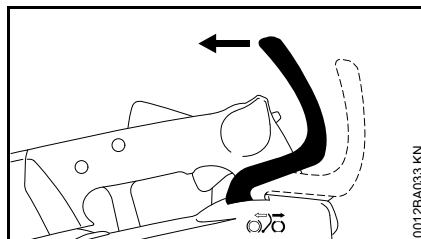

- Pull the hand guard towards the front handle until there is an audible click – the chain brake is disengaged.

Removing the Chain Sprocket Cover

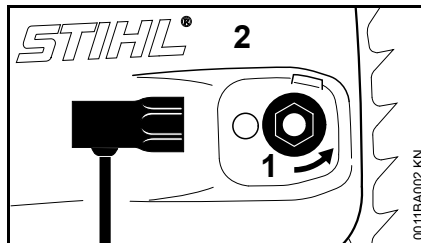

- Rotate the captive nut (1) counter-clockwise until it hangs loosely in the sprocket cover.
- Remove the sprocket cover (2) with captive nut.

Mounting the Guide Bar

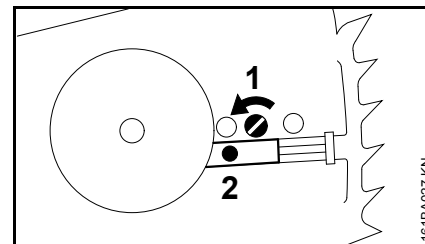

- Turn the screw (1) counterclockwise until the tensioner slide (2) butts against the left end of the housing slot.

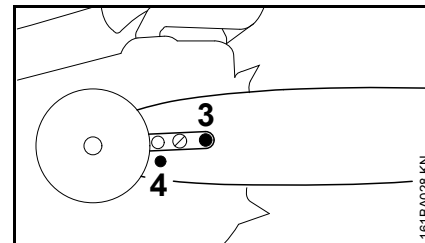

- Fit the guide bar over the stud (3) and engage the peg of the tensioner slide in the hole (4).

Fitting the Chain



WARNING

Wear work gloves to protect your hands from the sharp cutters.

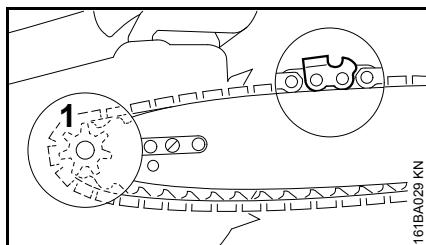

- Fit chain around the sprocket (1) and over the guide bar – the cutting edges on top of the bar must point to the bar nose.

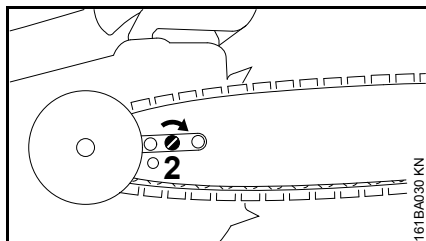

- Turn the screw (2) clockwise until there is very little chain sag on the underside of the bar – and the drive link tangs are engaged in the bar groove.

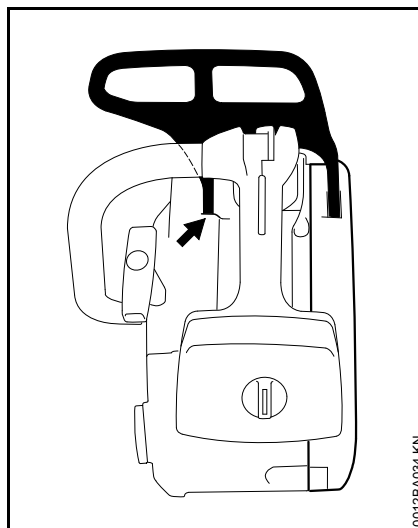

- Refit the chain sprocket cover – the pivot pin on the hand guard must engage the sleeve – and then screw the nut onto the stud finger-tight.
- Go to chapter on "Tensioning the Saw Chain"

Tensioning the Saw Chain (side chain tensioner)

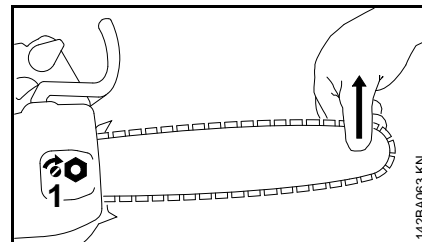

Retensioning during cutting work:

- Switch off the engine.
- Loosen the nut.
- Hold the bar nose up.
- Use a screwdriver to turn the tensioning screw (1) clockwise until the chain fits snugly against the underside of the bar.
- While still holding the bar nose up, tighten down the nut firmly.
- Go to "Checking Chain Tension".

A new chain has to be retensioned more often than one that has been in use for some time.

- Check chain tension frequently – see chapter on "Operating Instructions".

Checking Chain Tension

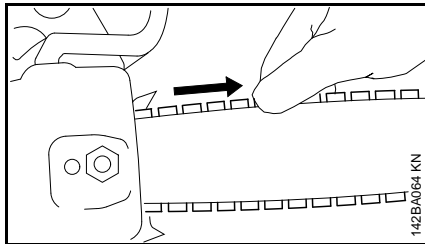

- Shut off the engine.
- Wear work gloves to protect your hands.
- The chain must fit snugly against the underside of the bar and it must still be possible to pull the chain along the bar by hand when the chain brake is released.
- If necessary, retension the chain.

A new chain has to be retensioned more often than one that has been in use for some time.

- Check chain tension frequently – see chapter on "Operating Instructions".

Fuel

Your engine requires a mixture of gasoline and engine oil.

WARNING

For health reasons, avoid direct skin contact with gasoline and avoid inhaling gasoline vapor.

STIHL MotoMix

STIHL recommends the use of STIHL MotoMix. This ready-to-use fuel mix contains no benzol or lead, has a high octane rating and ensures that you always use the right mix ratio.

STIHL MotoMix uses STIHL HP Ultra two-stroke engine oil for an extra long engine life.

MotoMix is not available in all markets.

Mixing Fuel

NOTICE

Unsuitable fuels or lubricants or mix ratios other than those specified may result in serious damage to the engine. Poor quality gasoline or engine oil may damage the engine, sealing rings, hoses and the fuel tank.

Gasoline

Use only high-quality **brand-name** gasoline with a minimum octane rating of 90 – leaded or unleaded.

Gasoline with an ethanol content of more than 10% can cause running problems in engines with a manually adjustable carburetor and should not be used in such engines.

Engines equipped with M-Tronic deliver full power when run on gasoline with an ethanol content of up to 25% (E25).

Engine Oil

If you mix the fuel yourself, use only STIHL two-stroke engine oil or another high-performance engine oil in accordance with JASO FB, JASO FC, JASO FD, ISO-L-EGB, ISO-L-EGC or ISO-L-EGD.

STIHL specifies STIHL HP Ultra two-stroke engine oil or an equivalent high-performance engine oil in order to maintain emission limits over the machine's service life.

Mix Ratio

STIHL 50:1 two-stroke engine oil: 50 parts gasoline to 1 part oil

Examples

Gasoline Liters	STIHL engine oil 50:1 Liters	(ml)
1	0.02	(20)
5	0.10	(100)
10	0.20	(200)
15	0.30	(300)
20	0.40	(400)
25	0.50	(500)

- Use a canister approved for storing fuel. Pour oil into canister first, then add gasoline and mix thoroughly.

Storing Fuel

Store fuel only in approved safety-type fuel canisters in a dry, cool and safe location protected from light and the sun.

Fuel mix ages – only mix sufficient fuel for a few weeks work. Do not store fuel mix for longer than 30 days. Exposure to light, the sun, low or high temperatures can quickly make the fuel mix unusable.

STIHL MotoMix may be stored for up to 2 years without any problems.

- Thoroughly shake the mixture in the canister before fueling your machine.

WARNING

Pressure may build up in the canister – open it carefully.

- Clean the fuel tank and canister from time to time.

Dispose of remaining fuel and cleaning fluid properly in accordance with local regulations and environmental requirements.

Fueling



Preparing the machine

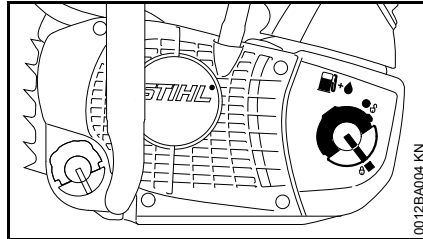

- Before fueling, clean the filler cap and the area around it so that dirt cannot fall into the fuel tank
- Always position the machine so that the filler cap is facing upwards

Opening

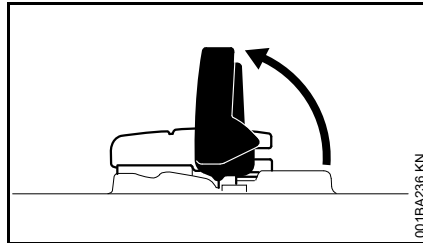

- Raise grip to vertical position.

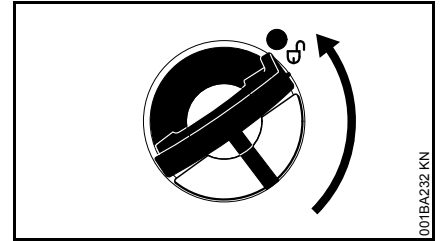

- Turn the cap counterclockwise (about a quarter turn).

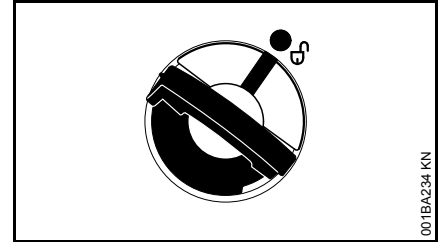

Marks on tank cap and fuel tank must line up.

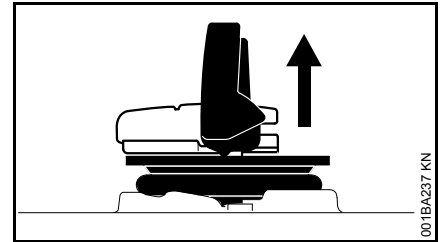

- Remove the tank cap.

Filling Up with Fuel

Take care not to spill fuel while fueling and do not overfill the tank.

STIHL recommends you use the STIHL filler nozzle for fuel (special accessory).

- Fill the fuel tank.

Closing

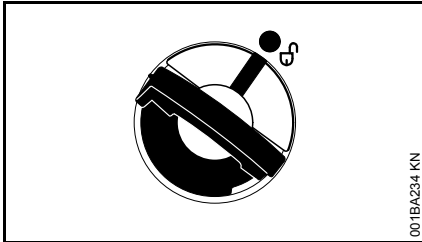

Grip must be vertical:

- Fit the cap – marks on tank cap and fuel tank must line up.
- Press the cap down as far as stop.

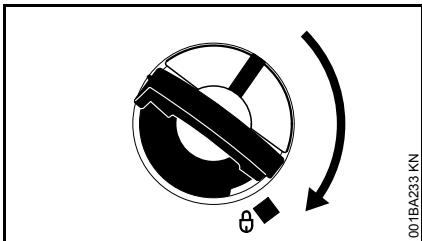

- While holding the cap depressed, turn it clockwise until it engages in position.

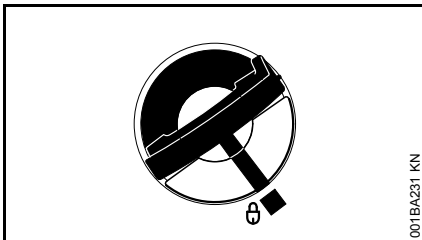

The marks on the tank cap and fuel tank are then in alignment.

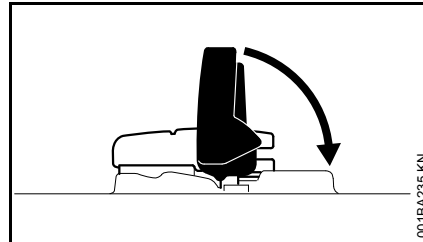

- Fold the grip down.

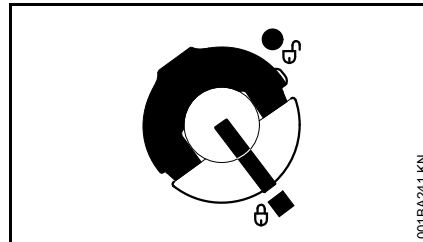

Tank cap is locked.

If the tank cap cannot be locked in the fuel tank opening

Bottom of cap is twisted in relation to top.

- Remove the cap from the fuel tank and check it from above.

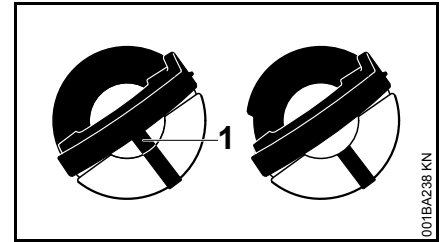

Left: Bottom of cap is twisted – inner mark (1) in line with outer mark.

Right: Bottom of cap in correct position – inner mark is under the grip. It is not in line with the outer mark.

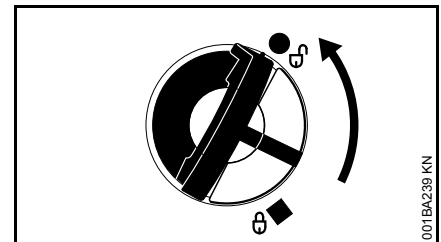

- Place the cap on the opening and rotate it counterclockwise until it engages the filler neck.
- Continue rotating the cap counterclockwise (about a quarter turn) – this causes the bottom of the cap to be turned to the correct position.
- Turn the cap clockwise and lock it in position – see section on "Closing".

Chain Lubricant

For automatic and reliable lubrication of the chain and guide bar – use only an environmentally compatible quality chain and bar lubricant. Rapidly biodegradable STIHL BioPlus is recommended.



NOTICE

Biological chain oil must be resistant to aging (e.g. STIHL BioPlus), since it will otherwise quickly turn to resin. This results in hard deposits that are difficult to remove, especially in the area of the chain drive and chain. It may even cause the oil pump to seize.

The service life of the chain and guide bar depends on the quality of the lubricant. It is therefore essential to use only a specially formulated chain lubricant.



WARNING

Do not use waste oil. Renewed contact with waste oil can cause skin cancer. Moreover, waste oil is environmentally harmful.



NOTICE

Waste oil does not have the necessary lubricating properties and is unsuitable for chain lubrication.

Filling Chain Oil Tank



Preparing the machine

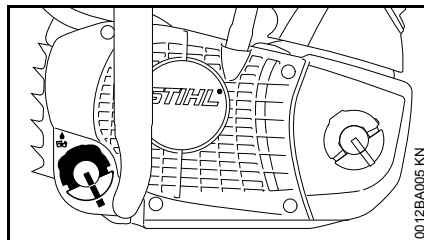

- Thoroughly clean the filler cap and the area around it to ensure that no dirt falls into the tank
- Always position the machine so that the filler cap is facing upwards
- Open the filler cap

Filling chain oil tank

- Refill the chain oil tank every time you refuel

Take care not to spill chain oil during refilling and do not overfill the tank.

STIHL recommends use of the STIHL filling system for chain oil (special accessory).

- Close the filler cap

There must still be a small amount of chain oil in the oil tank when the fuel tank is empty.

If the oil tank is still partly full, the reason may be a problem in the oil supply system: Check chain lubrication, clean the oil passages, contact your servicing dealer for assistance if necessary. STIHL recommends that maintenance and repair work be carried out only by authorized STIHL dealers.

Checking Chain Lubrication

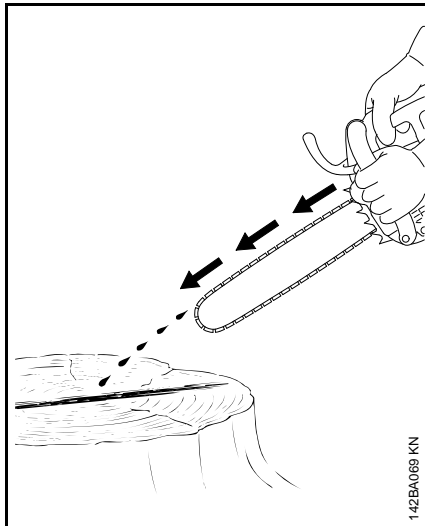

The saw chain must always throw off a small amount of oil.



NOTICE

Never operate your saw without chain lubrication. If the chain runs dry, the whole cutting attachment will be irretrievably damaged within a very short time. Always check chain lubrication and the oil level in the tank before starting work.

Every new chain has to be broken in for about 2 to 3 minutes.

After breaking in the chain, check chain tension and adjust if necessary – see "Checking Chain Tension".

Chain Brake



Locking the Chain

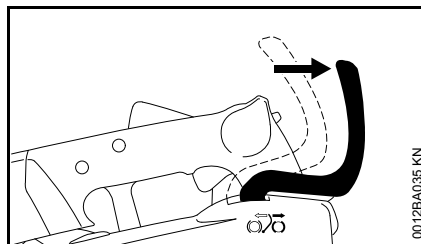

- in an emergency
- when starting
- at idling speed

The chain brake is activated by pushing the hand guard toward the bar nose with your left hand – or by inertia in certain kickback situations: The chain is stopped and locked.

Disengaging the Chain Brake

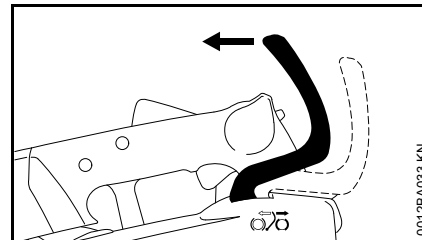

- Pull the hand guard towards the front handle until there is an audible click – the chain brake is disengaged.



NOTICE

Always disengage chain brake before accelerating the engine (except when checking its operation) and before starting cutting work.

High revs with the chain brake engaged (chain locked) will quickly damage the powerhead and chain drive (clutch, chain brake).

The chain brake is also activated by the inertia of the front hand guard if the kickback force of the saw is high enough: The hand guard is accelerated toward the bar nose.

The chain brake will operate only if the hand guard has not been modified in any way.

Checking Operation of the Chain Brake

Before starting work: Run engine at idle speed, engage the chain brake (push hand guard towards bar nose) and open the throttle wide for no more than

3 seconds – the chain must not rotate. The hand guard must be free from dirt and move freely.

Chain Brake Maintenance

The chain brake is subject to normal wear. It is necessary to have it serviced and maintained regularly by trained personnel. STIHL recommends that you have servicing and repair work carried out exclusively by an authorized STIHL servicing dealer. Maintain the following servicing intervals:

Full-time usage:	every 3 months
Part-time usage:	every 6 months

Winter Operation



At temperatures below +10 °C

- Remove chain sprocket cover – see "Mounting the bar and chain"

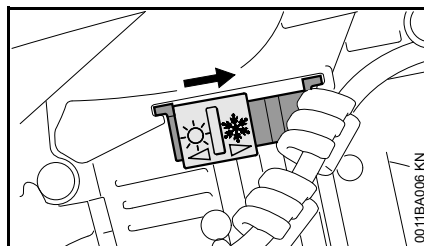

- Set shutter to "winter operation" ❄️

In the "winter operation" setting, heated air is drawn in from around the cylinder and mixed with cold air. This prevents air filter and carburetor icing.

At temperatures above +20 °C

- Always return the shutter to the position for "summer operation" ☀️



Risk of engine malfunction – overheating!

Starting / Stopping the Engine

Positions of Master Control Lever

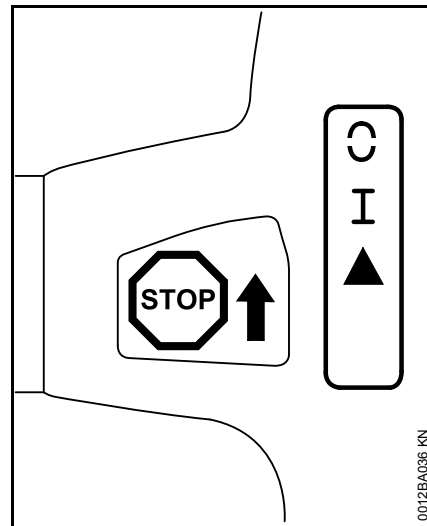

STOP or ☹️ – Master Control lever must be pushed in direction of **STOP** or ☹️ to switch off ignition. The Master Control lever springs back to the run position **I** when it is released.



The ignition is switched on again automatically after the engine stops. Engine can be started by operating the rewind starter.

Run position I – a hot engine is started in this position or the engine runs in this position.

Start position ▲ – a cold engine is started in this position.

Setting the Master Control Lever

To move the Master Control lever from the run position **I** to start **▲**, depress the trigger lockout and the throttle trigger and hold them in that position – set the Master Control lever to start **▲** and let go of the throttle trigger and trigger lockout. Release the Master Control lever – it then returns automatically to the start position **▲**.

The Master Control lever moves from the start position (**▲**) to the run position (**I**) when you press down the throttle trigger lockout and squeeze the throttle trigger at the same time.

To switch off the engine, move the Master Control lever in the direction of **STOP** or **⏏** – when released, the Master Control lever springs back to the run position **I**.

Holding the Saw

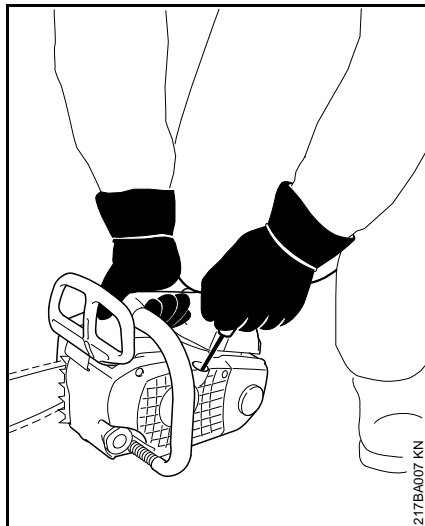

- Place your saw on the ground. Make sure you have a firm footing – check that the chain is not touching any object or the ground.
- Hold the saw firmly with your right hand on the top handle.
- Rest your right knee on the carburetor box cover.

Cranking

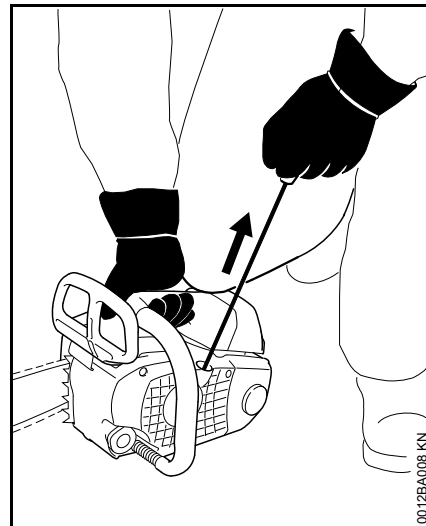

- Pull the starter grip slowly with your left hand until you feel it engage – and then give it a brisk strong pull and push down the front handle at the same time. Do not pull out the starter rope to full length – **it might otherwise break**. Do not let the starter grip snap back. Guide it slowly back into the housing so that the starter rope can rewind properly.

Machines without additional manual fuel pump: If the engine is new or after a long out-of-service period, it may be necessary to pull the starter rope several times to prime the fuel system.

Starting the saw

! WARNING

Bystanders must be well clear of the general work area of the saw.

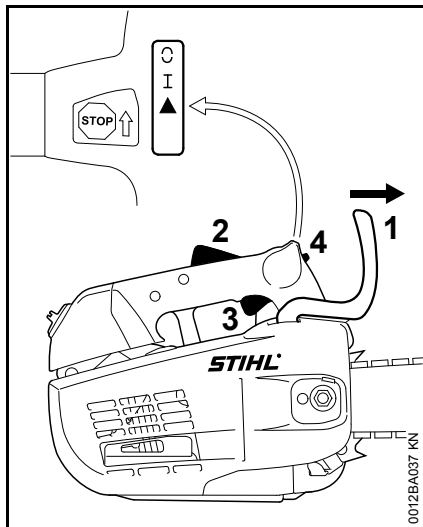

- Push the hand guard (1) forward – the chain is locked.

The Master Control lever (4) is in the normal run position **I**.

- If the engine is cold: Press down the trigger lockout (2) and pull the throttle trigger (3) at the same time. Hold both levers in that position and set the Master Control lever (4) to start symbol **▲**.
- Hold your saw firmly.

- Pull the starter grip quickly and firmly as often as necessary until the engine starts.
- If the engine does not start: Move the Master Control lever (4) to start position **▲** and repeat starting procedure.

As soon as the engine runs

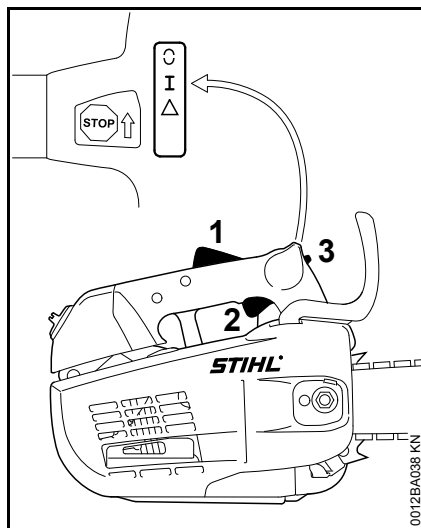

- If the engine was started in the start position **▲**: Press down trigger lockout (1) and pull the throttle trigger (2) at the same time – the Master Control lever (3) moves to the run position **I** and the engine settles down to idling speed.

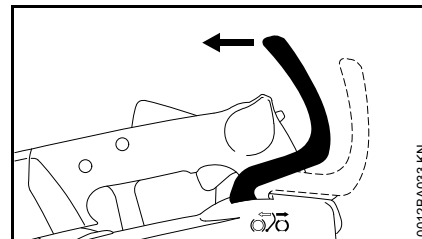

- Pull the hand guard back towards the front handle.

The chain brake is now disengaged – your saw is ready for operation.

⚙ NOTICE

Always disengage chain brake before accelerating the engine. High revs with the chain brake engaged (chain locked) will quickly damage the clutch and chain brake.

At very low outside temperatures

- Change over to winter operation if necessary – see "Winter Operation".

Stopping the Engine

- Move the Master Control lever in the direction of **STOP** or **⌚** – when released, the Master Control lever springs back to the normal run position **I**.

If engine does not start

- Check that all settings are correct.
- Check that there is fuel in the tank and refuel if necessary.

- Check that the spark plug boot is properly connected.
- Repeat the starting procedure.

or:

It is possible that the fuel-air mixture in the combustion chamber is over-rich and has flooded the engine.

- Remove the spark plug – see "Spark Plug".
- Dry the spark plug.
- Hold the saw on the ground.
- Push the Master Control lever as far as stop in direction of **STOP** or ↺ and hold it there.



WARNING

An ignition spark may occur if the Master Control lever is not held against **STOP** or ↺.

- Operate the rewind starter several times.
- Release the Master Control lever – it springs back to the run position **I**.
- Install the spark plug – see "Spark Plug".
- Hold and start your saw as described.

Operating Instructions

During the break-in period

A factory new machine should not be run at high revs (full throttle off load) for the first three tank fillings. This avoids unnecessarily high loads during the break-in period. As all moving parts have to bed in during the break-in period, the frictional resistances in the shortblock are greater during this period. The engine develops its maximum power after about 5 to 15 tank fillings.

During work



NOTICE

Open the throttle only when the chain brake is off. Running the engine at high revs with the chain brake engaged (chain locked) will quickly damage the engine and chain drive (clutch, chain brake).

Check chain tension frequently

A new saw chain must be retensioned more frequently than one that has been in use already for an extended period.

Chain cold

Tension is correct when the chain fits snugly against the underside of the bar but can still be pulled along the bar by hand. Retension if necessary – see "Tensioning the Saw Chain".

Chain at operating temperature

The chain stretches and begins to sag. The drive links must not come out of the bar groove on the underside of the bar – the chain may otherwise jump off the bar. Retension the chain – see "Tensioning the Saw Chain".



NOTICE

The chain contracts as it cools down. If it is not slackened off, it can damage the crankshaft and bearings.

After a long period of full-throttle operation

After a long period of full-throttle operation, allow engine to run for a while at idle speed so that the heat in the engine can be dissipated by flow of cooling air. This protects engine-mounted components (ignition, carburetor) from thermal overload.

After finishing work

- Slacken off the chain if you have retensioned it at operating temperature during work.



NOTICE

Always slacken off the chain again after finishing work. The chain contracts as it cools down. If it is not slackened off, it can damage the crankshaft and bearings.

Short-term storage

Wait for engine to cool down. Keep the machine with a full tank of fuel in a dry place, well away from sources of ignition, until you need it again.

Long-term storage

See "Storing the machine"

Oil Quantity Control

Varying cutting lengths, types of wood and work techniques require varying amounts of oil.

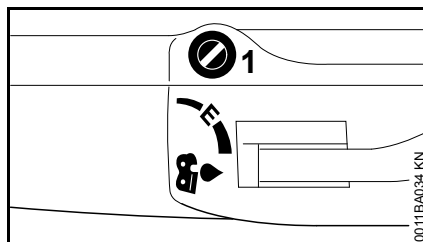

The oil flow can be adjusted as needed using the adjusting screw (1) on the top of the machine.

Ematic position (E), medium oil flow –

- Turn adjusting screw to "E" (Ematic position)

To increase oil flow –

- turn the adjusting screw clockwise

To reduce oil flow –

- turn the adjusting screw counterclockwise



NOTICE

The chain must always be coated with oil.

Taking Care of the Guide Bar

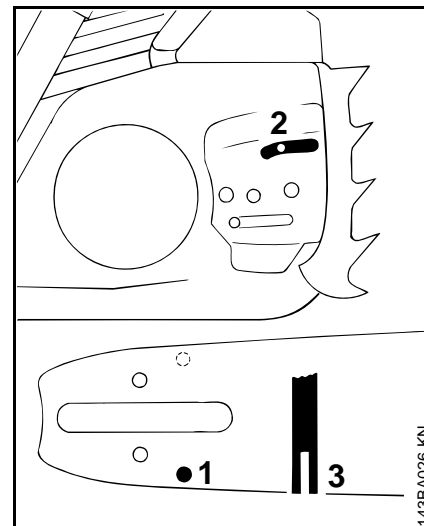

- Flip the bar – after each sharpening and each time the chain is changed – to avoid uneven wear, especially at the sprocket nose and on the bottom
- Periodically clean the oil inlet hole (1), oil outlet channel (2) and bar groove (3)
- Measure groove depth – using the measuring tool on the file gauge (special accessory) – in the area with the greatest wear

Chain type	Chain pitch	Minimum groove depth
Picco	1/4" P	4.0 mm
Rapid	1/4"	4.0 mm

Picco	3/8" P	5.0 mm
Rapid	3/8"; 0.325"	6.0 mm
Rapid	0.404"	7.0 mm

If the groove is not at least this deep:

- Replace guide bar

Otherwise the drive links will grind against the base of the groove – the bottoms of the cutters and the tie straps will not lie against the bar.

Cleaning the Air Filter

If there is a noticeable loss of engine power:

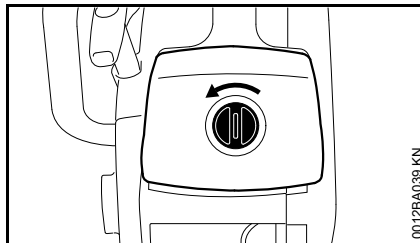

- Turn the twist lock 90° counterclockwise.
- Remove the shroud upwards.

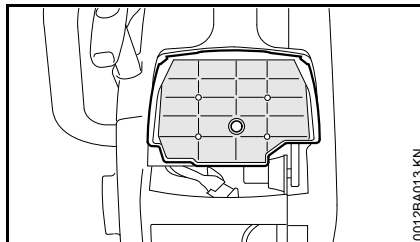

- Remove the air filter upwards.
- Wash the filter in STIHL special cleaner (special accessory) or a clean, non-flammable solution (e.g. warm soapy water) and then dry.

NOTICE

Do not clean a fleece filter (option) with a brush.

Always replace a damaged filter.

M-Tronic

The chainsaw adjusts itself automatically for optimum performance during operation. Calibration enables the saw to be adjusted faster for optimum performance.

If the outside temperature is below – 10°C or the engine is cold:

- Start the engine and disengage the chain brake.
- Warm up the engine by opening and closing the throttle for about 1 minute.
- Shut off the engine.

Calibrate the chainsaw as follows:

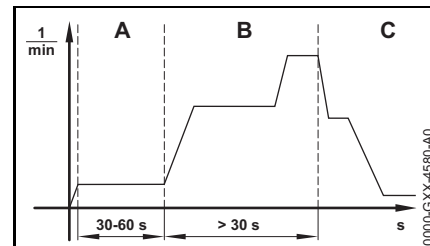

- Set Master Control lever to position ▲.
- Engage the chain brake.
- Start the engine without depressing the throttle trigger. The engine runs and the Master Control lever remains in position ▲.
- Run the engine for at least 30 seconds but no more than 60 seconds without depressing the throttle trigger.

WARNING

If the chain brake is disengaged, the chain may rotate - **risk of injury**.

Hold your chainsaw as described in the instruction manual and do not touch the rotating saw chain.

- Disengage the chain brake.

NOTICE

The calibration process is aborted if the throttle trigger is released before the saw is properly calibrated. It is then necessary to restart the calibration process.

- Keep the throttle trigger fully depressed.

NOTICE

The chainsaw can be incorrectly calibrated if the throttle trigger is not kept fully depressed during calibration. This can damage the saw.

- Keep the throttle trigger fully depressed.
- Depress the throttle trigger for at least 30 seconds and hold it in that position.

The engine accelerates and the chain rotates. Calibration of the saw takes place. Engine speed varies noticeably during calibration.

If the engine stalls:

- Make another attempt to calibrate the saw.

If the engine stalls again:

- Engage the chain brake.
- Do not use your chainsaw and contact your STIHL servicing dealer for assistance. Your saw has a malfunction.

As soon as the engine speed drops noticeably:

- Release the throttle trigger.

The engine runs at idling speed Your saw is calibrated and ready for operation.

Spark Plug

- If the engine is down on power, difficult to start or runs poorly at idle speed, first check the spark plug.
- Fit a new spark plug after about 100 operating hours – or sooner if the electrodes are badly eroded. Install only suppressed spark plugs of the type approved by STIHL – see "Specifications".

Removing the Spark Plug

- Move the Master Control lever to the stop position (0).

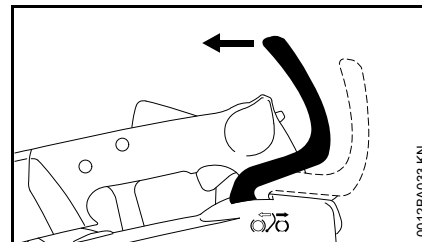

- Disengage the chain brake.

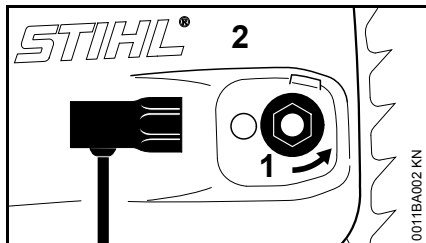

- Rotate the captive nut (1) counterclockwise until it hangs loosely in the sprocket cover.
- Remove the sprocket cover (2) with captive nut.

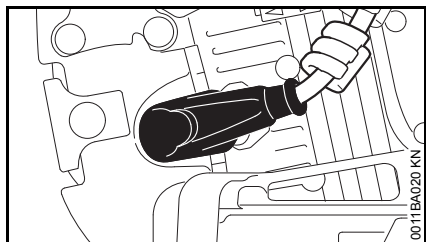

- Pull off the spark plug boot.
- Unscrew the spark plug.

Checking the Spark Plug

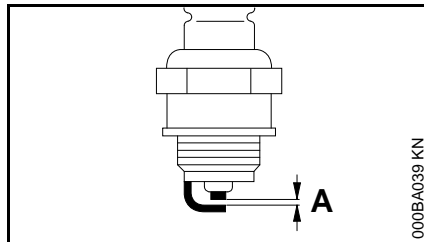

- Clean dirty spark plug.
- Check electrode gap (A) and readjust if necessary – see "Specifications".
- Rectify the problems which have caused fouling of the spark plug.

Possible causes are:

- Too much oil in fuel mix.
- Dirty air filter.
- Unfavorable running conditions.

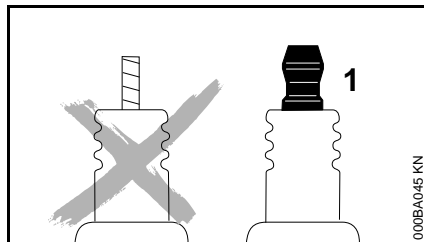

WARNING

Arcing may occur if the adapter nut (1) is loose or missing. Working in an easily combustible or explosive atmosphere may cause a fire or an explosion. This can result in serious injuries or damage to property.

- Use resistor type spark plugs with a properly tightened adapter nut.

Installing the spark plug

- Install the spark plug and connect the spark plug boot (press it down firmly) – reassembly all other parts in the reverse sequence.

Storing the Machine

For periods of 3 months or longer

- Drain and clean the fuel tank in a well ventilated area.
- Dispose of fuel properly in accordance with local environmental requirements.
- Run the engine until the carburetor is dry – this helps prevent the carburetor diaphragms sticking together.
- Remove the saw chain and guide bar, clean them and spray with corrosion inhibiting oil.
- Thoroughly clean the machine – pay special attention to the cylinder fins and air filter.
- If you use a biological chain and bar lubricant, e.g. STIHL BioPlus, completely fill the chain oil tank.
- Store the machine in a dry, high or locked location, out of the reach of children and other unauthorized persons.

Checking the Chain Sprocket

- Disengage the chain brake: Pull the hand guard toward the front handle.
- Remove the chain sprocket cover, chain and guide bar.

Replace the chain sprocket

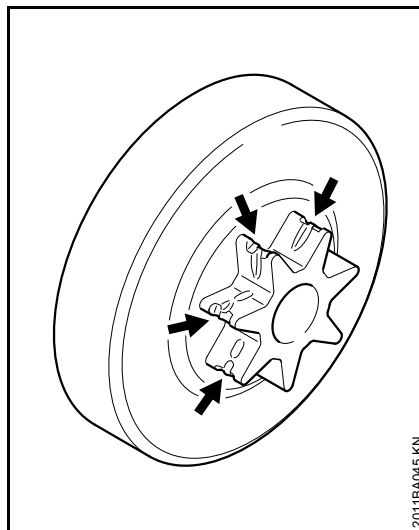

- after using two saw chains or sooner
- if the wear marks (arrows) on the sprocket are deeper than approx. 0.5 mm since this would reduce the life of the chain. You can use a gauge (special accessory) to check the depth of the wear marks.

It is best to use two saw chains in rotation with one sprocket.

STIHL recommends the use of original STIHL sprockets to ensure correct operation of the chain brake.

Have the chain sprocket replaced by a servicing dealer. STIHL recommends that you have servicing and repair work carried out exclusively by an authorized STIHL servicing dealer.

Maintaining and Sharpening the Saw Chain

Sawing effortlessly with a properly sharpened saw chain

A properly sharpened saw chain cuts through wood effortlessly even with very little pushing.

Never use a dull or damaged saw chain – this leads to increased physical strain, increased vibration load, unsatisfactory cutting results and increased wear.

- Clean the saw chain
- Check the saw chain for cracks and damaged rivets
- Replace damaged or worn chain components and adapt these parts to the remaining parts in terms of shape and level of wear – rework accordingly

Carbide-tipped (Duro) saw chains are especially wear-resistant. For an optimal sharpening result, STIHL recommends STIHL servicing dealers.

WARNING

Compliance with the angles and dimensions listed below is absolutely necessary. An improperly sharpened saw chain – especially depth gauges that are too low – can lead to increased kickback tendency of the chain saw – **risk of injury!**

Chain pitch

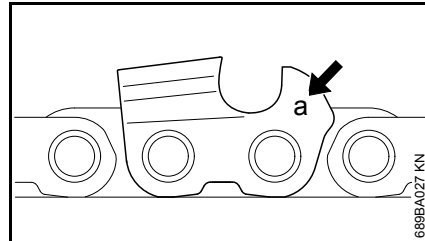

The chain pitch marking (**a**) is embossed in the area of the depth gauge of each cutter.

Marking (a)	Chain pitch	
	Inches	mm
7	1/4 P	6.35
1 or 1/4	1/4	6.35
6, P or PM	3/8 P	9.32
2 or 325	0.325	8.25
3 or 3/8	3/8	9.32
4 or 404	0.404	10.26

The diameter of file to be used depends on the chain pitch – see table "Sharpening tools".

The angles of the cutter must be maintained during reshaping.

Sharpening and side plate angles

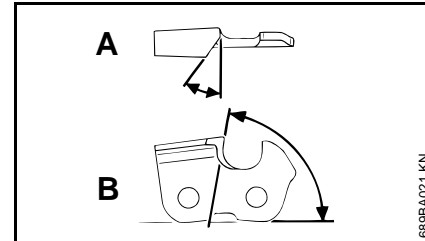

A Sharpening angle

STIHL saw chains are sharpened with a 30° sharpening angle. Ripping chains, which are sharpened with a 10° sharpening angle, are exceptions. Ripping chains have an X in the designation.

B Side plate angle

The correct side plate angle results automatically when the specified file holder and file diameter are used.

Tooth shapes	Angle (°)	
	A	B
Micro = semi-chisel tooth, e. g., 63 PM3, 26 RM3, 36 RM	30	75
Super = full chisel tooth, e. g., 63 PS3, 26 RS, 36 RS3	30	60
Ripping chain, e. g., 63 PMX, 36 RMX	10	75

The angles must be identical for all cutters in the saw chain. Varying angles: Rough, uneven running of the saw chain, increased wear – even to the point of saw chain breakage.

File holder

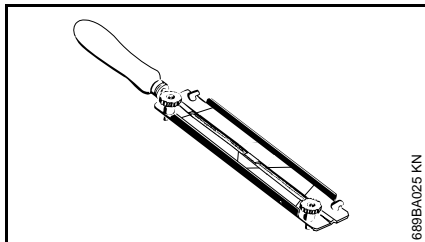

- **Use a file holder**

Always use a file holder (special accessory, see table "Sharpening tools") when sharpening saw chains by hand. File holders have markings for the sharpening angle.

Use only special saw chain files! Other files are unsuitable in terms of shape and type of cutting.

To check the angles

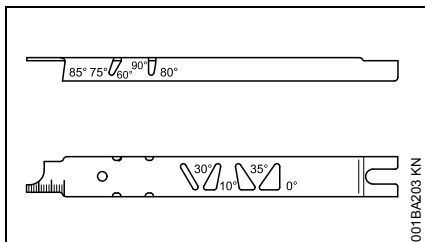

STIHL filing gauge (special accessory, see table "Sharpening tools") – a universal tool for checking sharpening and side plate angles, depth gauge setting, and tooth length, as well as cleaning grooves and oil inlet holes.

Proper sharpening

- Select sharpening tools in accordance with chain pitch
- Clamp guide bar if necessary
- Block saw chain – push the hand guard forward
- To advance the saw chain, pull the hand guard toward the handlebar: The chain brake is disengaged. With the Quickstop Super chain brake system, additionally press the throttle trigger lockout
- Sharpen frequently, removing little material – two or three strokes of the file are usually sufficient for simple resharpenering

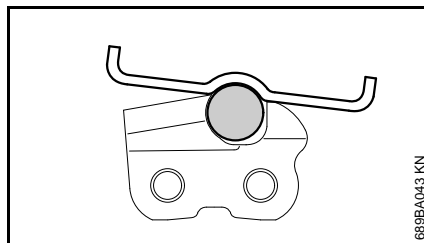
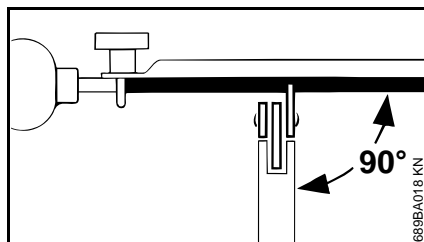

- Guide the file: **horizontally** (at a right angle to the side surface of the guide bar) in accordance with the specified angle – according to the

markings on the file holder – rest the file holder on the tooth head and the depth gauge

- File only from the inside outward
- The file only sharpens on the forward stroke – lift the file on the backstroke
- Do not file tie straps and drive links
- Rotate the file a little periodically in order to avoid uneven wear
- To remove file burr, use a piece of hardwood
- Check angle with file gauge

All cutters must be equally long.

With varying cutter lengths, the cutter heights also vary and cause rough running of the saw chain and chain breakage.

- All cutters must be filed down equal to the length of the shortest cutter – ideally, one should have this done by a servicing dealer using an electric sharpener

Depth gauge setting

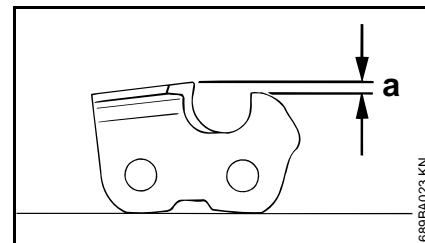

The depth gauge determines the depth to which the cutter penetrates the wood and thus the chip thickness.

- a Required distance between depth gauge and cutting edge

When cutting softwood outside of the frost season, the distance can be increased by up to 0.2 mm (0.008").

Chain pitch		Depth gauge Distance (a)	
Inches	(mm)	mm	(Inches)
1/4 P	(6.35)	0.45	(0.018)
1/4	(6.35)	0.65	(0.026)
3/8 P	(9.32)	0.65	(0.026)
0.325	(8.25)	0.65	(0.026)
3/8	(9.32)	0.65	(0.026)
0.404	(10.26)	0.80	(0.031)

Lowering the depth gauges

The depth gauge setting is lowered when the cutter is sharpened.

- Check the depth gauge setting after each sharpening

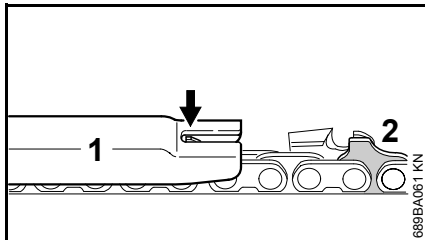

- Lay the appropriate file gauge (1) for the chain pitch on the saw chain and press it against the cutter to be checked – if the depth gauge protrudes past the file gauge, the depth gauge must be reworked

Saw chains with humped drive link (2) – upper part of the humped drive link (2) (with service mark) is lowered at the same time as the depth gauge of the cutter.

! WARNING

The rest of the humped drive link must not be filed; otherwise, this could increase the tendency of the chain saw to kick back.

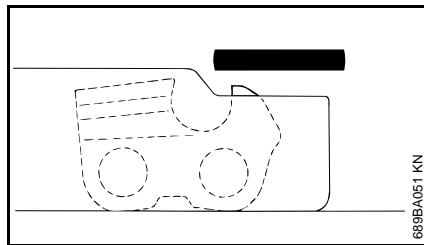

- Rework the depth gauge so that it is flush with the file gauge

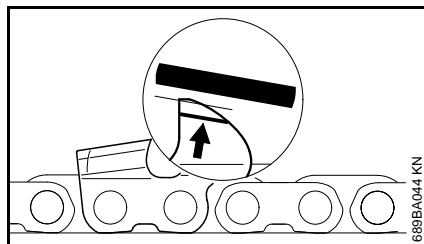

- Afterwards, dress the leading edge of the depth gauge parallel to the service mark (see arrow) – when doing this, be careful not to further lower the highest point of the depth gauge

! WARNING

Depth gauges that are too low increase the kickback tendency of the chain saw.

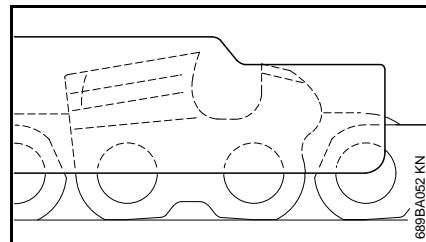

- Lay the file gauge on the saw chain – the highest point of the depth gauge must be flush with the file gauge
- After sharpening, clean the saw chain thoroughly, removing any filings or grinding dust – lubricate the saw chain thoroughly
- In the event of extended periods of disuse, store saw chains in cleaned and oiled condition

Sharpening tools (special accessories)

Chain pitch		Round file Ø		Round file	File holder	File gauge	Taper square file	Sharpening set ¹⁾
Inches	(mm)	mm	(Inches)	Part number	Part number	Part number	Part number	Part number
1/4P	(6.35)	3.2	(1/8)	5605 771 3206	5605 750 4300	0000 893 4005	0814 252 3356	5605 007 1000
1/4	(6.35)	4.0	(5/32)	5605 772 4006	5605 750 4327	1110 893 4000	0814 252 3356	5605 007 1027
3/8 P	(9.32)	4.0	(5/32)	5605 772 4006	5605 750 4327	1110 893 4000	0814 252 3356	5605 007 1027
0.325	(8.25)	4.8	(3/16)	5605 772 4806	5605 750 4328	1110 893 4000	0814 252 3356	5605 007 1028
3/8	(9.32)	5.2	(13/64)	5605 772 5206	5605 750 4329	1110 893 4000	0814 252 3356	5605 007 1029
0.404	(10.26)	5.5	(7/32)	5605 772 5506	5605 750 4330	1106 893 4000	0814 252 3356	5605 007 1030

¹⁾ consisting of file holder with round file, taper square file and file gauge

Maintenance and Care

The following information applies in normal operating conditions. The specified intervals must be shortened accordingly when working for longer than normal or under difficult cutting conditions (extensive dust, highly resinous lumber, lumber from tropical trees, etc.). If you only use the tool occasionally, extend the intervals accordingly.		Before starting work	At the end of work and/or daily	Whenever tank is refilled	Weekly	Monthly	Annually	If faulty	If damaged	As required
Complete machine	Visual inspection (condition, leaks)	X		X						
	Clean		X							
Throttle trigger, throttle trigger lockout, choke lever, stop switch, master control lever (dependent on equipment)	Function test	X		X						
Chain brake	Function test	X		X						
	Have checked by dealer ¹⁾									X
Manual fuel pump (if present)	check	X								
	Have repaired by a specialist dealer ¹⁾								X	
Fuel pick-up body / filter in fuel tank	check					X				
	Clean, replace filter insert					X		X		
	replace						X		X	X
Fuel tank	Clean					X				
Lubricating oil tank	Clean					X				
Chain lubrication	check	X								
Saw chain	Check, pay attention to sharpness	X		X						
	Checking the chain tension	X		X						
	sharpen									X
Guide bar	Check (wear, damage)	X								
	Clean and turn over									X
	Deburr				X					
	replace								X	X
Chain sprocket	check				X					
Air filter	Clean							X		X
	replace								X	

The following information applies in normal operating conditions. The specified intervals must be shortened accordingly when working for longer than normal or under difficult cutting conditions (extensive dust, highly resinous lumber, lumber from tropical trees, etc.). If you only use the tool occasionally, extend the intervals accordingly.		Before starting work	At the end of work and/or daily	Whenever tank is refilled	Weekly	Monthly	Annually	If faulty	If damaged	As required
Anti-vibration elements	check	X						X		
	Have replaced by servicing dealer ¹⁾								X	
Air intake on fan housing	Clean		X		X					X
Cylinder fins	Clean		X			X				X
Carburetor	Check idle adjustment – saw chain must not rotate	X		X						
	If the saw chain continues moving when the engine is idling, have your chainsaw checked and repaired by your dealer ¹⁾									X
Spark plug	Adjust electrode gap							X		
	Replace after 100 hours of operation									X
Accessible screws, nuts and bolts	Tighten ²⁾									X
Chain catcher	check	X								
	replace								X	
Safety information label	replace								X	

¹⁾ STIHL recommends STIHL dealers

²⁾ Firmly tighten down the cylinder base screws of chainsaws (3.4 kW or more) after 10 to 20 hours of operation.

Minimize Wear and Avoid Damage

Compliance with the specifications of this Instruction Manual will avoid excessive wear and damage to the machine.

The machine must be used, maintained and stored as carefully as described in this Instruction Manual.

The user is responsible for all damage caused by failure to comply with the safety, operating and maintenance instructions. This applies in particular for:

- Product modifications not authorized by STIHL
- Use of tools or accessories that are not approved for the machine, unsuitable or of inferior quality
- Use of the machine in a manner not in keeping with the intended use
- Use of the machine in sporting events or competitions
- Consequential damages due to continued use of a machine with defective components

Maintenance work

All of the tasks listed under "Maintenance and Care" must be carried out periodically. If the user does not carry out these maintenance tasks him- or herself, they should be delegated to a dealer.

STIHL recommends that maintenance and repair work be carried out only by authorized STIHL dealers. STIHL dealers receive regular training and are supplied with technical information.

If these tasks are not performed or are performed improperly, this may result in damage for which the user is responsible. These include, among others:

- Engine damage due to delayed or insufficient maintenance (e. g., air and fuel filters) or insufficient cleaning of the cooling air routing (air intake slits, cylinder fins)
- Corrosion damage and other consequential damages due to improper storage
- Damage to the machine as a result of using replacement parts of inferior quality

Parts Subject to Wear and Tear

Some parts of the power tool are subject to normal wear and tear even during regular operation in accordance with instructions and, depending on the type and duration of use, have to be replaced in good time. Among other parts, this includes:

- Saw chain, guide bar
- Drive components (clutch, clutch drum, chain sprocket)
- Filters (air, oil, fuel)
- Starter mechanism
- Spark plug
- Components of antivibration system

Main Parts

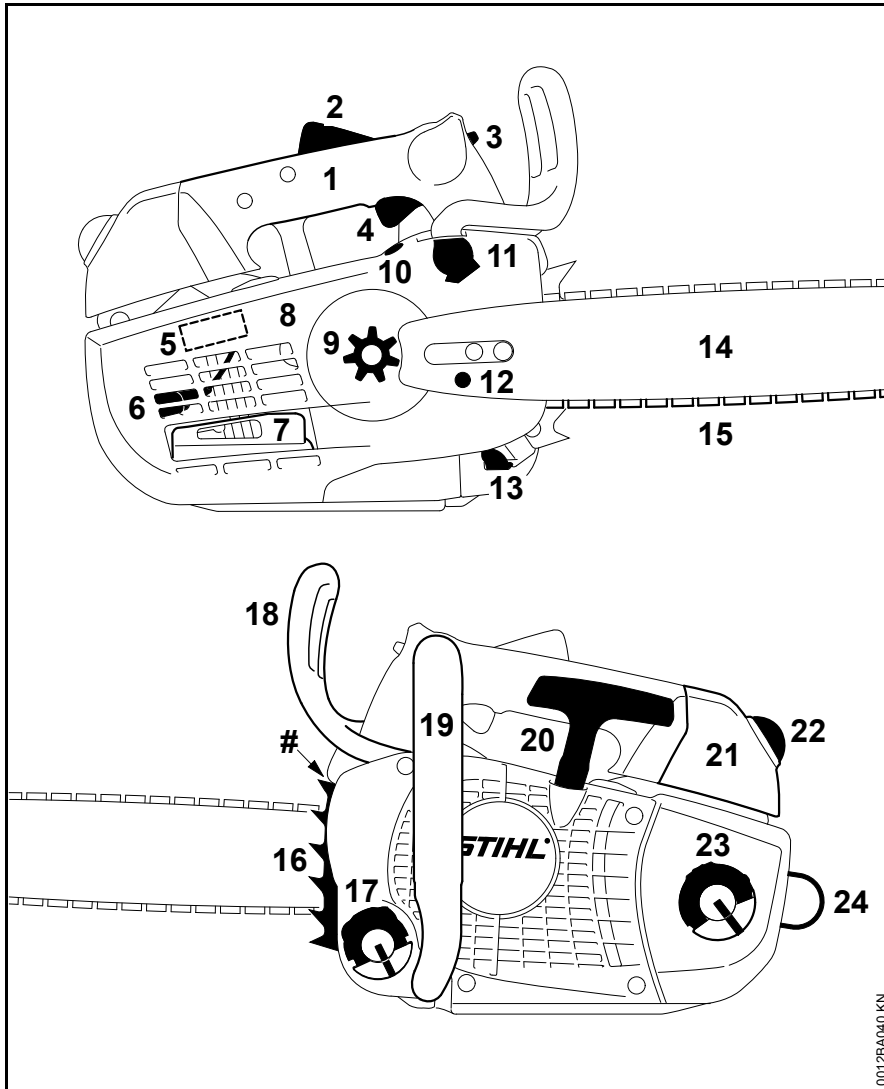

- 1 Control handle
- 2 Throttle trigger lockout
- 3 Master Control lever
- 4 Throttle trigger
- 5 Shutter (winter and summer mode)
- 6 Spark plug
- 7 Muffler
- 8 Chain sprocket cover
- 9 Chain sprocket
- 10 Oil quantity control
- 11 Chain brake
- 12 Chain tensioner
- 13 Chain catcher
- 14 Guide bar
- 15 Oilomatic chain
- 16 Spiked bumper
- 17 Oil filler cap
- 18 Hand guard
- 19 Handlebar
- 20 Starter grip
- 21 Carburetor box cover
- 22 Twist lock
- 23 Fuel filler cap
- 24 Ring
- # Serial number

0012BA040 KN

Specifications

Engine

Single cylinder two-stroke engine

Displacement:	35.2 cc
Bore:	40 mm
Stroke:	28 mm
Engine power to ISO 7293:	1.8 kW (2.4 bhp) at 10,500 rpm
Idle speed: ¹⁾	3,000 rpm

¹⁾ to ISO 11681 +/- 50 rpm

Ignition System

Electronic magneto ignition

Spark plug (resistor type):	NGK CMR 6 H
Electrode gap:	0.5 mm

Fuel System

All position diaphragm carburetor with integral fuel pump

Fuel tank capacity: 310 cc (0,31 l)

Chain Lubrication

Fully automatic, speed-controlled oil pump. Additional manual oil flow control

Oil tank capacity: 220 cc (0,22 l)

Weight

Dry, without bar and chain:

3.7 kg

Cutting Attachment

Actual cutting length may be less than the specified length

Rollomatic guide bars

Bar lengths (3/8" P pitch):	30, 35, 40 cm
Groove width:	1.3 mm

3/8" Picco chains

Picco Micro 3 (63 PM3) Type 3636

Pitch: 3/8" P (9.32 mm)

Drive link gauge: 1.3 mm

Picco Super 3 (63 PS3) Type 3616

Pitch: 3/8" P (9.32 mm)

Drive link gauge: 1.3 mm

Picco Duro 3 (63 PD3) Type 3612

Pitch: 3/8" P (9.32 mm)

Drive link gauge: 1.3 mm

Chain Sprockets

6-tooth for 3/8" P (spur sprocket)

Max. chain speed according to ISO 11681: 26.0 m/s

Chain speed at maximum power: 18.6 m/s

Sound and Vibration Levels

For further details concerning compliance with the Employers' Directive on Vibration 2002/44/EC, see www.stihl.com/vib

Sound pressure level L_{peq} to ISO 22868

100 dB(A)

Sound power level L_{weq} to ISO 22868

113 dB(A)

Vibration level $a_{hv,eq}$ to ISO 22867

	Handle, left	Handle, right
--	--------------	---------------

MS 201 TC-M

with 3/8" P chain: 3.5 m/s² 3.1 m/s²

The K-factor in accordance with Directive 2006/42/EC is 2.0 dB(A) for the sound pressure level and sound power level; the K-factor in accordance with Directive 2006/42/EC is 2.0 m/s² for the vibration level.

REACH

REACH is an EC regulation and stands for the Registration, Evaluation, Authorisation and Restriction of Chemical substances.

For information on compliance with the REACH regulation (EC) No. 1907/2006 see www.stihl.com/reach.

Disposal

Observe all country-specific waste disposal rules and regulations.

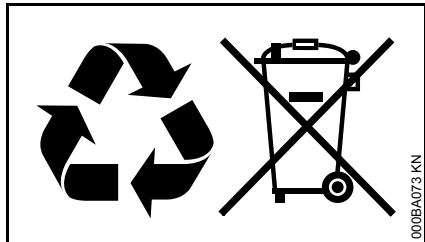

STIHL products must not be thrown in the garbage can. Take the product, accessories and packaging to an approved disposal site for environment-friendly recycling.

Contact your STIHL servicing dealer for the latest information on waste disposal.

EC Declaration of Conformity

ANDREAS STIHL AG & Co. KG
Badstr. 115
D-71336 Waiblingen

Germany

declares under our sole responsibility that

Designation:	Chainsaw
Make:	STIHL
Series:	MS 201 TC-M
Serial identification number:	1145
Displacement:	35.2 cc

conforms to the relevant provisions of Directives 2011/65/EU, 2006/42/EC, 2014/30/EU and 2000/14/EC and has been developed and manufactured in compliance with the following standards in the versions valid on the date of production:

EN ISO 11681-2, EN 61000-6-1,
EN 55012

The measured and the guaranteed sound power level have been determined in accordance with Directive 2000/14/EC, Annex V, and standard ISO 9207.

Measured sound power level

113 dB(A)

Guaranteed sound power level

115 dB(A)

The EC type examination was carried out by

DPLF

Deutsche Prüf- und Zertifizierungsstelle
für Land- und Forsttechnik GbR
(NB 0363)
Spremlberger Straße 1
D-64823 Groß-Umstadt

Certification No.:

K-EG -2010/5601

Technical documents deposited at:

ANDREAS STIHL AG & Co. KG
Produktzulassung

The year of manufacture and serial number are applied to the product.

Done at Waiblingen, 03.02.2020

ANDREAS STIHL AG & Co. KG

pp

A handwritten signature in black ink, appearing to read 'J. Hoffmann'.

Dr. Jürgen Hoffmann

Head of Product Data, Regulations and
Licensing

The CE mark, consisting of the letters 'C' and 'E' in a stylized, bold font.

0458-599-0121-B

englisch



www.stihl.com



0458-599-0121-B