

STIHL

STIHL HS 46, 56

Instruction Manual



Contents

Guide to Using this Manual	2
Safety Precautions and Working Techniques	2
Using the Unit	7
Fuel	8
Fueling	9
Starting / Stopping the Engine	11
Operating Instructions	13
Cleaning the Air Filter	14
Adjusting the Carburetor	14
Checking the Spark Plug	15
Lubricating the Gearbox	16
Storing the Machine	17
Sharpening Instructions	17
Maintenance and Care	18
Minimize Wear and Avoid Damage	20
Main Parts	21
Specifications	22
Maintenance and Repairs	23
Disposal	23
EC Declaration of Conformity	24

STIHL

HS 46, HS 46 C, HS 56 C

Dear Customer,

Thank you for choosing a quality engineered STIHL product.

It has been built using modern production techniques and comprehensive quality assurance. Every effort has been made to ensure your satisfaction and trouble-free use of the product.

Please contact your dealer or our sales company if you have any queries concerning this product.

Your



Dr. Nikolas Stihl

Guide to Using this Manual

Pictograms

The meanings of the pictograms attached to the machine are explained in this manual.

Depending on the model concerned, the following pictograms may be attached to your machine.



Fuel tank; fuel mixture of gasoline and engine oil

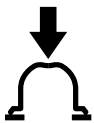

Operate manual fuel pump

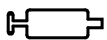

Filler hole for gear lubricant



Blade lock

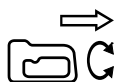

Rotating handle

Symbols in text



WARNING

Warning where there is a risk of an accident or personal injury or serious damage to property.



NOTICE

Caution where there is a risk of damaging the machine or its individual components.

Engineering improvements

STIHL's philosophy is to continually improve all of its products. For this reason we may modify the design, engineering and appearance of our products periodically.

Therefore, some changes, modifications and improvements may not be covered in this manual.

Safety Precautions and Working Techniques



Special safety precautions must be observed when working with this power tool because it has very sharp, high-speed cutting blades.



It is important that you read the instruction manual before first use and keep it in a safe place for future reference. Non-observance of the instruction manual may result in serious or even fatal injury.

Observe all applicable local safety regulations, standards and ordinances.

If you have not used this type of power tool before: Have your dealer or other experienced user show you how to operate your unit or attend a special course in its operation.

Minors should never be allowed to use a power tool.

Keep bystanders, especially children, and animals away from the work area.

When the power tool is not in use, shut it off so that it does not endanger others. Secure it against unauthorized use.

The user is responsible for avoiding injury to third parties or damage to their property.

Do not lend or rent your power tool without the instruction manual. Be sure that anyone using it understands the information contained in this manual.

The use of noise emitting power tools may be restricted to certain times by national or local regulations.

To operate the power tool you must be rested, in good physical condition and mental health.

If you have any condition that might be aggravated by strenuous work, check with your doctor before operating a power tool.

Persons with pacemakers only: The ignition system of your power tool produces an electromagnetic field of a very low intensity. This field may interfere with some pacemakers. STIHL recommends that persons with pacemakers consult their physician and the pacemaker manufacturer to reduce any health risk.

Do not operate the power tool if you are under the influence of any substance (drugs, alcohol) which might impair vision, dexterity or judgment.

Use your hedge trimmer only for cutting hedges, shrubs, scrub and similar materials. Do not use your power tool for any other purpose because of the **increased risk of accidents**.

Never attempt to modify your power tool in any way since this may result in accidents or damage to the machine.

Only use cutting blades and accessories that are explicitly approved for this power tool by STIHL or are technically identical. If you have any questions in this respect, consult a servicing dealer. Use only high quality tools and accessories. in order to avoid the risk of accidents and damage to the machine.

STIHL recommends the use of genuine STIHL tools and accessories. They are specifically designed to match the product and meet your performance requirements.

Never attempt to modify your unit in any way since this may increase the risk of personal injury. STIHL excludes all liability for personal injury and damage to property caused while using unauthorized attachments.

Do not use a pressure washer to clean the unit. The solid jet of water may damage parts of the unit.

Clothing and Equipment

Wear proper protective clothing and equipment.



Clothing must be sturdy but allow complete freedom of movement. Wear snug-fitting clothing, an overall and jacket combination, do not wear a work coat.

Avoid clothing that could get caught on branches or brush or moving parts of the machine. Do not wear a scarf, necktie or jewelry. Tie up and confine long hair (e.g. with a hair net, cap, hard hat, etc.).

Wear sturdy shoes with non-slip soles.

WARNING



To reduce the risk of eye injuries, wear snug-fitting safety glasses in accordance with European Standard EN 166. Make sure the safety glasses are a good fit.

Wear hearing protection, e.g. earplugs or ear muffs.



Wear heavy-duty work gloves made of durable material (e.g. leather).

STIHL offers a comprehensive range of personal protective clothing and equipment.

Transporting the Power Tool

Always turn off the engine.

Always fit the blade guard (scabbard) before carrying your hedge trimmer short distances.

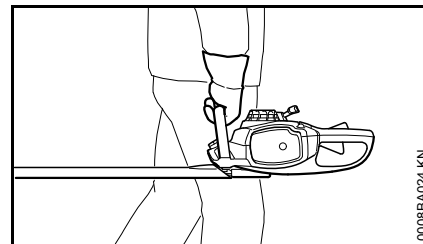

Carry the power tool by the handle – cutting blades behind you. Avoid touching hot parts of the machine, especially the muffler and gear housing – **you could suffer serious burns**.

In vehicles: Properly secure your power tool to prevent turnover, fuel spillage and damage.

Fueling



Gasoline is an extremely flammable fuel. Keep clear of naked flames. Do not spill any fuel – do not smoke.

Always **shut off the engine** before refueling.

Do not fuel a hot engine – **fuel may spill and cause a fire.**

Open the fuel cap carefully to allow any pressure build-up in the tank to release slowly and avoid fuel spillage.

Fuel your power tool only in well-ventilated areas. If you spill fuel, wipe the machine immediately – if fuel gets on your clothing, change immediately.





Insert the fuel cap with hinged grip (bayonet-type cap) correctly in the opening, turn it clockwise as far as stop and fold the grip down.

This reduces the risk of unit vibrations causing the fuel cap to loosen or come off and spill quantities of fuel.

To reduce the risk of serious or fatal burn injuries, check for fuel leakage. If fuel leakage is found, do not start or run the engine until leak is fixed.

Before Starting

Check that your power tool is properly assembled and in good condition – refer to appropriate chapters in the instruction manual.

- Check the fuel system for leaks, paying special attention to visible parts such as the tank cap, hose connections and the manual fuel pump (on machines so equipped). If there are any leaks or damage, do not start the engine – **risk of fire.** Have your machine repaired by a servicing dealer before using it again.
- Master Control lever must move easily in direction of **STOP** or  and spring back to the normal run position **I.**
- Action of Master Control lever, throttle trigger lockout and throttle trigger must be smooth – the throttle trigger must return automatically to the idle position. The Master Control lever must spring back from the  and  positions to the normal run position **I.**
- Check that the spark plug boot is secure – a loose boot may cause arcing that could ignite combustible fumes **and cause a fire.**
- Cutting blades securely mounted and in good condition (clean, move freely, not warped), properly sharpened and thoroughly sprayed with STIHL resin solvent (lubricant).
- Check cutter guard (if fitted) for damage.

- Never attempt to modify the controls or safety devices in any way.
- Keep the handles dry and clean – free from oil and dirt – for safe control of the power tool.

To reduce the risk of accidents, do not operate your power tool if it is damaged or not properly assembled.

Starting the Engine

Start the engine at least 3 meters from the fueling spot, outdoors only.

Place the power tool on firm ground in an open area. Make sure you have good balance and secure footing. Hold the power tool securely. The cutting blades must be clear of the ground and all other obstructions because they may begin to run when the engine starts.

Your power tool is designed to be operated by one person only. Do not allow other persons in the work area – even when starting.

To reduce the risk of injury, avoid contact with the cutting blades.

Do not drop start the power tool – start the engine as described in the instruction manual.

Note that the cutting blades continue to run for a short period after you let go of the throttle trigger – **flywheel effect.**

Check idle speed setting: The cutting blades must not move when the engine is idling with the throttle trigger released.

Holding and Controlling the Unit

Always hold the power tool firmly with both hands on the handles. Wrap your fingers and thumbs around the handles.

Right-handers

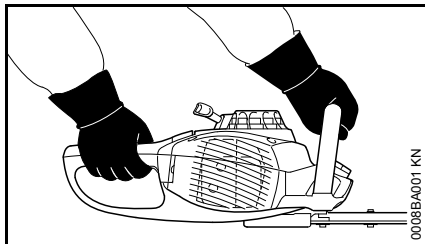

Right hand on the control handle and left hand on the front handle.

Left-handers

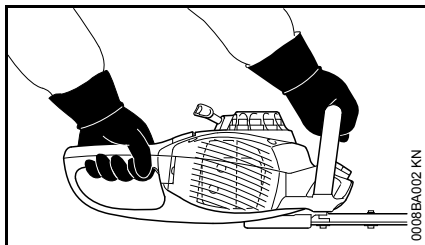

Left hand on the control handle and right hand on the front handle.

Make sure you have firm and secure footing and hold the power tool so that the cutting blades are always away from your body.

During Operation

In the event of impending danger or in an emergency, switch off the engine immediately – move the Master Control lever in the direction of **STOP** or ☺.

Check that there are no bystanders in the general work area.

Watch the cutting blades at all times – do not cut areas of the hedge that you cannot see.

Be extremely careful when cutting tall hedges, check the other side of the hedge before starting work.

Make sure the idle speed setting is correct. The cutting blades must not run when the engine is idling with the throttle trigger released.

If the cutting blades still run, have your dealer check your machine and make proper adjustments or repairs. Check and correct the idle speed setting regularly.

Note that the cutting blades continue to run for a short period after you let go of the throttle trigger – **flywheel effect**.

The gearbox becomes hot during operation. **To reduce the risk of burn injury**, do not touch the gearbox housing.

Take special care in slippery conditions (ice, wet ground, snow), on slopes or uneven ground.

Clear away fallen branches, scrub and cuttings.

Watch out for obstacles: Roots, tree stumps or holes which **could cause you to trip or stumble**.

Make sure you always have good balance and secure footing.

When working at heights:

- Always use a lift bucket
- Never work on a ladder or in a tree
- Never work on an insecure support
- Never operate your power tool with one hand

Be particularly alert and cautious when wearing hearing protection because your ability to hear warnings (shouts, alarms, etc.) is restricted.

To reduce the risk of accidents, take a break in good time to avoid tiredness or exhaustion.

Work calmly and carefully – in daylight conditions and only when visibility is good. Stay alert so as not to endanger others.



Your power tool produces toxic exhaust fumes as soon as the engine is running. These fumes may be colorless and odorless and contain unburned hydrocarbons and benzol. Never run the engine indoors or in poorly ventilated locations, even if your model is equipped with a catalytic converter.

To reduce the risk of serious or fatal injury from breathing toxic fumes, ensure proper ventilation when working in trenches, hollows or other confined locations.

To reduce the risk of accidents, stop work immediately in the event of nausea, headache, visual disturbances (e.g. reduced field of vision), problems with hearing, dizziness, deterioration in ability to concentrate. Apart from other possibilities, these symptoms may be caused by an excessively high concentration of exhaust gases in the work area.

Operate your power tool so that it produces a minimum of noise and emissions – do not run the engine unnecessarily, accelerate the engine only when working.

To reduce the risk of fire, do not smoke while operating or standing near your power tool. Note that combustible fuel vapor may escape from the fuel system.

If your power tool is subjected to unusually high loads for which it was not designed (e.g. heavy impact or a fall), always check that it is in good condition before continuing work – see also "Before Starting". Check the fuel system in particular for leaks and make sure the safety devices are working properly. Do not continue operating your power tool if it is damaged. In case of doubt, consult your servicing dealer.

Do not operate your power tool in the starting throttle position – engine speed cannot be controlled in this position.

Inspect the hedge and work area to avoid damaging the cutting blades:

- Remove stones, rocks, pieces of metal and other solid objects.
- When working close to the ground, make sure that no sand, grit or stones get between the blades.
- Take particular care when cutting hedges next to or against wire fences.

To avoid the risk of electrocution, do not touch electric power lines – never cut through electric power lines.



Do not touch the cutting blades while the motor is running. If the cutting blades become jammed by thick branches or other obstructions, switch off the engine immediately before attempting to free the blades – **there is otherwise a risk of injury**.

Opening the throttle while the blades are blocked increases the load and reduces engine speed. The clutch then slips continuously and this causes overheating and damage to important components (e.g. clutch, polymer housing components) – and **this can increase the risk of injury** from the cutting blades moving while the engine is idling.

If the hedge is very dusty or dirty, spray the blades with STIHL resin solvent from time to time during cutting. This helps reduce blade friction as well as the aggressive effects of sap and the build-up of dirt particles.

The dust that occurs during operation may be harmful to health. If dust levels are very high, wear a suitable respirator.

Before leaving the power tool unattended: Shut off the engine.

Check the cutting blades at regular short intervals during operation or immediately if there is a noticeable change in cutting behavior:

- Shut off the engine.
- Wait until the cutting blades have come to a complete standstill.
- Check condition and tightness, look for cracks.
- Check sharpness.

To reduce the risk of fire, always clean plant residue, chips, leaves and excess lubricant off the engine and muffler.

After Finishing Work

Always clean dust and dirt off the machine – do not use any grease solvents for this purpose.

Spray the blades with STIHL resin solvent. Run the engine briefly so that the solvent is evenly distributed.

Vibrations

Prolonged use of the power tool may result in vibration-induced circulation problems in the hands (whitefinger disease).

No general recommendation can be given for the length of usage because it depends on several factors.

The period of usage is prolonged by:

- Hand protection (wearing warm gloves)
- Work breaks

The period of usage is shortened by:

- Any personal tendency to suffer from poor circulation (symptoms: frequently cold fingers, tingling sensations).
- Low outside temperatures.
- The force with which the handles are held (a tight grip restricts circulation).

Continual and regular users should monitor closely the condition of their hands and fingers. If any of the above symptoms appear (e.g. tingling sensation in fingers), seek medical advice.

Maintenance and Repairs

Service the machine regularly. Do not attempt any maintenance or repair work not described in the instruction manual. Have all other work performed by a servicing dealer.

STIHL recommends that you have servicing and repair work carried out exclusively by an authorized STIHL servicing dealer. STIHL dealers are regularly given the opportunity to attend training courses and are supplied with the necessary technical information.

Only use high-quality replacement parts in order to avoid the risk of accidents and damage to the power tool. If you have any questions in this respect, consult a servicing dealer.

STIHL recommends the use of original STIHL replacement parts. They are specifically designed to match your model and meet your performance requirements.

To reduce the risk of injury, **always shut off the engine** before carrying out any maintenance or repairs or cleaning the machine. – Exception: Carburetor and idle speed adjustments.

Do not turn the engine over on the starter with the spark plug boot or spark plug removed since there is otherwise a **risk of fire** from uncontained sparking.

To reduce the **risk of fire**, do not service or store your machine near open flames.

Check the fuel filler cap for leaks at regular intervals.

Use only a spark plug of the type approved by STIHL and make sure it is in good condition – see "Specifications".

Inspect the ignition lead (insulation in good condition, secure connection).

Check the condition of the muffler.

To reduce the risk of fire and damage to hearing, do not operate your machine if the muffler is damaged or missing.

Do not touch a hot muffler since **burn injury** will result.

Vibration behavior is influenced by the condition of the AV elements – check the AV elements at regular intervals.

Using the Unit

Cutting Season

Observe country-specific or municipal rules and regulations for cutting hedges.

Do not use your power tool during other people's rest periods.

Cutting Sequence

Use lopping shears or a chain saw to cut out thick branches first.

Cut both sides of the hedge first, then the top.

Disposal

Do not throw cuttings into the garbage can – they can be composted!

Working Technique

Vertical cut

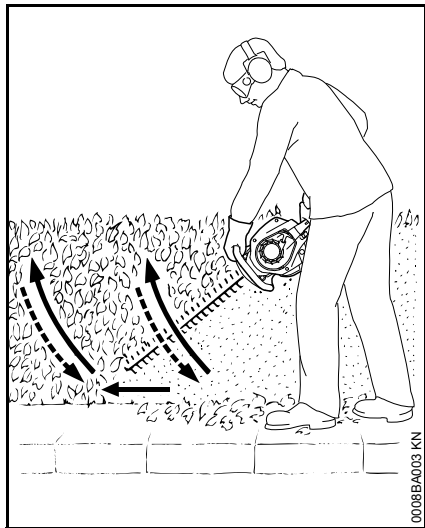

Swing the cutting blade from the bottom upwards in an arc – lower the nose of the blade, move along the hedge and then swing the blade up again in an arc.

Any working position above head height is tiring. To minimize the risk of accidents, work in such positions for short periods only.

Horizontal cut

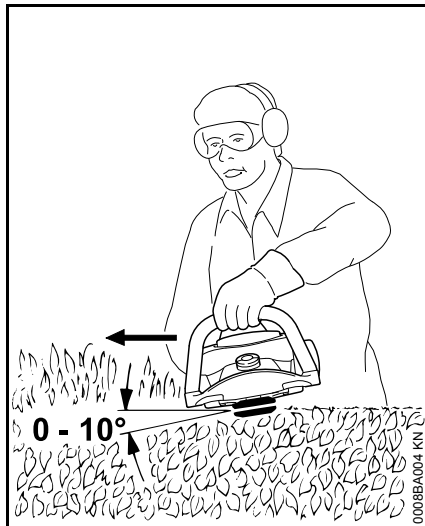

Hold the cutter bar at an angle of 0° to 10° as you swing the hedge trimmer horizontally.

Swing the cutting blade in an arc towards the outside of the hedge so that the cuttings are swept to the ground.

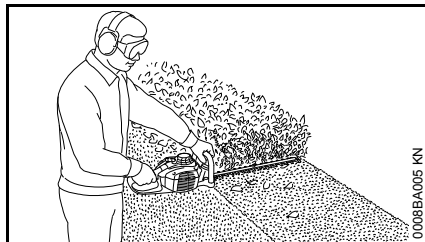

Repeat the procedure several times on wide hedges.

Fuel

Your engine requires a mixture of gasoline and engine oil.

WARNING

For health reasons, avoid direct skin contact with gasoline and avoid inhaling gasoline vapor.

STIHL MotoMix

STIHL recommends the use of STIHL MotoMix. This ready-to-use fuel mix contains no benzol or lead, has a high octane rating and ensures that you always use the right mix ratio.

STIHL MotoMix uses STIHL HP Ultra two-stroke engine oil for an extra long engine life.

MotoMix is not available in all markets.

Mixing Fuel

NOTICE

Unsuitable fuels or lubricants or mix ratios other than those specified may result in serious damage to the engine. Poor quality gasoline or engine oil may damage the engine, sealing rings, hoses and the fuel tank.

Gasoline

Use only high-quality **brand-name** gasoline with a minimum octane rating of 90 – leaded or unleaded.

Gasoline with an ethanol content of more than 10% can cause running problems in engines with a manually adjustable carburetor and should not be used in such engines.

Engines equipped with M-Tronic deliver full power when run on gasoline with an ethanol content of up to 25% (E25).

Engine Oil

If you mix the fuel yourself, use only STIHL two-stroke engine oil or another high-performance engine oil in accordance with JASO FB, JASO FC, JASO FD, ISO-L-EGB, ISO-L-EGC or ISO-L-EGD.

STIHL specifies STIHL HP Ultra two-stroke engine oil or an equivalent high-performance engine oil in order to maintain emission limits over the machine's service life.

Mix Ratio

STIHL 50:1 two-stroke engine oil: 50 parts gasoline to 1 part oil

Examples

Gasoline Liters	STIHL engine oil 50:1 Liters (ml)	
1	0.02	(20)
5	0.10	(100)
10	0.20	(200)
15	0.30	(300)
20	0.40	(400)
25	0.50	(500)

- Use a canister approved for storing fuel. Pour oil into canister first, then add gasoline and mix thoroughly.

Storing Fuel

Store fuel only in approved safety-type fuel canisters in a dry, cool and safe location protected from light and the sun.

Fuel mix ages – only mix sufficient fuel for a few weeks work. Do not store fuel mix for longer than 30 days. Exposure to light, the sun, low or high temperatures can quickly make the fuel mix unusable.

STIHL MotoMix may be stored for up to 2 years without any problems.

- Thoroughly shake the mixture in the canister before fueling your machine.

WARNING

Pressure may build up in the canister – open it carefully.

- Clean the fuel tank and canister from time to time.

Dispose of remaining fuel and cleaning fluid properly in accordance with local regulations and environmental requirements.

Fueling



Preparations

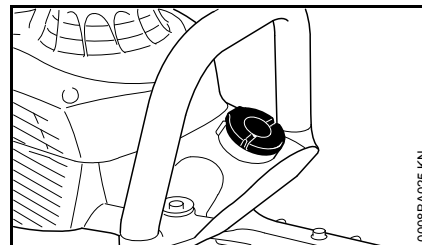

- Before fueling, clean the filler cap and the area around it to ensure that no dirt falls into the tank.
- Position the machine so that the filler cap faces up.

Opening

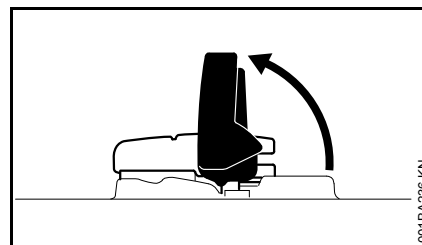

- Raise grip to vertical position.

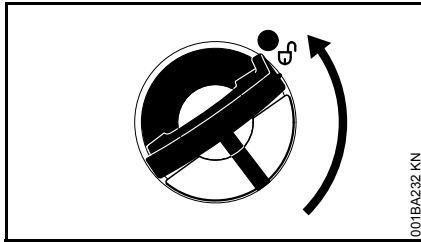

- Turn the cap counterclockwise (about a quarter turn).

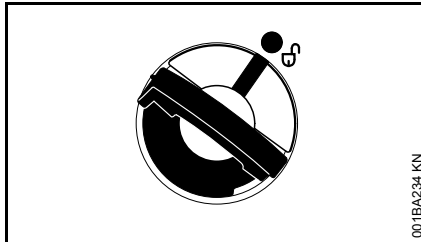

Marks on tank cap and fuel tank must line up.

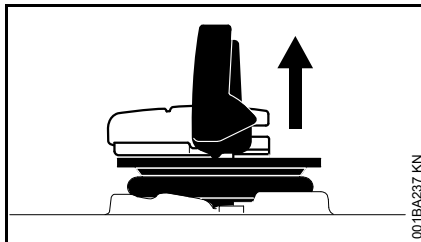

- Remove the tank cap.

Filling Up with Fuel

Take care not to spill fuel while fueling and do not overfill the tank.

STIHL recommends you use the STIHL filler nozzle for fuel (special accessory).

- Fill the fuel tank.

Closing

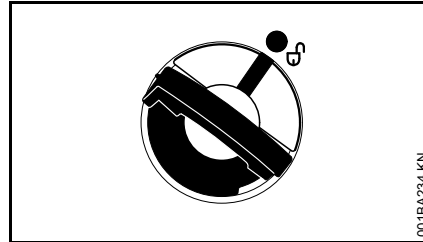

Grip must be vertical:

- Fit the cap – marks on tank cap and fuel tank must line up.
- Press the cap down as far as stop.

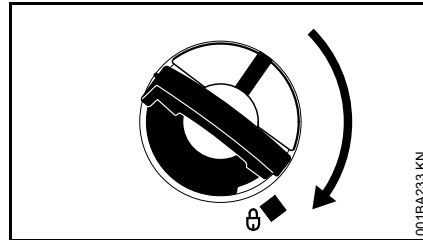

- While holding the cap depressed, turn it clockwise until it engages in position.

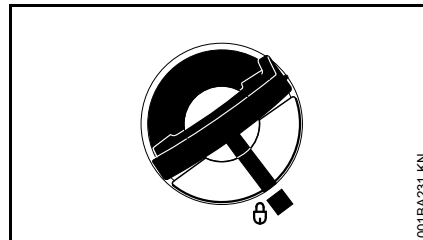

The marks on the tank cap and fuel tank are then in alignment.

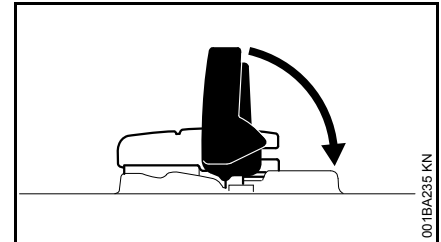

- Fold the grip down.

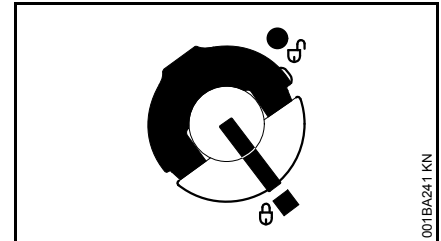

Tank cap is locked.

If the tank cap cannot be locked in the fuel tank opening

Bottom of cap is twisted in relation to top.

- Remove the cap from the fuel tank and check it from above.

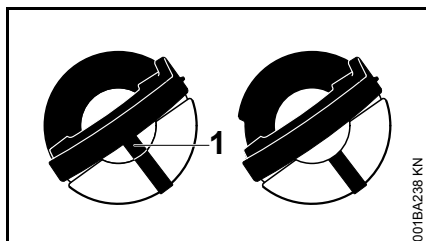

- Left: Bottom of cap is twisted – inner mark (1) in line with outer mark.
- Right: Bottom of cap in correct position – inner mark is under the grip. It is not in line with the outer mark.

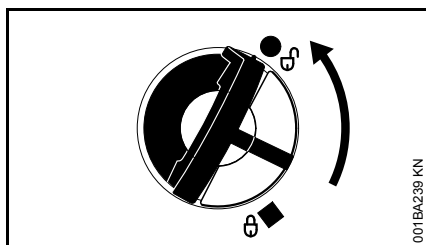



- Place the cap on the opening and rotate it counterclockwise until it engages the filler neck.
- Continue rotating the cap counterclockwise (about a quarter turn) – this causes the bottom of the cap to be turned to the correct position.
- Turn the cap clockwise and lock it in position – see section on "Closing".

Starting / Stopping the Engine

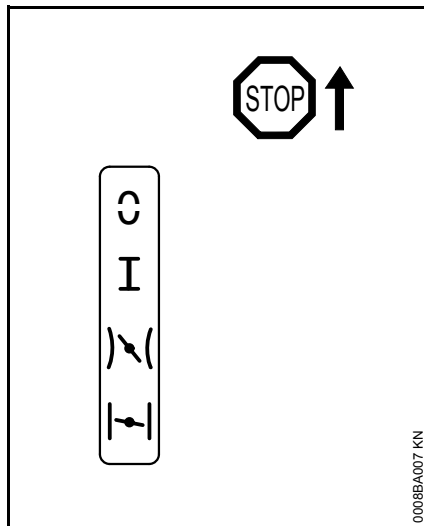
Positions and Functions of Master Control Lever



STOP or  – Master Control lever must be pushed in direction of **STOP** or  to switch off the ignition. When released, the Master Control lever springs back to the normal run position **I** and the ignition is switched on again.



Normal run position I – engine runs or can fire.



Starting throttle  – this position is used to start a warm engine. The Master Control lever moves to the normal run position **I** when the throttle trigger is squeezed.

Choke closed  – this position is used to start a cold engine. The Master Control lever moves to the normal run position **I** when the throttle trigger is squeezed.

Setting the Master Control Lever

To move the Master Control lever from the normal run position **I** to choke closed , press down the throttle trigger lockout and squeeze the throttle trigger at the same time and hold them in that position – now set the Master Control lever.

To select the starting throttle position , move the Master Control lever to choke closed  first, then push it into the starting throttle position .

The Master Control lever moves from the starting throttle position  or choke closed position  to the normal run position **I** when you press down the throttle trigger lockout and blip the throttle trigger at the same time.

To switch off the engine, move the Master Control lever in the direction of **STOP** or  – when released, the Master Control lever springs back to the normal run position **I**.

Start the engine.

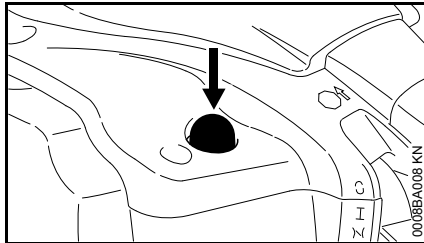

- Press the manual fuel pump bulb at least five times – even if the bulb is filled with fuel.
- Set the Master Control lever to suit the engine temperature.

Cold engine (cold start)

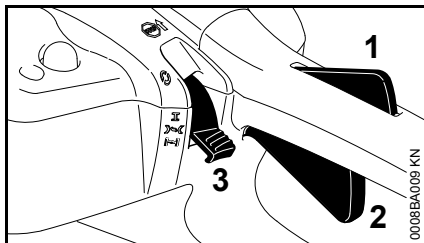

- Depress the throttle trigger lockout (1) and the throttle trigger (2) at the same time – hold both levers in that position.
- Move the Master Control lever (3) to .
- Release the throttle trigger lockout (1), throttle trigger (2) and Master Control lever.

Warm engine (warm start)

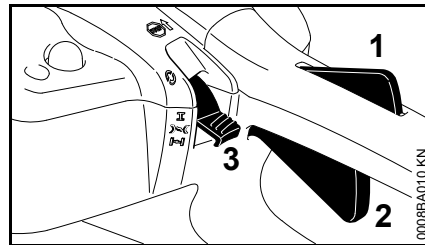

- Depress the throttle trigger lockout (1) and the throttle trigger (2) at the same time – hold both levers in that position.
- Move the Master Control lever (3) to .
- Release the throttle trigger lockout (1), throttle trigger (2) and Master Control lever.

Also use this setting if the engine has been running but is still cold.

Starting

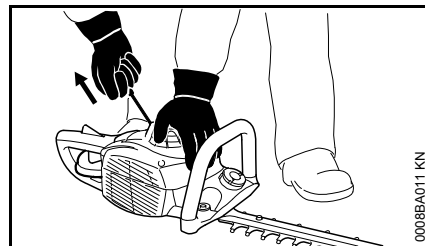

- Place the unit on the ground.
- Remove the blade scabbard. Check that the cutting blades are not touching the ground or any other obstacles.

- Make sure you have a safe and secure footing.
- Hold the unit firmly with your left hand on the fan housing and press down.
- Hold the starter grip with your right hand.

Version without ErgoStart

- Pull the starter grip slowly until you feel it engage and then give it a brisk strong pull.



NOTICE

Do not pull out the starter rope all the way – **it might otherwise break.**

- Do not let the starter grip snap back. Guide it slowly back into the housing so that the starter rope can rewind properly.

Version with ErgoStart

- Pull the starter grip steadily.

As soon as the engine runs

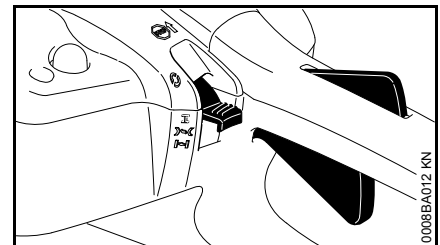

- Press down the throttle trigger lockout and open the throttle – the Master Control lever moves to the

run position I. After a cold start, warm up the engine by opening the throttle several times.

! WARNING

Make sure the carburetor is correctly adjusted. The cutting attachment must not rotate when the engine is idling.

Your machine is now ready for operation.

Stopping the Engine

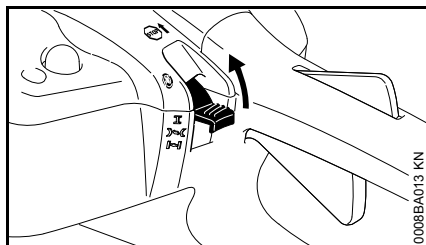

- Move the Master Control lever in the direction of **STOP** or II – when released, the Master Control lever springs back to the normal run position I.

Other hints on starting

Engine stalls in cold start position II or under acceleration

- Move the Master Control lever to II and continue cranking until the engine runs.

Engine does not start in warm start position III.

- Move the Master Control lever to III and continue cranking until the engine runs.

If the engine does not start

- Check that all settings are correct.
- Check that there is fuel in the tank and refuel if necessary.
- Check that the spark plug boot is properly connected.
- Repeat the starting procedure.

Fuel tank run until completely dry

- After refueling, press the manual fuel pump bulb at least five times – even if the bulb is filled with fuel.
- Set the Master Control lever to suit the engine temperature.
- Start the engine.

Operating Instructions

During break-in period

A factory-new machine should not be run at high revs (full throttle off load) for the first three tank fillings. This avoids unnecessary high loads during the break-in period. As all moving parts have to bed in during the break-in period, the frictional resistances in the engine are greater during this period. The engine develops its maximum power after about 5 to 15 tank fillings.

During Operation

After a long period of full throttle operation, allow the engine to run for a short while at idle speed so that engine heat can be dissipated by the flow of cooling air. This protects engine-mounted components (ignition, carburetor) from thermal overload.

After Finishing Work

Storing for a short period: Wait for the engine to cool down. Empty the fuel tank and keep the machine in a dry place, well away from sources of ignition, until you need it again. For longer out-of-service periods – see "Storing the Machine".

Cleaning the Air Filter

If there is a noticeable loss of engine power

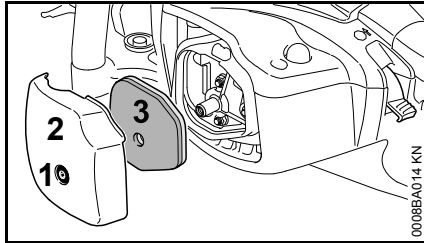

- Loosen the captive screw (1) and remove the filter cover (2).
- Clean away loose dirt from around the filter.
- Remove the filter element (3).
- Fit a new filter element. As a temporary measure you can knock it out on the palm of your hand or blow it out with compressed air. Do not wash.
- Replace any damaged parts.
- Fit the filter element (3).
- Fit the filter cover (2) and screw it down firmly.

Adjusting the Carburetor

General Information

The carburetor comes from the factory with a standard setting.

This setting provides an optimum fuel-air mixture under most operating conditions.

Standard Setting

- Shut off the engine.
- Inspect cutting blades and clean if necessary (clean, move freely, not warped).
- Check the air filter and clean or replace if necessary.

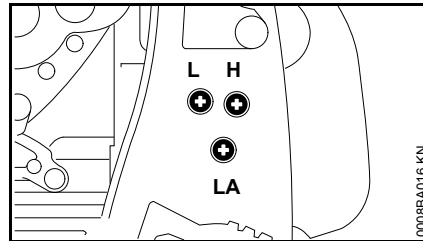

- Turn high speed screw (H) counterclockwise as far as stop (no more than 3/4 turn).
- Turn the low speed screw (L) carefully clockwise as far as stop, then turn it back 3/4 turn.

Adjusting Idle Speed

- Carry out the standard setting.
- Start and warm up the engine.

Engine stops while idling

- Turn the idle speed screw (LA) clockwise until the cutting blades begin to run – then back it off about 1 full turn.

Cutting blades run when engine is idling

- Turn the idle speed screw (LA) counterclockwise until the cutting blades stop moving – then turn it another 1 full turn in the same direction.

WARNING

If the cutting blades continue moving when the engine is idling, have your hedge trimmer checked and repaired by your servicing dealer.

Erratic idling behavior, poor acceleration (despite correction to setting of LA screw).

Idle setting is too lean

- Rotate the low speed screw (L) about 1/4 turn counterclockwise, no further than stop, until the engine runs and accelerates smoothly.

Machine stops when it is swung at idle speed

Idle setting is too rich

- Rotate the low speed screw (L) about 1/4 turn clockwise until the engine idles smoothly.

It is usually necessary to change the setting of the idle speed screw (LA) after every correction to the low speed screw (L).

Fine Tuning for Operation at High Altitude

A slight correction of the setting may be necessary if engine does not run satisfactorily:

- Carry out the standard setting.
- Warm up the engine.
- Turn high speed screw (H) slightly clockwise (leaner) – no further than stop.



NOTICE

After returning from high altitude, reset the carburetor to the standard setting.

If the setting is too lean there is a risk of engine damage due to insufficient lubrication and overheating.

Checking the Spark Plug

- If the engine is down on power, difficult to start or runs poorly at idle speed, first check the spark plug.
- Fit a new spark plug after about 100 operating hours – or sooner if the electrodes are badly eroded. Install only suppressed spark plugs of the type approved by STIHL – see "Specifications".

Removing the Spark Plug

- Stopping the Engine

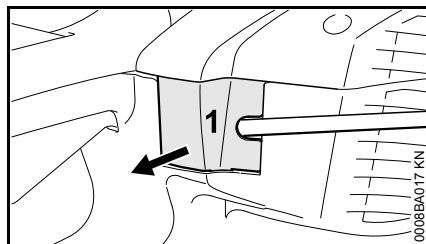

- Carefully pry open the flap (1) with a suitable tool (e.g. combination wrench).

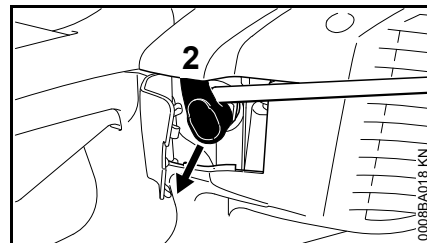

- Remove the spark plug boot (2) using a suitable tool (e.g. combination wrench).
- Unscrew the spark plug.

Checking the Spark Plug

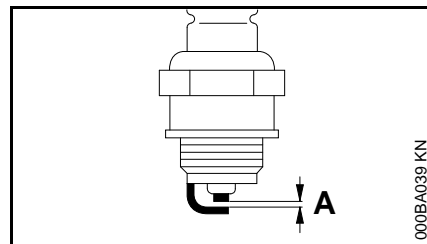

- Clean dirty spark plug.
- Check electrode gap (A) and readjust if necessary – see "Specifications".
- Rectify the problems which have caused fouling of the spark plug.

Possible causes are:

- Too much oil in fuel mix.
- Dirty air filter.
- Unfavorable running conditions.

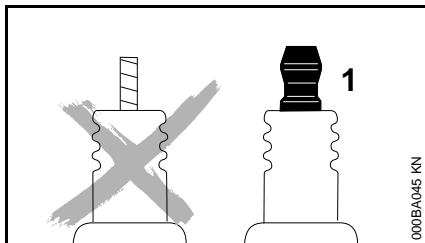

! WARNING

Arcing may occur if the adapter nut (1) is loose or missing. Working in an easily combustible or explosive atmosphere may cause a fire or an explosion. This can result in serious injuries or damage to property.

- Use resistor type spark plugs with a properly tightened adapter nut.

Installing the Spark Plug

- Insert and screw home the spark plug by hand.
- Tighten down the spark plug.
- Press the spark plug boot **firmly** onto the spark plug.

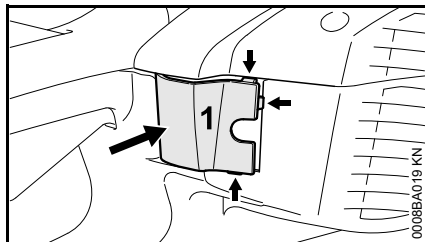

- Close the flap (1), top first, then the bottom, tabs (arrows) must snap into position.

Lubricating the Gearbox

Commercial usage only – check every 25 hours of operation

HS 46

Use STIHL gear lubricant for hedge trimmers (special accessory) to lubricate the blade drive gear.

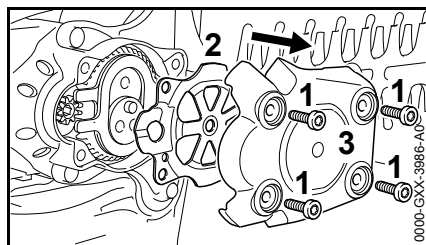

- Remove the screws (1) from the underside of the unit.
- Remove the retaining plate (2) and gear cover (3).

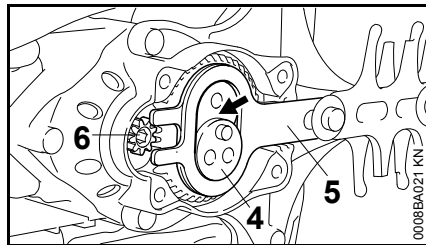

- Squeeze grease into the gearbox housing (arrow) between the cam (4) and cutting blade (5) a little at a time (max. 5 g (1/5 oz)) while turning the drive pinion (6) with a

hex key to distribute the grease evenly – **avoid contact with the cutting blades.**

⚙ NOTICE

Do not completely fill the gearbox with grease.

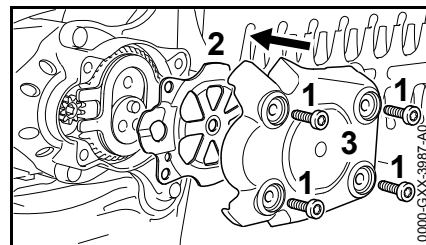

- Fit the retaining plate (2) so that it is flush with the gearbox housing.
- Fit the gear cover (3), insert the screws (1) and tighten them down firmly.

HS 56

Use STIHL gear lubricant for hedge trimmers (special accessory) to lubricate the blade drive gear.

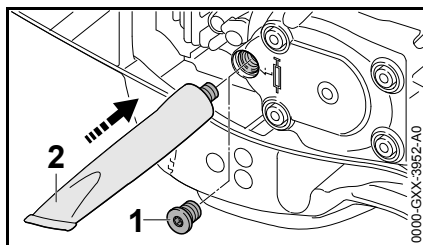

- Unscrew the filler plug (1). If no grease can be seen on the inside of the filler plug, screw the tube (2) of STIHL gear lubricant (special accessory) into the filler hole.
- Squeeze up to 5 g (1/5 oz) grease into the gearbox.

**NOTICE**

Do not completely fill the gearbox with grease.

- Unscrew the tube of grease from the filler hole.
- Refit the filler plug and tighten it down firmly.

Storing the Machine

For periods of 3 months or longer

- Clean the cutting blades, check condition and spray them with STIHL resin solvent.
- Drain and clean the fuel tank in a well ventilated area.
- Dispose of fuel properly in accordance with local environmental requirements.
- Run the engine until the carburetor is dry – this helps prevent the carburetor diaphragms sticking together.
- Fit the blade scabbard.
- Thoroughly clean the machine – pay special attention to the cylinder fins and air filter.
- Store the machine in a dry and safe location (use the ring integrated in the rear handle) – out of the reach of children and other unauthorized persons.

Sharpening Instructions

When cutting performance and behavior begin to deteriorate, i.e. blades frequently snag on branches: Resharpener the cutting blades.

It is best to have the cutting blades resharpened by a dealer on a workshop sharpener. STIHL recommends a STIHL servicing dealer.

It is also possible to use a flat crosscut sharpening file. Hold the sharpening file at the prescribed angle (see "Specifications").

- Only sharpen the cutting edge – do not file blunt projecting parts of the cutting blade or the cutting blade guard (see "Main Parts and Controls")
- Always file towards the cutting edge.
- The file only sharpens on the forward stroke – lift it off the blade on the backstroke.
- Use a whetstone to remove burr from cutting edge.
- Remove as little material as possible.
- After sharpening, clean away filing or grinding dust and then spray the cutting blades with STIHL resin solvent.

**NOTICE**

Do not operate your machine with dull or damaged cutting blades. This may cause overload and will give unsatisfactory cutting results.

Maintenance and Care

The following intervals apply to normal operating conditions only. If your daily working time is longer or operating conditions are difficult (very dusty work area, etc.), shorten the specified intervals accordingly.		before starting work	after finishing work or daily	after each refueling stop	weekly	monthly	every 12 months	if problem	if damaged	as required
Complete machine	Visual inspection (condition, leaks)	X		X						
	Clean		X							
Control handle	Check operation	X		X						
Air filter	Clean							X		X
	Replace								X	
Manual fuel pump (if fitted)	Check	X								
	Have repaired by servicing dealer ¹⁾								X	
Pickup body in fuel tank	Have checked by servicing dealer ¹⁾							X		
	Have replaced by servicing dealer ¹⁾						X		X	X
Fuel tank	Clean							X		X
Carburetor	Check idle adjustment	X		X						
	Readjust idle									X
Spark plug	Readjust electrode gap							X		
	Replace after every 100 operating hours									
Cooling inlets	Visual inspection		X							
	Clean									X
All accessible screws and nuts (not adjusting screws)	Tighten									X
Anti-vibration elements	Visual inspection	X								
	Have replaced by servicing dealer ¹⁾							X	X	

The following intervals apply to normal operating conditions only. If your daily working time is longer or operating conditions are difficult (very dusty work area, etc.), shorten the specified intervals accordingly.		before starting work	after finishing work or daily	after each refueling stop	weekly	monthly	every 12 months	if problem	if damaged	as required
Cutting blades	Clean		X							
	Sharpen ¹⁾									X
	Visual inspection	X								
	Have replaced by servicing dealer ¹⁾								X	
Gearbox lubrication	commercial use only – check every 25 hours of operation and replenish with STIHL gear lubricant if necessary									
Safety labels	Replace								X	

¹⁾ STIHL recommends an authorized STIHL servicing dealer

Minimize Wear and Avoid Damage

Observing the instructions in this manual helps reduce the risk of unnecessary wear and damage to the power tool.

The power tool must be operated, maintained and stored with the due care and attention described in this owner's manual.

The user is responsible for all damage caused by non-observance of the safety precautions, operating and maintenance instructions in this manual. This includes in particular:

- Alterations or modifications to the product not approved by STIHL.
- Using tools or accessories which are neither approved or suitable for the product or are of a poor quality.
- Using the product for purposes for which it was not designed.
- Using the product for sports or competitive events.
- Consequential damage caused by continuing to use the product with defective components.

Maintenance Work

All the operations described in the "Maintenance Chart" must be performed on a regular basis. If these maintenance operations cannot be performed by the owner, they should be performed by a servicing dealer.

STIHL recommends that you have servicing and repair work carried out exclusively by an authorized STIHL

servicing dealer. STIHL dealers are regularly given the opportunity to attend training courses and are supplied with the necessary technical information.

If these maintenance operations are not carried out as specified, the user assumes responsibility for any damage that may occur. Among other parts, this includes:

- Damage to the engine due to neglect or deficient maintenance (e.g. air and fuel filters), incorrect carburetor adjustment or inadequate cleaning of cooling air inlets (intake ports, cylinder fins).
- Corrosion and other consequential damage resulting from improper storage.
- Damage to the machine resulting from the use of poor quality replacement parts.

Parts Subject to Wear and Tear

Some parts of the power tool are subject to normal wear and tear even during regular operation in accordance with instructions and, depending on the type and duration of use, have to be replaced in good time. Among other parts, this includes:

- Cutting blades
- Clutch
- Filters (air, fuel)
- Rewind starter
- Spark plug
- Components of antivibration system

Main Parts

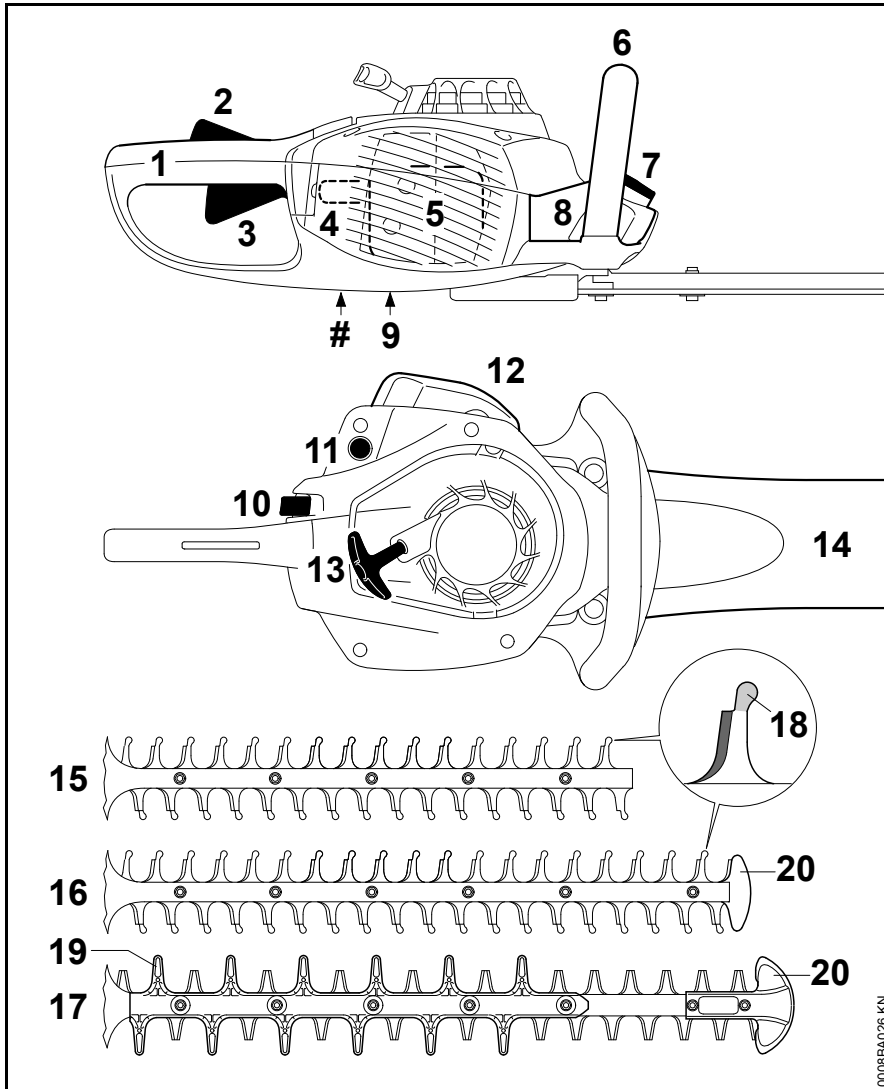

- 1 Control handle
- 2 Throttle trigger lockout
- 3 Throttle trigger
- 4 Spark plug boot
- 5 Muffler
- 6 Front handle
- 7 Fuel filler cap
- 8 Fuel tank
- 9 Carburetor adjusting screws
- 10 Master Control lever
- 11 Manual fuel pump
- 12 Filter cover
- 13 Starter grip
- 14 Blade scabbard
- 15 Cutting blades (HS 46)
- 16 Cutting blades (HS 46 C)
- 17 Cutting blades (HS 56 C)
- 18 Blunt projection (integral cutter guard)
- 19 Cutter guard
- 20 Tip guard
- # Serial number

Specifications

Engine

STIHL single cylinder two-stroke engine

Displacement:	21.4 cm ³
Bore:	33 mm
Stroke:	25 mm
Engine power to ISO 7293:	0.65 kW (0.9 HP) at 8,500 rpm
Idle speed:	2,750 rpm
Engine cut-off speed:	9,300 rpm

Ignition System

Electronic magneto ignition

Spark plug (resistor type):	NGK CMR6H, BOSCH USR4AC
Electrode gap:	0.5 mm

Fuel System

All position diaphragm carburetor with integral fuel pump

Fuel tank capacity:	280 cc (0.28 l)
---------------------	-----------------

Cutting blades

HS 46

Bidirectional, ground on one side	
Sharpening angle:	35°

Tooth spacing:	30 mm
Stroke rate:	3,600/min
Cutting length:	450 mm

HS 46 C

Bidirectional, ground on one side	
Sharpening angle:	35°
Tooth spacing:	30 mm
Stroke rate:	3,600/min
Cutting length:	550 mm

HS 56 C

Bidirectional, ground on both sides	
Sharpening angle:	45°
Tooth spacing:	34 mm
Stroke rate:	3,600/min
Cutting length:	600 mm

Weight

complete with cutting attachment, dry

HS 46

450 mm blade:	4.0 kg
---------------	--------

HS 46 C

550 mm blade:	4.3 kg
---------------	--------

HS 56 C

600 mm blade:	4.5 kg
---------------	--------

Noise and Vibration Data

Noise and vibration data are measured at idling and maximum rated speed in a ratio of 1:4.

For further details on compliance with Vibration Directive 2002/44/EC see www.stihl.com/vib/

Sound pressure level L_{peq} to ISO 10517 (ISO 11201)

HS 46:	95 dB(A)
HS 46 C:	95 dB(A)
HS 56 C:	95 dB(A)

Sound power level L_w to ISO 10517 (ISO 3744)

HS 46:	107 dB(A)
HS 46 C:	107 dB(A)
HS 56 C:	107 dB(A)

Vibration measurement $a_{hv,eq}$ to ISO 10517

HS 46

Left handle:	4.5 m/s ²
Right handle:	4.9 m/s ²

HS 46 C

Left handle:	4.5 m/s ²
Right handle:	4.9 m/s ²

HS 56 C

Left handle:	4.7 m/s ²
Right handle:	5.5 m/s ²

The K-factor in accordance with Directive 2006/42/EC is 2.0 dB(A) for the sound pressure level and sound power level; the K-factor in accordance with Directive 2006/42/EC is 2.0 m/s² for the vibration level.

REACH

REACH is an EC regulation and stands for the Registration, Evaluation, Authorisation and Restriction of Chemical substances.

For information on compliance with the REACH regulation (EC) No. 1907/2006 see www.stihl.com/reach.

Exhaust Emissions

The CO₂ value measured in the EU type approval procedure is specified at www.stihl.com/co2.

The measured CO₂ value was determined on a representative engine in accordance with a standardized test procedure under laboratory conditions and does not represent either an explicit or implied guarantee of the performance of a specific engine.

The applicable exhaust emission requirements are fulfilled by the intended usage and maintenance described in this instruction manual. The type approval expires if the engine is modified in any way.

Maintenance and Repairs

Users of this machine may only carry out the maintenance and service work described in this user manual. All other repairs must be carried out by a servicing dealer.

STIHL recommends that you have servicing and repair work carried out exclusively by an authorized STIHL servicing dealer. STIHL dealers are regularly given the opportunity to attend training courses and are supplied with the necessary technical information.

When repairing the machine, only use replacement parts which have been approved by STIHL for this power tool or are technically identical. Only use high-quality replacement parts in order to avoid the risk of accidents and damage to the machine.

STIHL recommends the use of original STIHL replacement parts.

Original STIHL parts can be identified by the STIHL part number, the **STIHL** logo and the STIHL parts symbol  (the symbol may appear alone on small parts).

Disposal

Observe all country-specific waste disposal rules and regulations.

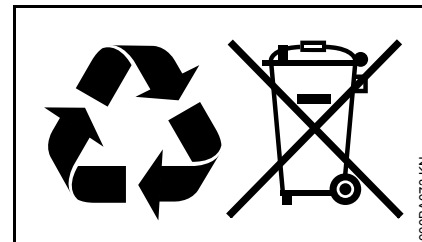

STIHL products must not be thrown in the garbage can. Take the product, accessories and packaging to an approved disposal site for environment-friendly recycling.

Contact your STIHL servicing dealer for the latest information on waste disposal.

EC Declaration of Conformity

ANDREAS STIHL AG & Co. KG
Badstr. 115
D-71336 Waiblingen

Germany

declare in exclusive responsibility that
the product

Category: Hedge trimmer
Make: STIHL
Model: HS 46
HS 46 C
HS 56 C

Serial identification: 4242
Displacement: 21.4 cc

conforms to the provisions of Directives
2011/65/EU, 2006/42/EC, 2014/30/EU
and 2000/14/EC and has been
developed and manufactured in
compliance with the following standards
in the versions valid at the time of
production:

EN ISO 10517, EN 55012,
EN 61000-6-1

The measured and guaranteed sound
power levels were determined according
to Directive 2000/14/EC, Annex V, using
the ISO 11094 standard.

Measured sound power level

105 dB(A)

Guaranteed sound power level

107 dB(A)

Technical documents deposited at:

ANDREAS STIHL AG & Co. KG
Produktzulassung (Product Licensing)

The year of manufacture and serial
number are applied to the product.

Done at Waiblingen, 28.11.2018

ANDREAS STIHL AG & Co. KG



Thomas Elsner

Director Product Management and
Services



0458-447-0121-B

englisch



www.stihl.com



0458-447-0121-B