

**STIHL**

# STIHL BT 45

Instruction Manual





## Contents

Guide to Using this Manual	2
Safety Precautions and Working Techniques	2
Mounting the Handles	7
Using the Unit	8
Fuel	10
Fueling	11
Gearbox	14
Fitting the Auger	15
Starting / Stopping the Engine	15
Operating Instructions	17
Releasing a Trapped Auger	18
Cleaning the Air Filter	18
Adjusting the Carburetor	19
Spark Plug	20
Engine Running Behavior	21
Storing the Machine	21
Maintenance and Care	22
Minimize Wear and Avoid Damage	23
Main Parts	24
Specifications	25
Maintenance and Repairs	26
Disposal	26
EC Declaration of Conformity	26

Dear Customer,

Thank you for choosing a quality engineered STIHL product.

It has been built using modern production techniques and comprehensive quality assurance. Every effort has been made to ensure your satisfaction and trouble-free use of the product.

Please contact your dealer or our sales company if you have any queries concerning this product.

Your



Dr. Nikolas Stihl



## Guide to Using this Manual

### Pictograms

---

The meanings of the pictograms attached to the machine are explained in this manual.

Depending on the model concerned, the following pictograms may be attached to your machine.



Fuel tank; fuel mixture of gasoline and engine oil

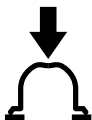

Operate manual fuel pump

### Symbols in text

---



#### WARNING

Warning where there is a risk of an accident or personal injury or serious damage to property.



#### NOTICE

Caution where there is a risk of damaging the machine or its individual components.

### Engineering improvements

---

STIHL's philosophy is to continually improve all of its products. For this reason we may modify the design, engineering and appearance of our products periodically.

Therefore, some changes, modifications and improvements may not be covered in this manual.

## Safety Precautions and Working Techniques



Special safety precautions must be taken when working with this machine due to the high torque and partly very high rotational speed of the drill and because the augers have sharp edges.



It is important you read and understand the User Manual before first use and keep it in a safe place for future reference. Non-compliance with the User Manual may cause serious or even fatal injury.

Observe all applicable local safety regulations, e.g. by trade organizations, social insurance institutions, labor safety authorities etc.

If you have never used a power tool before: Have your dealer or other experienced user show you how to operate your machine – or attend a special course to learn how to operate it.

Minors are not allowed to work with the power tool – except adolescents above 16 years of age who are instructed under supervision.

Children, animals and bystanders must not be allowed near the machine.

When not using the machine, it must be laid down in such a way that it does not endanger anyone. Ensure that the machine cannot be used without authorization.

The user is responsible for accidents or risks involving third parties or their property.

Do not lend or rent your power tool without the User Manual. Be sure that anyone using it understands the information contained in this manual.

The use of machines that emit noise may be limited to certain hours of the day as specified by national and/or regional or local regulations.

Anyone operating the machine must be well rested, in good physical health and in good mental condition.

If you have any condition that might be aggravated by strenuous work, check with your doctor before operating a machine.

If you have a pacemaker: The ignition system of your machine produces an electromagnetic field of very low intensity. This field may interfere with some pacemakers. STIHL recommends that persons with pacemakers consult their physician and the pacemaker manufacturer to reduce any health risk.

Anyone who has consumed alcohol or drugs or medicines affecting their ability to react must not operate a power tool.

Depending on the drilling tool and attachments mounted, use your power tool only for drilling holes in wood, holes for plants (shallow holes in loosened soil) or holes in ice.

It must not be used for any other purposes.

Before drilling, make sure that there are no lines (e. g. for gas, water, electricity) at the drilling sites:

- Obtain information from the local utility companies
- If in doubt, check the existence of lines with detectors or test excavations

Only use augers or accessories which have been approved by STIHL for this machine or which are technically equivalent. If you have any questions in this respect, consult your dealer. Use only high quality parts and accessories. In order to avoid the risk of accidents and damage to the machine.

STIHL recommends the use of original STIHL tools and accessories. They are specifically designed to match the product and meet your performance requirements.

Never attempt to modify your power tool in any way since this may increase the risk of personal injury. STIHL excludes all liability for personal injury and damage to property caused while using unauthorized attachments.

Do not use a high-pressure washer to clean the power tool. The solid jet of water may damage parts of the unit.

### Clothing and equipment

Wear proper protective clothing and equipment.



Clothing must be sturdy but allow complete freedom of movement. Wear close-fitting clothes such as a boiler suit, not a loose jacket.

Do not wear clothing which could become trapped in wood, brush or moving parts of the machine. Do not wear a scarf, necktie or jewelry.



Tie up and confine long hair above your shoulders.

Wear sturdy shoes with non-slip soles.



### **WARNING**



To reduce the risk of eye injuries, wear close-fitting safety glasses in accordance with European Standard EN 166. Make sure the safety glasses are a snug fit.

Wear hearing protection, e.g. ear defenders.



Wear sturdy protective gloves made of a resistant material (e. g. leather).

STIHL can supply a comprehensive range of personal protective equipment.

### Transporting the machine

Always stop the engine.

Carry the machine with the drilling tool pointing down – keep the hot muffler away from your body.

It is also possible to use a shoulder strap (special accessory).

By vehicle: When transporting in a vehicle, properly secure your machine to prevent turnover, damage and fuel spillage.

## Refueling

---



**Gasoline is highly flammable** – keep away from fire or flame – do not spill any fuel – no smoking.

Always **shut off the engine** before refueling.

Do not fuel a hot engine – **fuel may spill and cause a fire.**

Open the fuel cap carefully to allow any pressure build-up in the tank to release slowly and avoid fuel spillage.

Only refuel the machine in a well ventilated place. If fuel has been spilled, immediately clean the machine – do not allow your clothes to be splashed with fuel. If that happens, change your clothes at once.



Place the clip lock fuel cap (bayonet-type) in position, turn it until it will go no further and fold the clip lock down.



Check for fuel leakage while refueling and during operation. Never start the engine if fuel has been spilled or is leaking – **Fatal burns may result!**

## Before starting

---

Check that your power tool is properly assembled and in good condition – refer to appropriate chapters in the instruction manual.

- Check the fuel system for leaks, especially the visible parts, e. g., fuel cap, hose connections, manual fuel pump (only in machines with a manual fuel pump). In case of leakage and damage, do not start the engine – **risk of fire!** Have the machine serviced by a dealer before using it
- Slide control / stop switch must move easily to **STOP** or **0**
- Additional front assist handle properly mounted to suit drilling tool being used.
- Smooth action of throttle trigger and starting throttle lock – throttle trigger must return automatically to idle position.
- Check that the spark plug boot is secure – a loose boot may cause arcing that could ignite combustible fumes **and cause a fire!**

- Never attempt to modify the controls or safety devices
- Keep the handles dry and clean – free from oil and dirt – this is important for safe control of the machine

**To reduce the risk of personal injury**, do not operate your power tool if it is damaged or not properly assembled!

## Starting the engine

---

Start the engine at least 3 meters from the fueling spot, outdoors only.

Place the machine on a flat surface and ensure a firm and safe footing, hold the machine firmly. The auger must not touch any objects or the ground because it may begin to rotate when the machine is started.

Gearbox in neutral – knob in **N**.position.

The machine is operated by a single person only – do not allow any person to stay within the working area – nor with starting. **To reduce the risk of injury**, avoid contact with the drilling tool.

Do not drop-start the engine – start it as described in the User Manual.

Check idle speed setting: The drilling tool must not rotate when the engine is idling with the throttle trigger released.

Keep easily combustible materials (e.g., wood chips, bark, dry grass, fuel) away from hot exhaust gases and the hot muffler surface – **risk of fire!**

## Holding and guiding the machine

Always hold the unit firmly with both hands on the handles.

Make sure you always have good balance and secure footing.

Wrap your fingers and thumbs around the handles. Right hand on control handle, left hand on the assist handle, even if you are left-handed.

## Drilling planting holes and ice holes

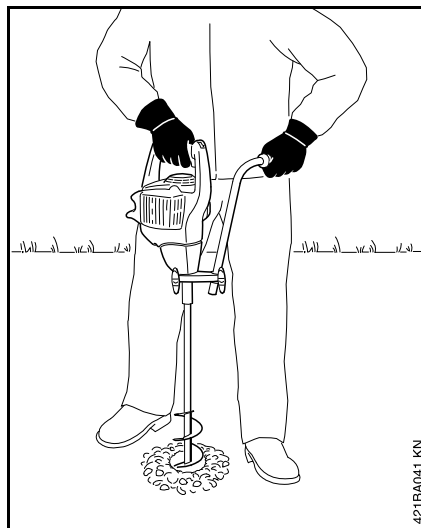

## Drilling holes in wood

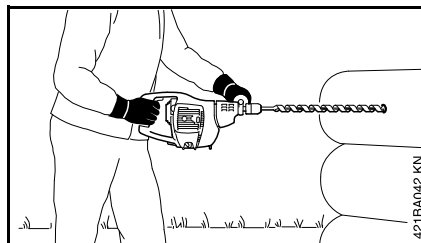

## While working

In the event of impending danger or in an emergency, switch off the engine immediately by moving the slide control / stop switch to **0** or **STOP**.

Do not allow any other persons in the work area. **To reduce the risk of injury**, keep a sufficiently safe distance away from other persons.

Check for correct idling, so that the auger stops turning when the throttle trigger is released. If the drilling tool continues to rotate when the engine is idling, have the machine checked by your servicing dealer. Check and correct the idle speed setting at regular intervals.

Take special care in slippery conditions – **damp, snow, ice**, on slopes or uneven ground.

Watch out for obstacles: tree stumps, roots – **risk of tripping or stumbling!**

Make sure you always have good balance and secure footing.

### **When working at heights:**

- Always use a lift bucket
- Never use the machine while standing on a ladder or in a tree
- Never work on an insecure support
- Never work above shoulder height
- Never use the machine with just one hand

Be particularly alert and cautious when wearing hearing protection because your ability to hear warnings (shouts, alarms, etc.) is restricted.

Take breaks when you start getting tired or feeling fatigue – **risk of accidents!**

Work calmly and carefully – in daylight conditions and only when visibility is good. Proceed with caution, do not put others in danger.



As soon as the engine is running, the power machine generates toxic exhaust gas. These gases may be odorless and invisible and may contain unburned hydrocarbons and benzene. Never run the engine indoors or in poorly ventilated locations, even if your model is equipped with a catalytic converter.

To reduce the risk of serious or fatal injury from breathing toxic fumes, ensure proper ventilation when working in trenches, hollows or other confined locations. **This reduces the risk of serious or fatal injury from breathing toxic fumes.**

Stop work immediately if you start suffering from nausea, headaches, impaired vision (e.g. your field of vision gets smaller), impaired hearing, dizziness, or impaired concentration – these symptoms may possibly be the result of too-high exhaust gas concentration – **Risk of accidents!**

Operate your power tool so that it produces a minimum of noise and emissions – do not run the engine unnecessarily, accelerate the engine only when working.

Dust (e.g. wood dust), fumes and smoke may be produced while working may be hazardous to health! Wear a dust mask in case of dust formation.

No smoking when working with or near the machine – **risk of fire!** Combustible fuel vapor may escape from the fuel system.

If your power tool is subjected to unusually high loads for which it was not designed (e.g. heavy impact or a fall), always check that it is in good condition before continuing work – see also "Before Starting". Check in particular that the fuel system has no leaks and the safety equipment is fully operative. Never use a power tool that is no longer safe to operate. In case of doubt, contact a dealer.

Do not operate your power tool in the starting throttle position – engine speed cannot be controlled in this position.

Only touch the drill and the drill spindle if the engine is stopped and the gear stick is in idle position (position **N**) – **Risk of injury!**



Avoid contact with lines carrying electrical current – **Risk of electrical shock!**

Hold the machine firmly so that sudden jolts can be absorbed – only apply a small amount of pressure when drilling.

Take particular care when working in stony areas or ground with roots.

Cover drilled holes and make safe.

To change the drilling tool, stop the engine and put the gear in idle position (position **N**) – **Risk of injury!**

Do not touch machine parts, particularly the muffler – **Risk of burn injuries.**

Before you leave the machine: Shut the engine off.

Regularly check that the auger is in perfect working condition. Replace damaged or blunt augers immediately.

## Vibrations

Prolonged use of the power tool may result in vibration-induced circulation problems in the hands (whitefinger disease).

No general recommendation can be given for the length of usage because it depends on several factors.

The period of usage is prolonged by:

- Hand protection (wearing warm gloves)
- Work breaks

The period of usage is shortened by:

- Any personal tendency to suffer from poor circulation (symptoms: frequently cold fingers, tingling sensations).
- Low outside temperatures.
- The force with which the handles are held (a tight grip restricts circulation).

Continual and regular users should monitor closely the condition of their hands and fingers. If any of the above symptoms appear (e.g. tingling sensation in fingers), seek medical advice.

## Maintenance and Repairs

Service the machine regularly. Do not attempt any maintenance or repair work not described in the instruction manual. Have all other work performed by a servicing dealer.



STIHL recommends that you have servicing and repair work carried out exclusively by an authorized STIHL servicing dealer. STIHL dealers are regularly given the opportunity to attend training courses and are supplied with the necessary technical information.

Only use high-quality replacement parts in order to avoid the risk of accidents and damage to the machine. If you have any questions in this respect, consult a servicing dealer.

STIHL recommends the use of genuine STIHL replacement parts. They are specifically designed to match your model and meet your performance requirements.

To reduce the risk of injury, **always shut off the engine** before carrying out any maintenance or repairs or cleaning the machine. – Exception: Carburetor and idle speed adjustments.

Do not turn the engine over on the starter with the spark plug boot or spark plug removed unless the slide control / stop switch is on **STOP** or **0** since there is otherwise a **risk of fire** from uncontained sparking.

To reduce the **risk of fire**, do not service or store your machine near open flames.

Check the fuel filler cap for leaks at regular intervals.

Use only a spark plug of the type approved by STIHL and make sure it is in good condition – see "Specifications".

Inspect the ignition lead (insulation in good condition, secure connection).

Check the condition of the muffler.

To reduce the **risk of fire and damage to hearing**, do not operate your machine if the muffler is damaged or missing.

Do not touch a hot muffler since **burn injury** will result.

Vibration behavior is influenced by the condition of the AV elements – check the AV elements at regular intervals.

## Mounting the Handles

### Assist handle for wood drill

#### Before mounting a new wood drill assist handle for the first time

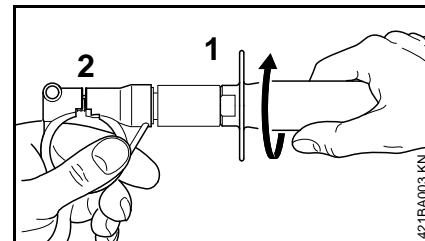

- Hold the handle (1) by the clamp and turn it clockwise until the gap (2) is completely closed.

This breaks the small plastic retainer in the clamp and allows the clamp to be opened up.

#### Normal mounting procedure

- Hold the clamp firmly and unscrew the handle counterclockwise.

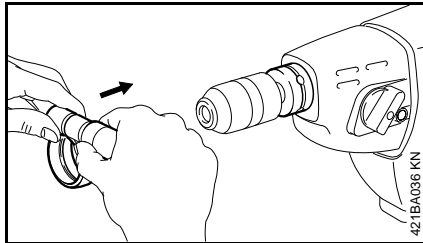

- Open up the clamp slightly.
- Push the handle over the chuck until it butts against the machine – the clamp must engage the groove on the gearbox housing.

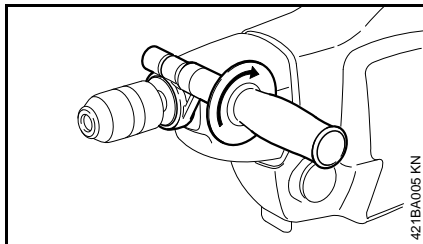

- Screw the handle into clamp clockwise.
- Move the handle to the required position and tighten it down firmly.

### Assist handle for planting hole auger and ice auger

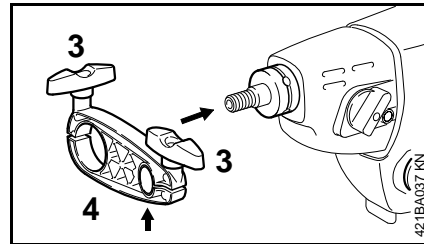

- Loosen the two wing screws (3) on the flange (4).
- Make sure the polymer bushing is properly seated (see arrow).

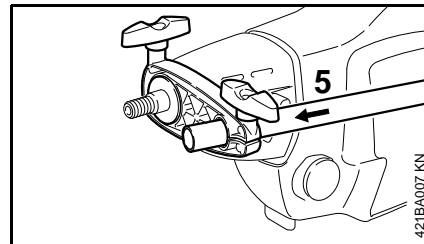

- Push the flange onto the machine as far as stop and line it up.
- Insert the handle tube (5) in the flange.
- Move the handle to the required position and tighten down the two wing screws firmly.

## Using the Unit

Your power drill can be used for a range of applications, e.g. fence-building and carpentry (kit for wood drill), in landscaping and gardening (kit for planting hole auger) and ice fishing (kit for ice auger).

### General

#### WARNING

To change the drilling tool, always shut off the engine and set the rotary knob to **N**.

Always fit the assist handle specified for the drilling tool you intend to use. See "Mounting the Handles".

#### WARNING

During operation, always hold the machine firmly with both hands to control unexpected reactive forces caused by the drilling tool jamming in or passing through the material.

### Working with the ice auger

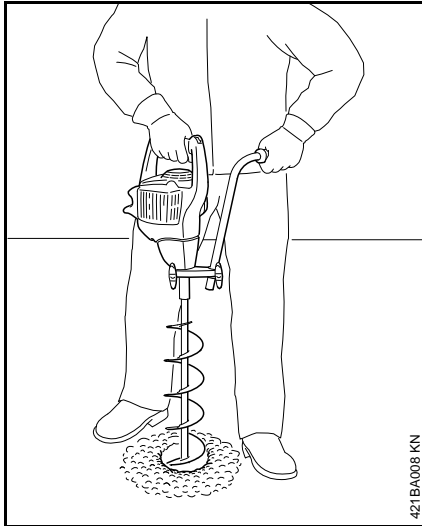

- Before stepping on the ice, check its carrying capacity.
- Make sure you have a safe and secure footing.

#### **! WARNING**

During operation, always hold the machine firmly with both hands to control unexpected reactive forces caused by the drilling tool jamming in or penetrating the ice. Release the throttle trigger if the drilling tool jams.

### Working with the planting hole auger

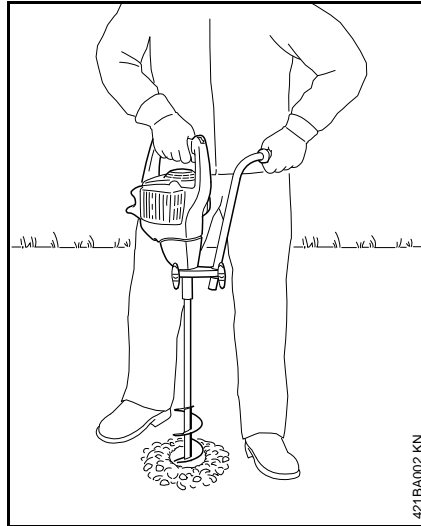

- Make sure you have a safe and secure footing.

#### **! WARNING**

During operation, always hold the machine firmly with both hands to control unexpected reactive forces that may occur if the drilling tool jams, e.g. in rocky ground. Release the throttle trigger if the drilling tool jams.

The planting hole auger should be operated only with the gearbox set to position 1. The tool speed is too high for drilling planting holes when the gearbox is set to position 2.

### Working with a wood drill or twist drill

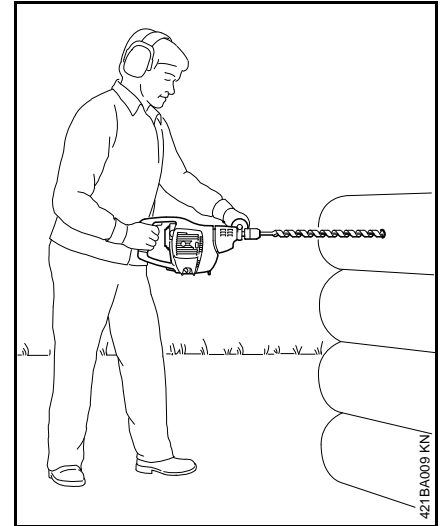

- Make sure you have a safe and secure footing.

#### **! WARNING**

During operation, always hold the machine firmly with both hands to control unexpected reactive forces caused by the drilling tool jamming in or passing through the wood. Release the throttle trigger if the drilling tool jams.

#### **Drilling tool jammed**

See "Releasing a Trapped Auger".

## Fuel

Your engine requires a mixture of gasoline and engine oil.

### WARNING

For health reasons, avoid direct skin contact with gasoline and avoid inhaling gasoline vapor.

### STIHL MotoMix

STIHL recommends the use of STIHL MotoMix. This ready-to-use fuel mix contains no benzol or lead, has a high octane rating and ensures that you always use the right mix ratio.

STIHL MotoMix uses STIHL HP Ultra two-stroke engine oil for an extra long engine life.

MotoMix is not available in all markets.

### Mixing Fuel

### NOTICE

Unsuitable fuels or lubricants or mix ratios other than those specified may result in serious damage to the engine. Poor quality gasoline or engine oil may damage the engine, sealing rings, hoses and the fuel tank.

### Gasoline

Use only high-quality **brand-name** gasoline with a minimum octane rating of 90 – leaded or unleaded.

Gasoline with an ethanol content of more than 10% can cause running problems in engines with a manually adjustable carburetor and should not be used in such engines.

Engines equipped with M-Tronic deliver full power when run on gasoline with an ethanol content of up to 25% (E25).

### Engine Oil

If you mix the fuel yourself, use only STIHL two-stroke engine oil or another high-performance engine oil in accordance with JASO FB, JASO FC, JASO FD, ISO-L-EGB, ISO-L-EGC or ISO-L-EGD.

STIHL specifies STIHL HP Ultra two-stroke engine oil or an equivalent high-performance engine oil in order to maintain emission limits over the machine's service life.

### Mix Ratio

STIHL 50:1 two-stroke engine oil: 50 parts gasoline to 1 part oil

### Examples

Gasoline Liters	STIHL engine oil 50:1 Liters (ml)
1	0.02 (20)
5	0.10 (100)
10	0.20 (200)
15	0.30 (300)
20	0.40 (400)
25	0.50 (500)

- Use a canister approved for storing fuel. Pour oil into canister first, then add gasoline and mix thoroughly.

### Storing Fuel

Store fuel only in approved safety-type fuel canisters in a dry, cool and safe location protected from light and the sun.

**Fuel mix ages** – only mix sufficient fuel for a few weeks work. Do not store fuel mix for longer than 30 days. Exposure to light, the sun, low or high temperatures can quickly make the fuel mix unusable.

STIHL MotoMix may be stored for up to 2 years without any problems.

- Thoroughly shake the mixture in the canister before fueling your machine.

### WARNING

Pressure may build up in the canister – open it carefully.

- Clean the fuel tank and canister from time to time.

Dispose of remaining fuel and cleaning fluid properly in accordance with local regulations and environmental requirements.

## Fueling



### Preparations

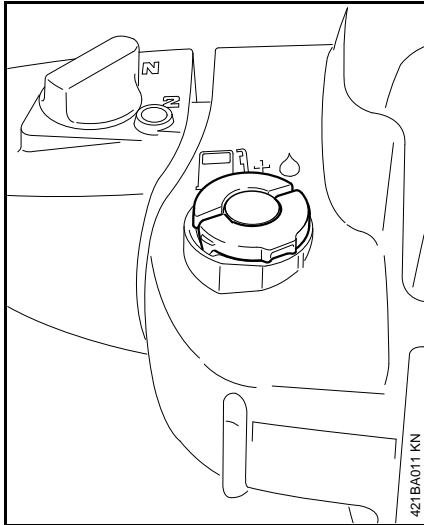

- Before fueling, clean the filler cap and the area around it to ensure that no dirt falls into the tank.
- Position the machine so that the filler cap is facing up.

### Different markings on filler caps

Filler caps and fuel tanks can be marked differently.

Depending on the version, filler cap and fuel tank may be available with or without markings.

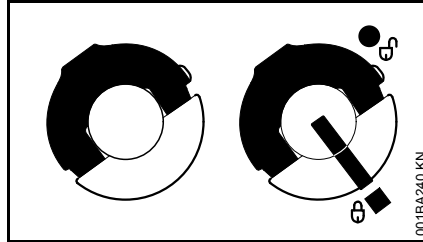

left:	Filler cap - without markings
right:	Filler cap - with markings on cap and fuel tank

### Filler cap without marking

To open:

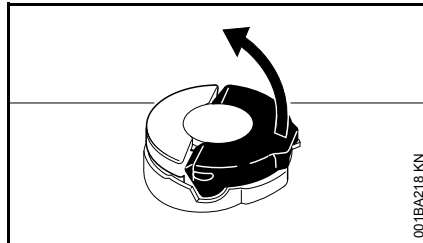

- Open bracket until it is vertical

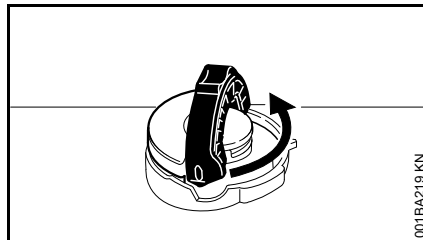

- Turn the filler cap counterclockwise (approx. 1/4 turn)

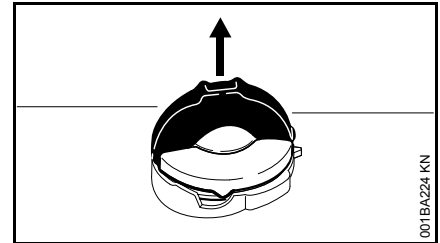

- Remove the filler cap

### Filling with fuel

Take care not to spill fuel while fueling and do not overfill the tank.

STIHL recommends using the STIHL filling system for fuel (special accessory).

- Fill with fuel

### Closing

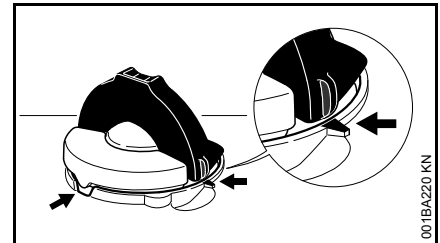

Bracket is in an upright position:

- Position filler cap – position markings on the filler cap and the filler port must be aligned with each other.
- Push the filler cap down as far as it will go

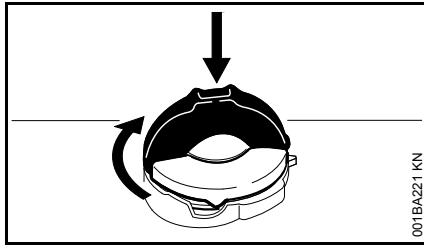

- Hold the filler cap down and turn it clockwise until it engages

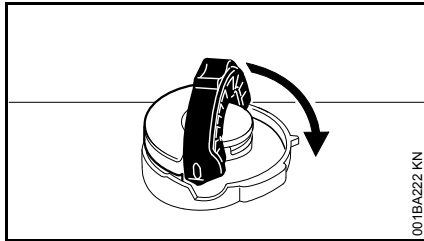

- Fold down the bracket as far as it will go

#### Checking the lock

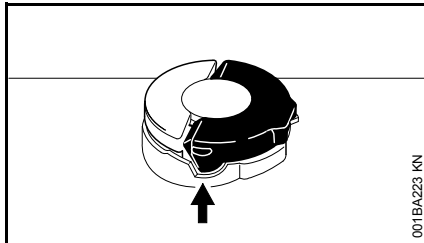

- The lug on the bracket must engage entirely in the recess (arrow)

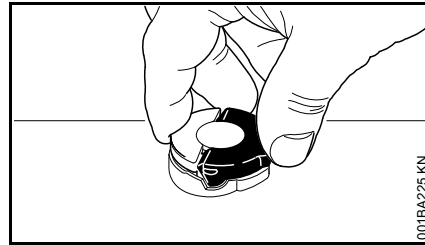

- Grip the filler cap – if the filler cap cannot be moved or removed, then it is closed properly

#### If the filler cap can be moved or removed

The base of the filler cap is twisted in relation to the upper part.

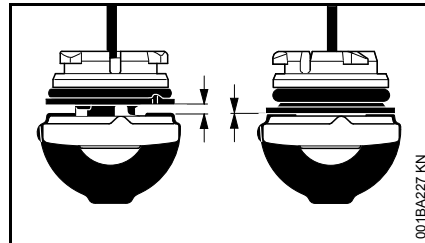

- left: Base of filler cap twisted
- right: Base of filler cap correctly positioned

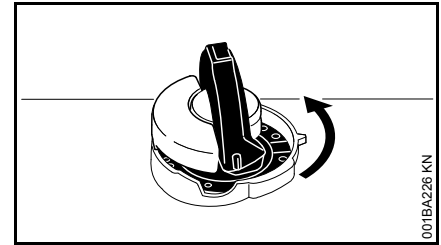

- Fit filler cap and turn it counterclockwise until it engages in the seat of the filling port
- Continue to turn the filler cap counterclockwise (approx. 1/4 turn) – this will twist the base of the cap into the correct position
- Turn the filler cap clockwise and close it – see the section "Closing" and "Checking the lock"

#### Filler cap with marking

#### To open:

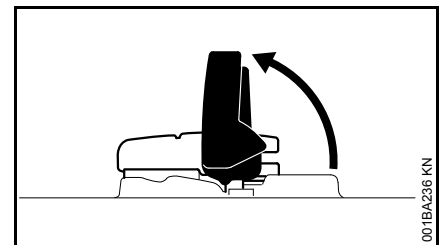

- Open bracket

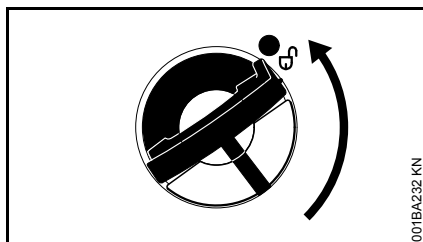

- Turn filler cap (approx. 1/4 turn)

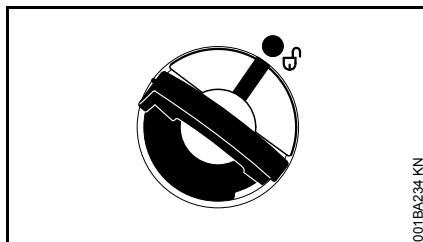

Markings on filler cap and fuel tank must align

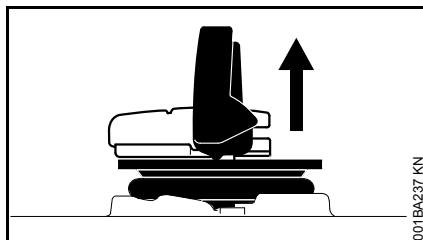

- Remove the filler cap

### Filling with fuel

Take care not to spill fuel while fueling and do not overfill the tank.

STIHL recommends using the STIHL filling system for fuel (special accessory).

- Fill with fuel

### Closing

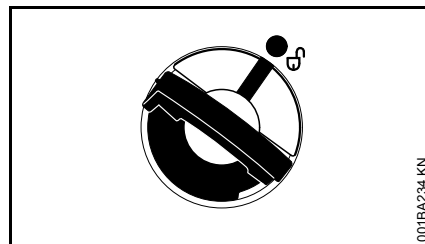

Bracket is in an upright position:

- Position filler cap – markings on filler cap and fuel tank must align
- Push the filler cap down as far as it will go

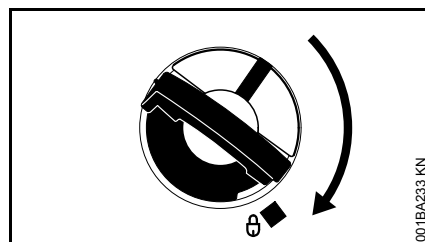

- Hold the filler cap down and turn it clockwise until it engages

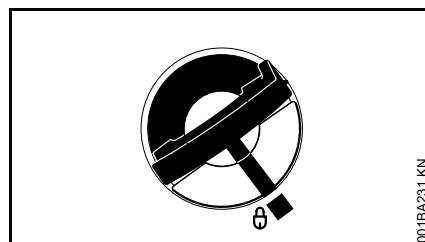

Then the markings on filler cap and fuel tank will align

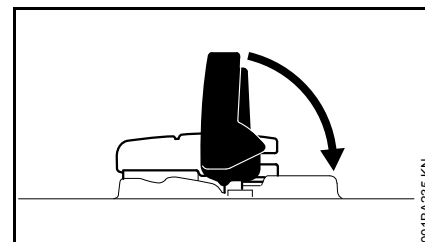

- Close bracket lock

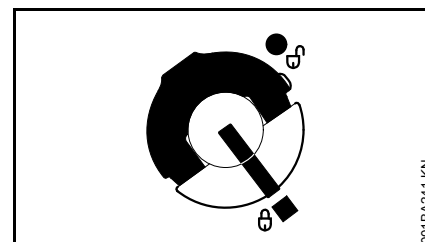

Filler cap is locked

### If the filler cap will not lock onto the fuel tank

The base of the filler cap is twisted in relation to the upper part.

- Remove the filler cap from the fuel tank and look at it from above

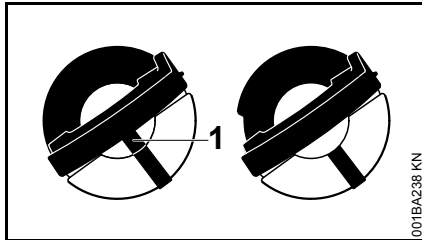

001BA238 KN

left:	Base of filler cap is twisted – interior marking (1) is aligned with the exterior marking
right:	Base of filler cap is in the correct position – interior marking is below the bracket. It does not align with the exterior marking

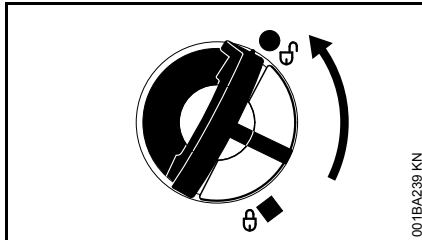

001BA238 KN

- Fit filler cap and turn it counterclockwise until it engages in the seat of the filling port
- Continue to turn the filler cap counterclockwise (approx. 1/4 turn) – this will twist the base of the cap into the correct position
- Turn the filler cap clockwise and close it – see section "Closing"

## Gearbox

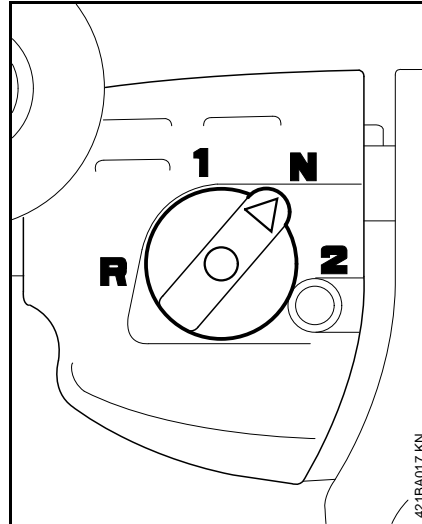

421BA017 KN

The power drill is equipped with a change-speed gearbox. Depending on the application and the drilling tool used, the speed can be adjusted to suit requirements.

### Knob positions



The position of the rotary knob may be changed only when the engine is running at idle speed – the drilling spindle must be stationary. It may be necessary to turn the drilling spindle slightly before the rotary knob can be moved to the required position.

### WARNING

Do not change the position of the rotary knob while the engine is running above idle speed – the drilling tool rotates.

- N** Neutral: Gearbox in neutral for starting, adjusting the carburetor and changing the drilling tool.
- 1** Low-speed clockwise rotation, see "Specifications"
- 2** High-speed clockwise rotation, see "Specifications"
- R** Counterclockwise rotation, e.g. for releasing a trapped drilling tool



## Fitting the Auger

- With the engine stopped (knob in **N** position), out the machine on the ground and make sure it is secure.

### Chuck for wood drills or twist drills

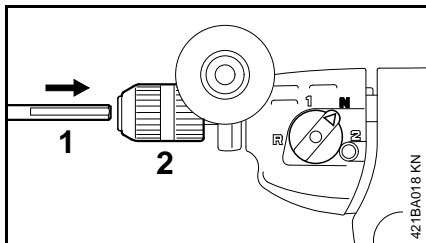

- Insert the drilling tool (1) in the chuck (2) and tighten it firmly.

### **!** WARNING

!When using the geared rim drill chuck (special accessory), make sure you remove the chuck key before starting up.

## Adapter for ice auger or planting hole auger

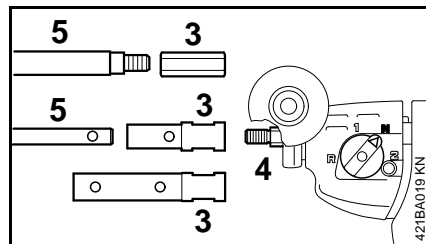

- Screw the adapter (3) onto the drilling spindle (4).
- Use a 13mm open-end wrench to hold the spindle steady and tighten the adapter firmly with a 19mm open-end wrench.
- Secure the drilling tool (5) in the adapter.
- Use a 17mm open-end wrench to secure and release the planting hole auger.

## Starting / Stopping the Engine

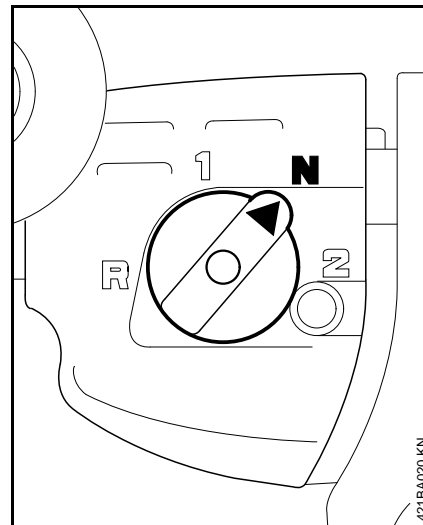

- Set rotary knob to **N** (gearbox in neutral).

### **!** WARNING

The machine may only be started with the gearbox in neutral. If left in positions **1**, **2** and **R**, the drilling tool may begin to rotate when the clutch engagement speed is reached. This could result in accidents or personal injury due to loss of control.

## Starting the Engine

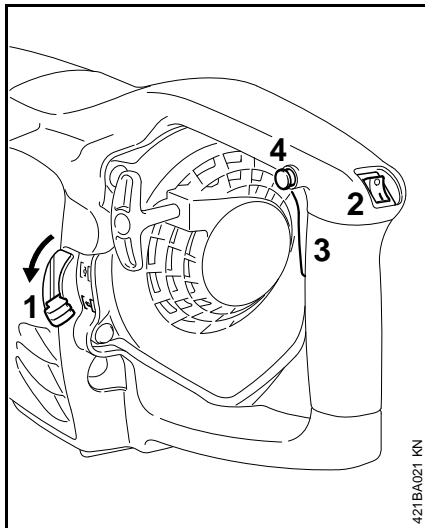

- Depress the choke lever (1) and set it to

I if the engine is cold

|↑| for warm start – also use this position if the engine has been running but is still cold.

- Move the stop switch (2) to I and
- squeeze the throttle trigger (3) and hold it there.
- Press in the starting throttle lock (4) and hold it there.
- Let go of the throttle trigger and starting throttle lock. This is the **starting throttle position**.

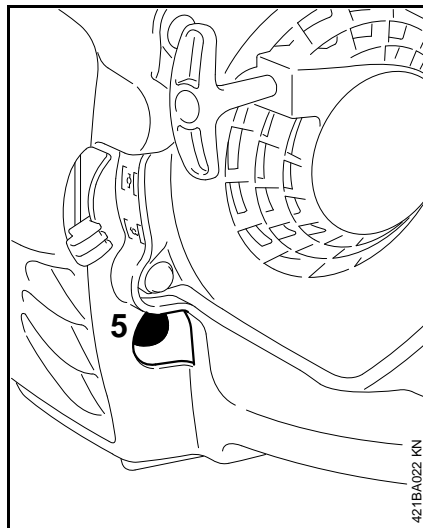

- Press the manual fuel pump bulb (5) at least five times.

## Cranking

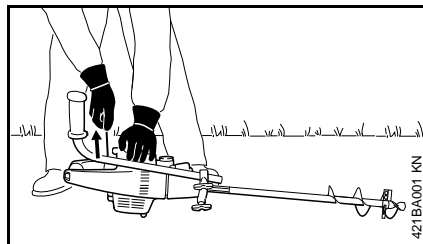

- Place the unit on the ground so that it is secure.
- Press the machine against the ground with your left hand on the engine housing.
- Pull the starter grip slowly with your right hand until you feel it engage and then give it a brisk strong pull. Do not pull out the starter rope to full length – **it might otherwise break**.

Do not let the starter grip snap back. Guide it slowly back into the housing so that the starter rope can rewind properly.

## When engine begins to fire

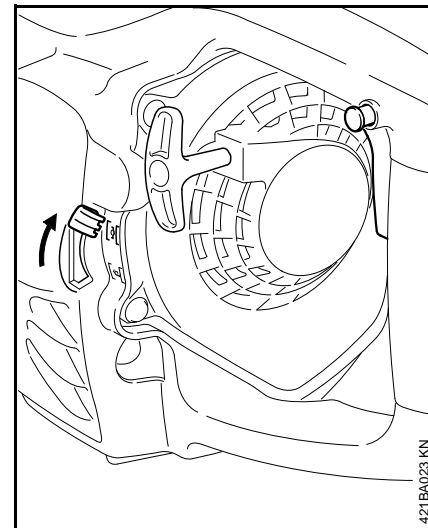

- Set choke lever to |↑| and
- continue cranking.

## As soon as the engine runs

- Blip the throttle trigger – the starting throttle lock moves to the normal run position and the engine returns to idling speed.

## Stopping the Engine

- Move the stop switch to 0.

### At very low outside temperatures

- As soon as the engine runs: Blip the throttle trigger to disengage the starting throttle lock – it moves to the normal run position and the engine returns to idle speed.
- Open throttle slightly – warm up the engine for a short period.

### If engine does not start

If you did not move the choke lever quickly enough to |†| (warm start) after the engine began to fire, the engine is flooded.

- Set choke lever to |†| and
- Set the throttle trigger to the starting throttle position.
- Start the engine by pulling the starter rope briskly – 10 to 20 pulls may be necessary.

### If the engine still does not start

- Remove the spark plug – see "Spark Plug".
- Dry the spark plug.
- Open the throttle wide.
- Crank the engine several times with the starter to clear the combustion chamber.
- Install the spark plug – see "Spark Plug".
- Move the stop switch to I and
- set choke lever to |†| – (warm start position) even if the engine is cold.
- Now start the engine.

### If fuel tank has been run completely dry and then refueled

- Press the fuel pump bulb at least five times.
- Now start the engine.

## Operating Instructions

### During break-in period

A factory-new machine should not be run at high revs (full throttle off load) for the first three tank fillings. This avoids unnecessary high loads during the break-in period. As all moving parts have to bed in during the break-in period, the frictional resistances in the engine are greater during this period. The engine develops its maximum power after about 5 to 15 tank fillings.

### During Operation

After a long period of full throttle operation, allow the engine to run for a short while at idle speed so that engine heat can be dissipated by the flow of cooling air. This protects engine-mounted components (ignition, carburetor) from thermal overload.

### After Finishing Work

Storing for a short period: Wait for the engine to cool down. Empty the fuel tank and keep the machine in a dry place, well away from sources of ignition, until you need it again. For longer out-of-service periods – see "Storing the Machine".

## Releasing a Trapped Auger

If the auger jams in the drill hole

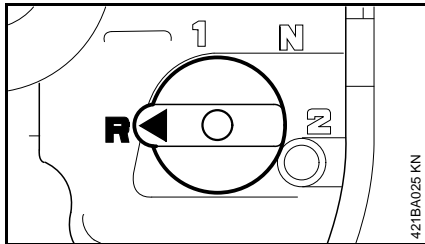

- Let go of the throttle trigger so that the engine returns to idling speed.
- Move rotary knob to **R** position (counterclockwise rotation) – it may be necessary to rotate the machine a little until the knob can be moved to the required position.
- Hold the machine firmly with both hands on the handles.
- Operate the throttle trigger.
- Increase engine speed and slowly pull the drilling tool out of the drill hole.

## Cleaning the Air Filter

If there is a noticeable loss of engine power

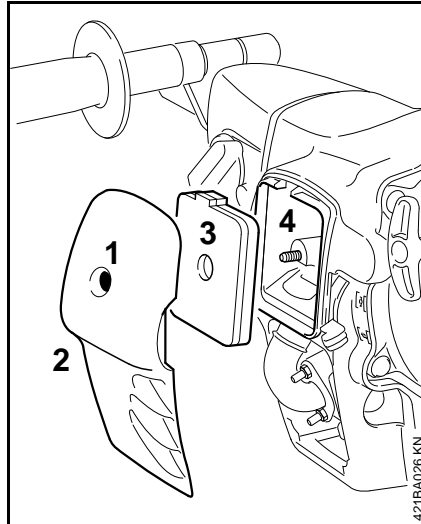

- Set the choke lever to .
- Loosen the screw (1).
- Remove the air filter cover (2).
- Clean away loose dirt from around the filter.
- Take the air filter (3) out of the filter housing (4).
- Replace with a new filter – or, as a temporary measure, knock it out or blow it clear – do not wash.
- Replace any damaged parts.
- Install the filter in the filter housing.

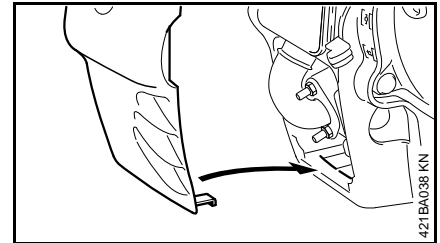

- Fit the filter cover, engage the two tabs (arrows) at the bottom first.
- Insert the screw and tighten it down firmly.

## Adjusting the Carburetor

### General Information

The carburetor comes from the factory with a standard setting.

This setting provides an optimum fuel-air mixture under most operating conditions.

### Preparations

- Shut off the engine.
- Remove the auger.
- Check the air filter and clean or replace if necessary.

### Standard Setting

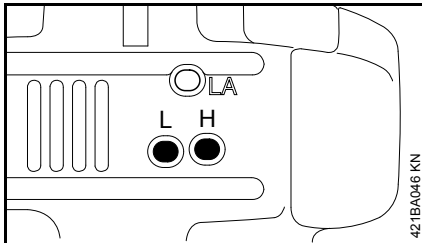

- Turn high speed screw (H) counterclockwise as far as stop (no more than 3/4 turn).
- Turn the low speed screw (L) carefully clockwise until it is against its seat, then turn it back 1 full turn

### Adjusting Idle Speed

- Carry out the standard setting.
- Set rotary knob to **N** (gearbox in neutral).
- Start and warm up the engine.
- Move the rotary knob to **1**.

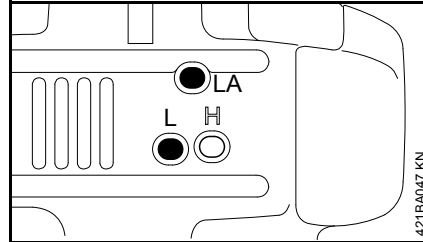

- Adjust idle speed with the idle speed screw (LA) so that the drilling spindle does not rotate.

### Engine stops while idling

- Turn the idle speed screw (LA) slowly clockwise until the engine runs smoothly – the drilling spindle must not rotate.

### Drilling spindle rotates when engine is idling

- Turn the idle speed screw (LA) counterclockwise until the drilling spindle stops rotating and then turn the screw another 1/2 to 1 turn in the same direction.

### WARNING

If the drilling spindle continues rotating when the engine is idling, have your power drill checked and repaired by your servicing dealer.

**Erratic idling behavior, poor acceleration (even though standard setting of low speed screw is correct)**

Idle setting is too lean

- Turn the low speed screw (L) slowly counterclockwise until the engine runs and accelerates smoothly.

It is usually necessary to change the setting of the idle speed screw (LA) after every correction to the low speed screw (L).

### Fine Tuning for Operation at High Altitude

A slight correction of the setting may be necessary if the engine does not run satisfactorily:

- Carry out the standard setting.
- Set rotary knob to **N** (gearbox in neutral).
- Warm up the engine.
- Turn high speed screw (H) slightly clockwise (leaner) – no further than stop.

### NOTICE

After returning from high altitude, reset the carburetor to the standard setting.

If the setting is too lean there is a risk of engine damage due to insufficient lubrication and overheating.

## Spark Plug

- If the engine is down on power, difficult to start or runs poorly at idle speed, first check the spark plug.
- Fit a new spark plug after about 100 operating hours – or sooner if the electrodes are badly eroded. Install only suppressed spark plugs of the type approved by STIHL – see "Specifications".

### Removing the Spark Plug

- Move the stop switch to 0.

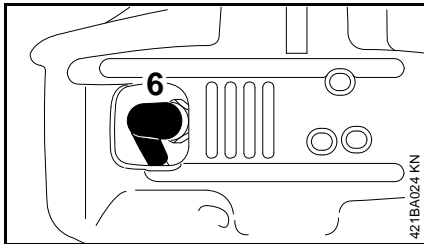

- Remove the spark plug boot (6).
- Unscrew the spark plug.

### Checking the Spark Plug

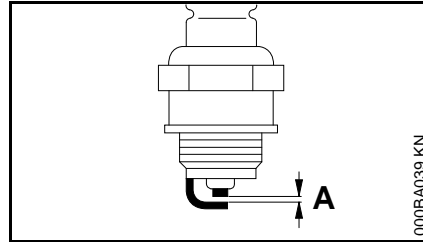

- Clean dirty spark plug.
- Check electrode gap (A) and readjust if necessary – see "Specifications".
- Rectify the problems which have caused fouling of the spark plug.

Possible causes are:

- Too much oil in fuel mix.
- Dirty air filter.
- Unfavorable running conditions.

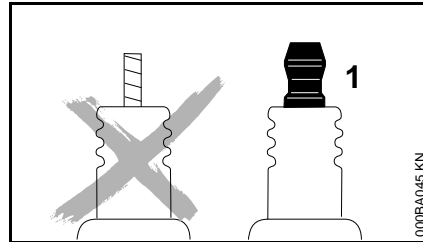

### WARNING

Arcing may occur if the adapter nut (1) is loose or missing. Working in an easily combustible or explosive atmosphere may cause a fire or an explosion. This can result in serious injuries or damage to property.

- Use resistor type spark plugs with a properly tightened adapter nut.

### Installing the spark plug

- Fit the spark plug by hand and screw it in
- Tighten spark plug with combination wrench
- Press the spark plug boot firmly onto the spark plug

## Engine Running Behavior

If engine running behavior is unsatisfactory even though the air filter is clean and the carburetor is properly adjusted, the cause may be the muffler.

Have the muffler checked for contamination (carbonization) by your servicing dealer.

STIHL recommends that you have servicing and repair work carried out exclusively by an authorized STIHL servicing dealer.

## Storing the Machine

For periods of 3 months or longer

- Remove the drilling tool.
- Drain and clean the fuel tank in a well ventilated area.
- Dispose of fuel properly in accordance with local environmental requirements.
- Run the engine until the carburetor is dry – this helps prevent the carburetor diaphragms sticking together.
- Thoroughly clean the machine – pay special attention to the cylinder fins and air filter.
- Store the machine in a dry, high or locked location, out of the reach of children and other unauthorized persons.

## Maintenance and Care

The following intervals apply for normal operating conditions. The specified intervals must be shortened accordingly when working for longer than normal or under difficult cutting conditions (extensive dust, etc.).		Before starting work	At the end of work and/or daily	Whenever tank is refilled	Weekly	Monthly	Annually	If faulty	If damaged	As required
Complete machine	Visual inspection (condition, leaks)	X		X						
	Clean		X							
Control handle	Function test	X		X						
Air filter	Clean							X		
	replace								X	
Manual fuel pump (if present)	check	X								
	Have repaired by a specialist dealer <sup>2)</sup>								X	
Fuel pickup body in fuel tank	check							X		
	replace						X			X
Fuel tank	Clean						X			
Carburetor	Check idle adjustment – drilling spindle must not rotate	X								
	Readjust idle speed									X
cover	Adjust electrode gap							X		
	Replace after 100 operating hours									
All accessible screws, nuts and bolts (not adjusting screws)	Tighten									X
Anti-vibration elements	check	X						X		X
	Have replaced by dealer <sup>2)</sup>								X	
Boring spindle	Clean		X							
Drilling tool	check	X								
	replace								X	X
Safety information label	replace								X	

<sup>2)</sup> STIHL recommends STIHL dealers



## Minimize Wear and Avoid Damage

Observing the instructions in this manual helps reduce the risk of unnecessary wear and damage to the power tool.

The power tool must be operated, maintained and stored with the due care and attention described in this owner's manual.

The user is responsible for all damage caused by non-observance of the safety precautions, operating and maintenance instructions in this manual. This includes in particular:

- Alterations or modifications to the product not approved by STIHL.
- Using tools or accessories which are neither approved or suitable for the product or are of a poor quality.
- Using the product for purposes for which it was not designed.
- Using the product for sports or competitive events.
- Consequential damage caused by continuing to use the product with defective components.

### Maintenance Work

All the operations described in the "Maintenance Chart" must be performed on a regular basis. If these maintenance operations cannot be performed by the owner, they should be performed by a servicing dealer.

STIHL recommends that you have servicing and repair work carried out exclusively by an authorized STIHL

servicing dealer. STIHL dealers are regularly given the opportunity to attend training courses and are supplied with the necessary technical information.

If these maintenance operations are not carried out as specified, the user assumes responsibility for any damage that may occur. Among other parts, this includes:

- Damage to the engine due to neglect or deficient maintenance (e.g. air and fuel filters), incorrect carburetor adjustment or inadequate cleaning of cooling air inlets (intake ports, cylinder fins).
- Corrosion and other consequential damage resulting from improper storage.
- Damage to the machine resulting from the use of poor quality replacement parts.

### Parts Subject to Wear and Tear

Some parts of the power tool are subject to normal wear and tear even during regular operation in accordance with instructions and, depending on the type and duration of use, have to be replaced in good time. Among other parts, this includes:

- Auger brake
- Clutch
- Augers
- Filters (air, fuel)
- Rewind starter

- Spark plug
- Damping elements of anti-vibration system

## Main Parts

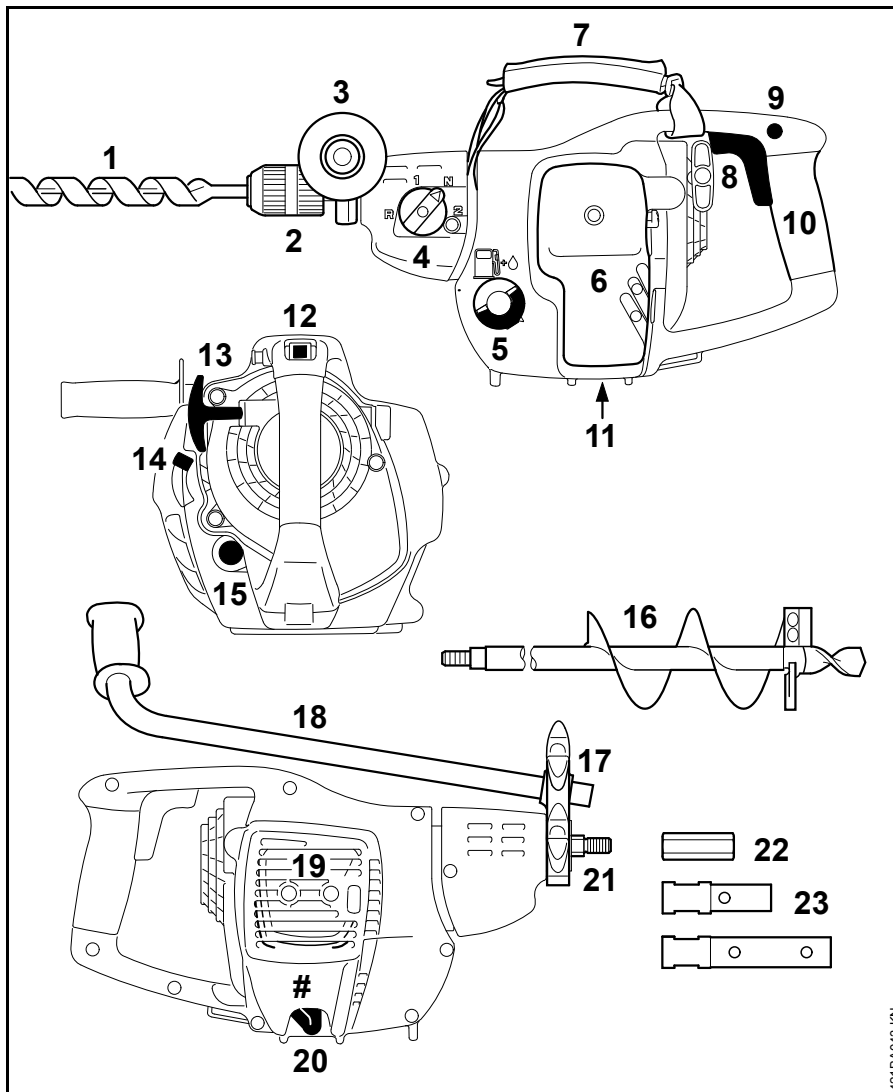

- 1 Wood Drill<sup>2)</sup> / Twist Drill<sup>2)</sup>
- 2 Chuck<sup>1)</sup>
- 3 Assist Handle<sup>1)</sup>
- 4 Knob
- 5 Tank Cap
- 6 Air Filter Cover
- 7 Carrying Strap<sup>2)</sup>
- 8 Throttle Trigger
- 9 Starting Throttle Lock
- 10 Control Handle
- 11 Carburetor Adjusting Screws
- 12 Stop Switch
- 13 Starter Grip
- 14 Choke Lever
- 15 Manual Fuel Pump
- 16 Planting Hole Auger<sup>2)</sup> / Ice Auger<sup>2)</sup>
- 17 Flange<sup>1)</sup>
- 18 Assist Handle<sup>1)</sup>
- 19 Muffler
- 20 Spark Plug Boot
- 21 Drilling Spindle
- 22 Adapter for Planting Hole Auger
- 23 Adapter for Ice Auger
- # Serial number

1) Depending on model

2) Special accessory

## Specifications

### Engine

STIHL single cylinder two-stroke engine

Displacement:	27.2 cc
Bore:	34 mm
Stroke:	30 mm
Engine power to ISO 7293:	0.8 kW (1.1 bhp) at 7,000 rpm
Idle speed:	2,800 rpm
Cut-off speed:	9,500 rpm

### Ignition System

Electronic magneto ignition

Spark plug (resistor type):	Bosch WSR 6 F, NGK BPMR 7 A
Electrode gap:	0.5 mm

### Fuel System

All position diaphragm carburetor with integral fuel pump

Fuel tank capacity:	250 cc (0.25 l)
---------------------	-----------------

### Gearbox

Three-stage spur gear drive

Gearbox setting	Max. spindle speed
1	910 rpm
2	2,710 rpm
R	810 rpm

### Weight

Dry, without auger  
4.8 kg

### Dimensions

without attachment and chuck

Length:	235 mm
Width:	235 mm
Height:	440 mm

### Noise and Vibration Data

Noise and vibration data are measured at idling and maximum rated speed in a ratio of 1:4.

For further details on compliance with Vibration Directive 2002/44/EC see [www.stihl.com/vib/](http://www.stihl.com/vib/)

#### Sound pressure level $L_{peq}$ to EN ISO 11201

98 dB(A)

#### Sound power level $L_{weq}$ to ISO 3744

103 dB(A)

#### Vibration measurement $a_{hv,eq}$ to ISO 8662

##### 13 mm wood drill, gearbox setting 1

Left handle:	7.2 m/s <sup>2</sup>
Right handle:	6.1 m/s <sup>2</sup>

##### 13 mm wood drill, gearbox setting 2

Left handle:	7.2 m/s <sup>2</sup>
Right handle:	7.5 m/s <sup>2</sup>

#### 90 mm planting hole auger, gearbox setting 1

Left handle:	12.0 m/s <sup>2</sup>
Right handle:	7.0 m/s <sup>2</sup>

The K-factor in accordance with Directive 2006/42/EC is 2.0 dB(A) for the sound pressure level and sound power level; the K-factor in accordance with Directive 2006/42/EC is 2.0 m/s<sup>2</sup> for the vibration level.

### REACH

REACH is an EC regulation and stands for the Registration, Evaluation, Authorisation and Restriction of Chemical substances.

For information on compliance with the REACH regulation (EC) No. 1907/2006 see [www.stihl.com/reach](http://www.stihl.com/reach).

### Exhaust Emissions

The CO<sub>2</sub> value measured in the EU type approval procedure is specified at [www.stihl.com/co2](http://www.stihl.com/co2).

The measured CO<sub>2</sub> value was determined on a representative engine in accordance with a standardized test procedure under laboratory conditions and does not represent either an explicit or implied guarantee of the performance of a specific engine.

The applicable exhaust emission requirements are fulfilled by the intended usage and maintenance described in this instruction manual. The type approval expires if the engine is modified in any way.

## Maintenance and Repairs

Users of this machine may only carry out the maintenance and service work described in this user manual. All other repairs must be carried out by a servicing dealer.

STIHL recommends that you have servicing and repair work carried out exclusively by an authorized STIHL servicing dealer. STIHL dealers are regularly given the opportunity to attend training courses and are supplied with the necessary technical information.

When repairing the machine, only use replacement parts which have been approved by STIHL for this power tool or are technically identical. Only use high-quality replacement parts in order to avoid the risk of accidents and damage to the machine.

STIHL recommends the use of original STIHL replacement parts.

Original STIHL parts can be identified by the STIHL part number, the **STIHL** logo and the STIHL parts symbol  (the symbol may appear alone on small parts).

## Disposal

Observe all country-specific waste disposal rules and regulations.

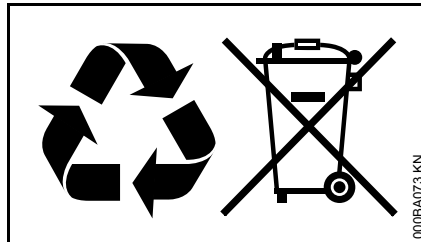

STIHL products must not be thrown in the garbage can. Take the product, accessories and packaging to an approved disposal site for environment-friendly recycling.

Contact your STIHL servicing dealer for the latest information on waste disposal.

## EC Declaration of Conformity

ANDREAS STIHL AG & Co. KG  
Badstr. 115  
D-71336 Waiblingen

Germany

declares under our sole responsibility that

Designation:	Power drill
Make:	STIHL
Series:	BT 45
Serial identification number:	4314
Displacement:	27.2 <sup>3</sup>

conforms to the relevant provisions of Directives 2011/65/EU, 2006/42/EC and 2014/30/EU and has been developed and manufactured in compliance with the following standards in the versions valid on the date of production:

EN ISO 12100+A1, EN 55012,  
EN 61000-6-1

Technical documents deposited at:

ANDREAS STIHL AG & Co. KG  
Produktzulassung (Product Licensing)

The year of manufacture and serial number are applied to the product.

Done at Waiblingen, 03.02.2020

ANDREAS STIHL AG & Co. KG

pp

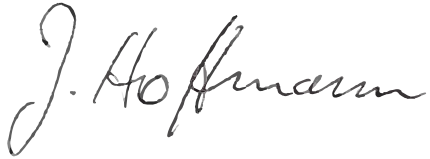
A handwritten signature in black ink, reading "J. Hoffmann". The signature is written in a cursive style with a large, looped initial "J".

Dr. Jürgen Hoffmann

Head of Product Data, Regulations and  
Licensing

The CE mark, consisting of the letters "C" and "E" in a bold, sans-serif font, positioned side-by-side.





0458-421-0121-A

englisch



[www.stihl.com](http://www.stihl.com)



0458-421-0121-A