

STIHL[®]

STIHL SP-KM

Instruction Manual



Contents

KombiSystem	2
Guide to Using this Manual	2
Safety Precautions and Working Techniques	2
Using the Unit	6
Approved KombiEngines	7
Assembling the Unit	7
Mounting the KombiTool	9
Fitting the Harness	9
Starting / Stopping the Engine	10
Storing the Machine	11
Inspection and Maintenance by User	11
Maintenance and Care	13
Minimize Wear and Avoid Damage	13
Main Parts	14
Specifications	15
Maintenance and Repairs	16
Disposal	16
EC Declaration of Conformity	16

Dear Customer,

Thank you for choosing a quality engineered STIHL product.

It has been built using modern production techniques and comprehensive quality assurance. Every effort has been made to ensure your satisfaction and trouble-free use of the product.

Please contact your dealer or our sales company if you have any queries concerning this product.

Your



Dr. Nikolas Stihl

STIHL®

SP-KM

KombiSystem

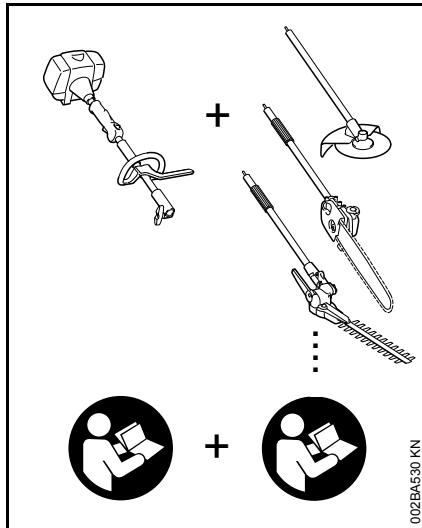

In the STIHL KombiSystem a number of different KombiEngines and KombiTools can be combined to produce a power tool. In this instruction manual the functional unit formed by the KombiEngine **and** KombiTool is referred to as the power tool.

Therefore, the separate instruction manuals for the KombiEngine and KombiTool should be used together for the power tool.

Always read and and make sure you understand **both** instruction manuals before using your power tool for the first time and keep them in a safe place for future reference.

Guide to Using this Manual

Pictograms

All the pictograms attached to the machine are shown and explained in this manual.

Symbols in text



WARNING

Warning where there is a risk of an accident or personal injury or serious damage to property.



NOTICE

Caution where there is a risk of damaging the machine or its individual components.

Engineering improvements

STIHL's philosophy is to continually improve all of its products. For this reason we may modify the design, engineering and appearance of our products periodically.

Therefore, some changes, modifications and improvements may not be covered in this manual.

Safety Precautions and Working Techniques



Special safety precautions must be observed when working with this power tool because the rakes and tines move at a high stroke rate.



Always read and and make sure you understand both instruction manuals (KombiEngine and KombiTool) before using your power tool for the first time and keep them in a safe place for future reference. Non-observance of the instruction manual may result in serious or even fatal injury.

Lend or rent your power tool only to persons who are familiar with this model and its operation – do not lend or rent your power tool without the KombiEngine and KombiTool instruction manuals.

Use your special harvester only for harvesting fruit about the size of coffee berries, nuts, olives, sloes, etc.

Do not use your power tool for any other purpose because of the **increased risk of accidents**.

Only mount rakes and tines or accessories that are explicitly approved for this power tool by STIHL or are technically identical. If you have any questions in this respect, consult a servicing dealer.

Use only high quality tools and accessories in order to avoid the risk of accidents and damage to the machine.

STIHL recommends the use of original STIHL replacement parts and accessories. They are specifically designed to match the product and meet your performance requirements.

Never attempt to modify your machine in any way since this may increase the risk of personal injury. STIHL excludes all liability for personal injury and damage to property caused while using unauthorized attachments.

Do not use a pressure washer to clean your power tool. The solid jet of water may damage parts of the power tool.

Clothing and Equipment

Wear proper protective clothing and equipment.



Clothing must be sturdy but allow complete freedom of movement. Wear snug-fitting clothing, an overall and jacket combination, do not wear a work coat.

Avoid clothing that could get caught on branches or brush or moving parts of the machine. Do not wear a scarf, necktie or jewelry. Tie up and confine long hair (e.g. with a hair net, cap, hard hat, etc.).



Wear sturdy shoes with non-slip soles.

WARNING



To reduce the risk of eye injuries, wear close-fitting safety glasses in accordance with European Standard EN 166. Make sure the safety glasses are a comfortable and snug fit.

Wear a face shield and make sure it is a good fit. A face shield alone does not provide adequate eye protection.

Wear hearing protection, e.g. earplugs or ear muffs.

Wear a safety hard hat with chin strap where there is a danger of head injuries from falling objects.



Wear heavy-duty work gloves made of durable material (e.g. leather).

STIHL offers a comprehensive range of personal protective clothing and equipment.

Transporting the Power Tool

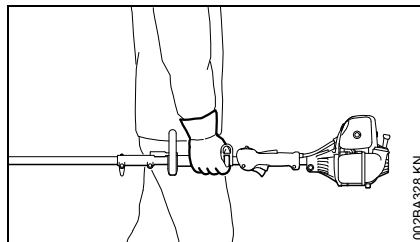

Always shut off the engine.

Carry the machine hanging from the shoulder strap or properly balanced by the drive tube – tines pointing to the rear.

Do not touch hot parts of the machine since **burn injury** will result.

Transporting by vehicle: Properly secure your power tool to prevent turnover, fuel spillage and damage.

Before Starting

Check that your power tool is properly assembled and in good condition – refer to appropriate chapters in the KombiEngine and KombiTool instruction manuals.

- Tines on rakes: correctly and securely mounted and in good condition (clean, not warped or cracked).
- Never attempt to modify the controls or the safety devices in any way.
- Keep the handles dry and clean – free from oil and dirt – for safe control of the power tool.
- Adjust the harness to suit your height and reach. See chapter on "Fitting the Harness".

To reduce the risk of accidents, operate your power tool only if it is in a safe condition.

If you use a shoulder strap or full harness: Practice removing and putting down the machine as you would in an emergency. To avoid damage, do not throw the machine to the ground when practicing.

Holding and Controlling the Power Tool

Make sure you always have good balance and secure footing.

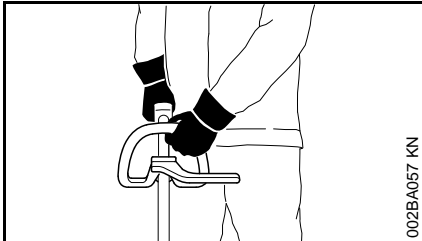

Always hold the power tool firmly with both hands on the handles.

Right hand on control handle, left hand on loop handle, even if you are left-handed. Wrap fingers and thumbs firmly around the handles.

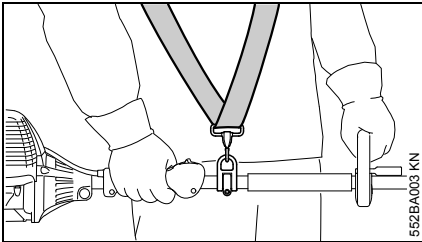

The machine can be carried on a shoulder strap to relieve the weight on the operator's arms.

During Operation

In the event of impending danger or in an emergency, switch off the engine immediately by moving the slide control / stop switch/button to **STOP** or **0**.



This power tool is not insulated against electric shock. To reduce the **risk of electrocution** maintain a minimum clearance of 15 m from electric power lines.

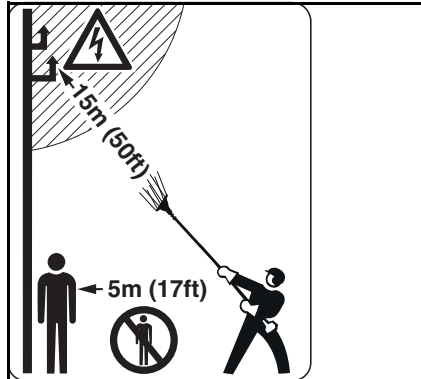

To reduce the risk of injury from falling objects, do not allow bystanders within a radius of 15 meters of your own position.

To reduce the risk of damage to property, also maintain this distance from other objects (vehicles, windows).

Maintain a minimum clearance of 15 m between the tips of the rakes and electric power lines. Electricity can jump considerable distances by means of arcing. Higher voltage increases the distance electricity can arc. Have the power switched off before starting work in the immediate vicinity of power lines.

The correct engine idle speed is important to ensure that the attachment stops moving when you let go of the throttle trigger. Check and correct the idle speed setting regularly. If the attachment still moves when the engine is idling, have your dealer check your

machine and make proper adjustments or repairs – see KombiEngine instruction manual.

Note that the rakes and tines continue to run for a short period after you let go of the throttle trigger (flywheel effect).



The gearhead becomes hot during operation. **To reduce the risk of burn injury**, do not touch the gear housing.

Take special care in slippery conditions on slopes and uneven ground.

Watch out for obstacles: Roots and tree stumps which **could cause you to trip or stumble**.

Clear away fallen branches and scrub from the work area.

Keep the rakes and tines clear of foreign objects – such objects may be caught and thrown and damage the rakes and tines.

Make sure you always have good balance and secure footing.

When working at heights:

- Always use a lift bucket
- Never work on a ladder or in a tree
- Never work on an insecure support
- Never operate your power tool with one hand

Be particularly alert and cautious when wearing hearing protection because your ability to hear warnings (shouts, alarms, etc.) is restricted.

To reduce the risk of accidents, take a break in good time to avoid tiredness or exhaustion.

Work calmly and carefully – in daylight conditions and only when visibility is good. Stay alert so as not to endanger others.

Never touch the rakes or tines while the engine is running. If the rakes or tines become jammed by thick branches or other obstructions, switch off the engine immediately before attempting to remove the obstruction.

Opening the throttle while the rakes and tines are blocked increases the load and reduces engine speed. The clutch then slips continuously and this causes overheating and damage to important components (e.g. clutch, polymer housing components) – and **this can increase the risk of injury** from the rakes and tines moving while the engine is idling.

If your power tool is subjected to unusually high loads for which it was not designed (e.g. heavy impact or a fall), always check that it is in good condition before continuing work – see also "Before Starting". Make sure the safety devices are working properly. Do not continue operating your power tool if it is damaged. In case of doubt, consult your servicing dealer.

Check the rakes and tines at regular short intervals or immediately if there is a noticeable change in the tool's behavior:

- Shut off the engine, hold the machine securely.
- Wait until the rakes and tines come to a complete standstill.

- Check condition and tightness, look for cracks.
- Replace damaged parts immediately, even if they have only superficial cracks.

To reduce the risk of injury, shut off the engine before changing the tines.

Never continue using or attempt to repair damaged or cracked rakes or tines.

After Finishing Work

After finishing work or before leaving the power tool unattended: Shut off the engine.

After finishing work, clean dirt, soil and plant residue off the attachment – **wear gloves to reduce the risk of injury**.

Do not use grease solvents for cleaning.

After thoroughly cleaning, coat metal surface of attachments with a corrosion inhibitor.

Maintenance and Repairs

Service the machine regularly. Do not attempt any maintenance or repair work not described in the KombiTool and KombiEngine instruction manuals. Have all other work performed by a servicing dealer.

STIHL recommends that you have servicing and repair work carried out exclusively by an authorized STIHL servicing dealer. STIHL dealers are regularly given the opportunity to attend training courses and are supplied with the necessary technical information.

Only use high-quality replacement parts in order to avoid the risk of accidents and damage to the machine. If you have any questions in this respect, consult a servicing dealer.

STIHL recommends the use of genuine STIHL replacement parts. They are specifically designed to match your model and meet your performance requirements.

To reduce the risk of injury, **always shut off the engine** before carrying out any maintenance or repairs or cleaning the machine.

Using the Unit

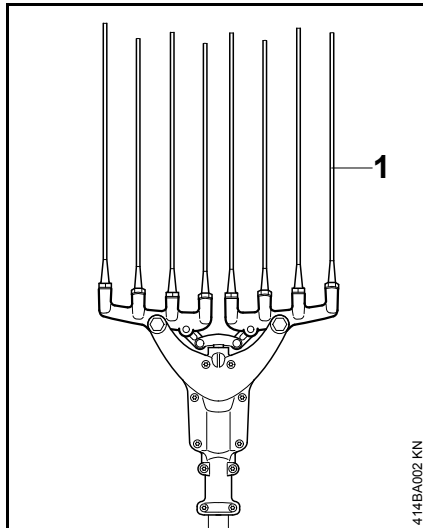

This power tool is used for harvesting nuts and fruits.

The influences of ripeness, variety and size of fruits or nuts determines whether this power tool is suitable for harvesting. The performance of this special harvester is affected by the above-mentioned factors.

This unit is not recommended for harvesting dessert fruit, e.g. apples, pears, plums, etc.

WARNING

Do not operate the unit if one of the tines (1) is missing or broken. Operating the unit with broken and/or missing tines (1) may result in the operator being exposed to high loads caused by increased vibration – see "Vibrations".

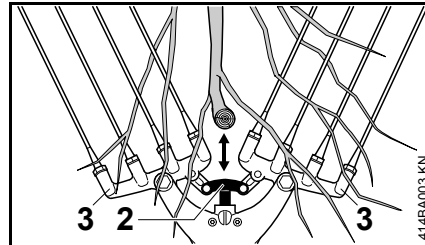

NOTICE

The forkhead (2) performs rapid reciprocating movements during operation. Take care not to damage branches with the forkhead. Do not force branches between the rakes (3).

Working Technique

Use the following working technique to obtain best results and good performance from the harvester:

- Accelerate the engine and comb the branches with the rakes. Use the throttle trigger to obtain the optimum rake stroke rate.
- Keep the throttle open only as long as the rakes are engaged in the branches.
- Do not accelerate the engine when the rakes are not engaged in the branches.
- Reposition the rakes in the next section of the tree.
- Repeat this process for all sections of the tree.

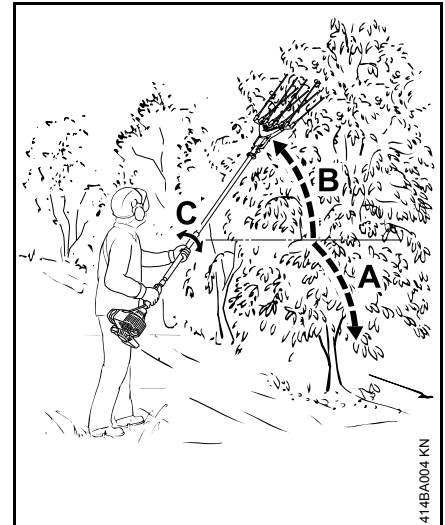

- Pay attention to the tree's limb structure during operation:
- Comb the lower section (A) from the top downwards, this also applies for drooping branches at the outer extremities of the tree.
- Comb the upper section (B) from the bottom upwards.
- Comb the tree from the inside outwards, towards the tips of the branches.
- While combing the branches, turn the rakes to and fro around the shaft's axis (C) if necessary.
- Have the **whole** tree even if there is very little fruit left on it.
- Do not hold the unit in one spot for too long so as not to damage leaves and branches unnecessarily.
- Always shut off the engine before leaving the unit unattended.

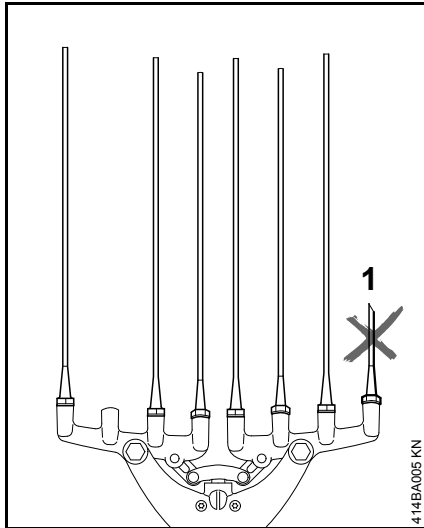

NOTICE

Operating the unit with broken and/or missing tines (1) may result in damage to gearbox components or overload them. Therefore, do not continue using a unit with broken and/or missing tines.

Operating the unit with broken and/or missing tines reduces the unit's harvesting performance.

- Always replace damaged tines – see chapter on "Inspection and Maintenance by User".

Approved KombiEngines

Only use KombiEngines supplied by STIHL or expressly approved by STIHL for use with the attachment.

This KombiTool may be operated only in combination with the following KombiEngines/Motors:

STIHL KM 55 R, KM 56 R, KM 85 R¹⁾,
KM 90 R, KM 94 R, KM 100 R,
KM 110 R¹⁾, KMA 130 R

WARNING

Loop-handled power tools must be equipped with a barrier bar.

Assembling the Unit

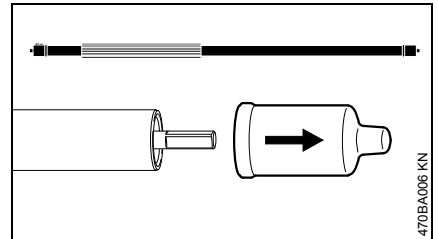

- Use the drive tube supplied with the unit.
- Pull the protective caps off the ends of the drive tube and keep them in a safe place for later use – see "Storing the Machine".

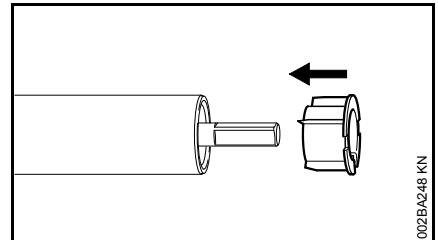

The plug may come out of the drive tube when you pull off the cap. Push it back into the drive tube as far as stop.

¹⁾ outside the EU only

Mounting the gearhead

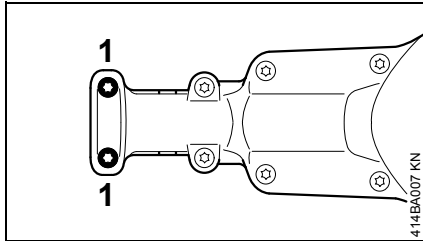

- Loosen the clamp screws (1) on the gearhead – do not remove them.

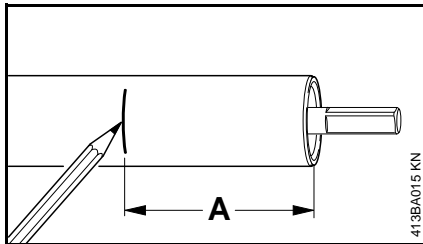

- Apply a mark (with pencil or crayon) at distance A (50 mm) from the end of the drive tube.

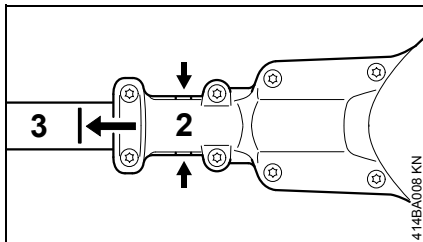

- Push the gearhead (2) onto the drive tube (3) – turn it back and forth at the same time – until it reaches or covers the mark on the drive tube.

Alternative check: The drive tube is correctly positioned when it completely closes the slot in the gearhead's clamp (short arrows).

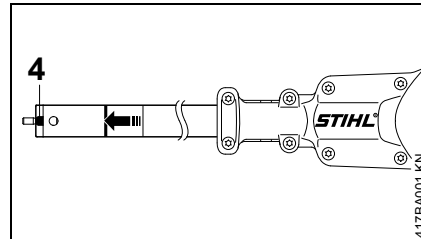

- Line up the center of the gearhead with the lug (4) on the drive tube – the STIHL logo facing up.
- Tighten down the clamp screws on the gearhead firmly.

Installing the tines

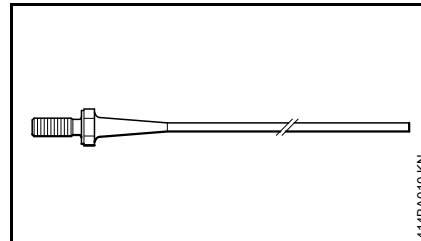

The machine comes standard with 10 tines. Eight tines are fitted and the other two are spares for maintenance, see "Inspection and Maintenance by User".

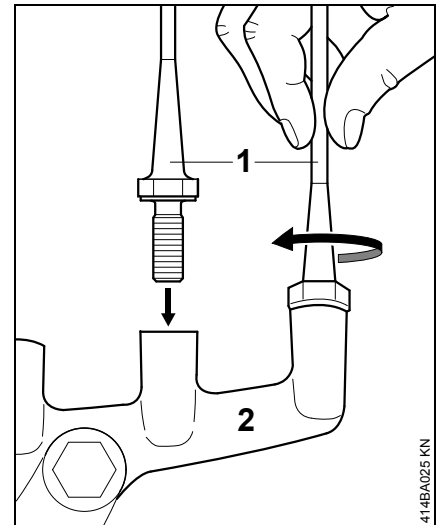

- Screw the tines (1) into the two rakes (2) as far as stop – fit all eight tines on the rakes.
- Tighten down the tines by hand.

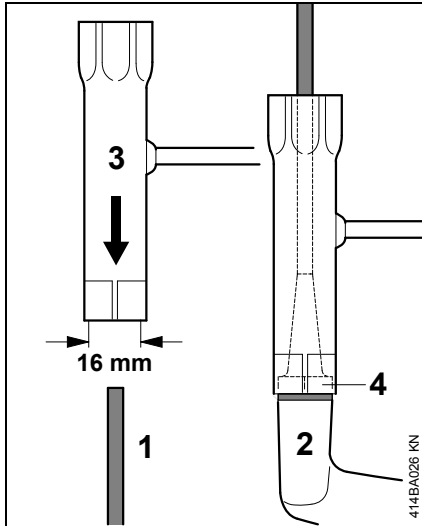

- Engage the combination wrench (3) on the hexagon (4) at the base of tine (1).

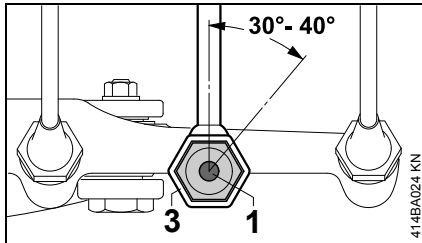

- Use the combination wrench (3) to tighten down the tine (1) firmly by turning it another 30° to 40°.
- Remove the combination wrench from the tine.

Mounting the KombiTool

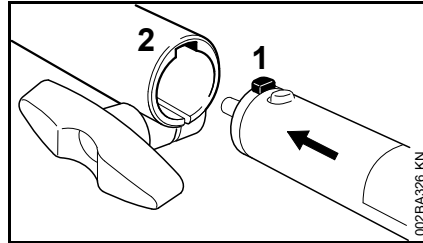

- Push the lug (1) on the drive tube into the slot (2) in the coupling sleeve as far as stop.

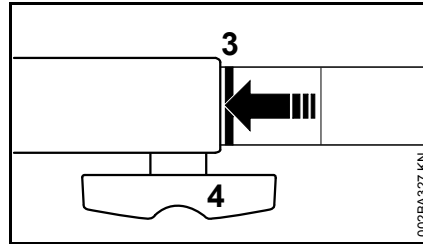

When correctly installed, the red line (3) (arrow point) must be flush with the end of the coupling sleeve.

- Tighten down the star knob (4) **firmly**.

Removing the KombiTool

- Reverse the above sequence to remove the drive tube.

Fitting the Harness

The type and style of the harness, carrying ring and carabiner (spring hook) depend on the market.

Shoulder Strap

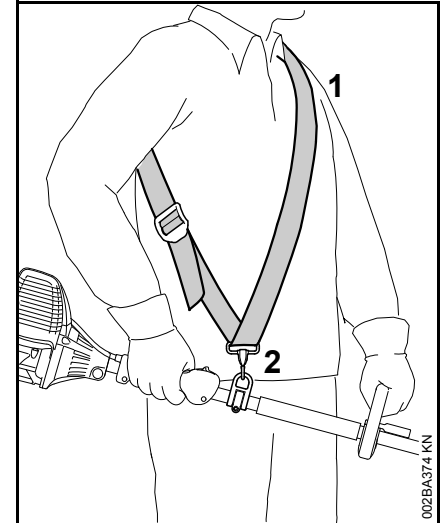

- Put on the shoulder strap (1).
- Adjust the length of the strap so that the carabiner (2) is about a hand's width below your right hip.

Full harness

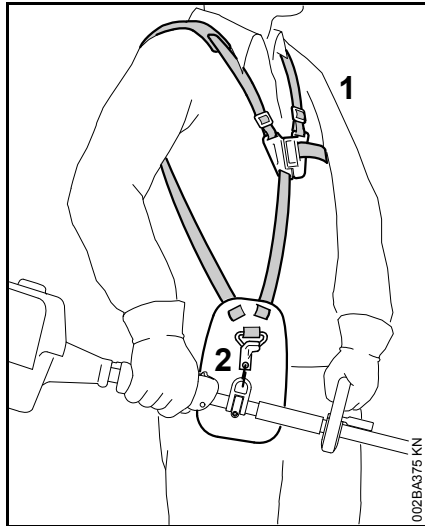

- Put on the full harness (1).
- Adjust the length of the strap so that the carabiner (2) is about a hand's width below your right hip.

Attaching Machine to Harness

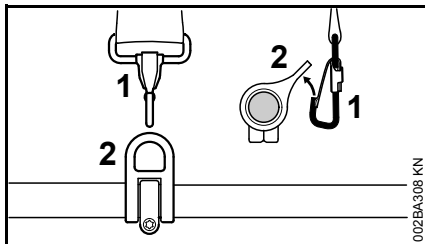

- Attach the carabiner (1) to the carrying ring (2) on the drive tube – hold the carrying ring steady.

Disconnecting Machine from Harness

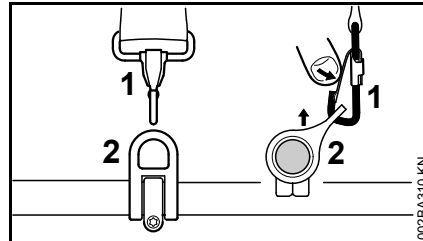

- Press down the bar on the carabiner (1) and pull the carrying ring (2) out of the carabiner.

Throwing Off the Machine



The machine must be quickly thrown off in the event of imminent danger. Practice removing and putting down the machine as you would in an emergency. To avoid damage, do not throw the machine to the ground when practicing.

Practice quickly detaching the power tool from the carabiner as described under "Disconnecting Machine from Harness".

If you are using a shoulder strap: Practice slipping the strap off your shoulder.

If you are using a full harness: Practice quickly opening the locking plate and slipping the harness straps off your shoulders.

Starting / Stopping the Engine

Starting the Engine

Always follow the operating instructions for the KombiEngine and basic power tool.

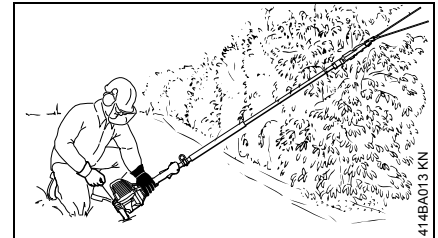

- Place the unit on the ground: It must rest securely on the engine support. Rest the gearhead on a raised support (high mound) or position the drive tube in the fork of a branch.

To reduce the risk of accidents, check that the rakes are not touching the ground or any other obstacles.

- Make sure you have a firm footing, either standing, stooping or kneeling.
- Hold the machine with you left hand and press it down **firmly** – do not touch the controls on the control handle – see KombiEngine or basic power tool instruction manual.



Do not stand or kneel on the drive tube.

Alternative method of starting

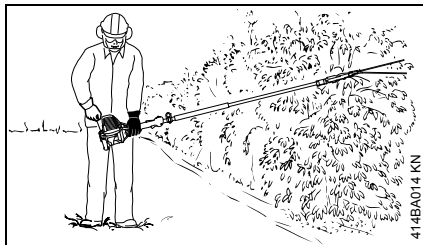

- Make sure you have a safe and secure footing.
- Hold the powerhead firmly with your left hand on the fan housing – your thumb should be under the fan housing.

! WARNING

The rakes may begin to run as soon as the engine starts. For this reason, blip the throttle after starting – the engine returns to idling speed.

The starting procedure is now as described in the instruction manual of the KombiEngine or basic power tool you are using.

Stopping the Engine

- See KombiEngine or basic power tool instruction manual.

Storing the Machine

For periods of 3 months or longer

- Clean the rakes and tines and check them for damage
- If the KombiTool is removed from the KombiEngine and stored separately: Fit the protective cap on the drive tube to avoid dirt getting into the coupling.
- Store the machine in a dry, high or locked location, out of the reach of children and other unauthorized persons.

Inspection and Maintenance by User

Replacing tines

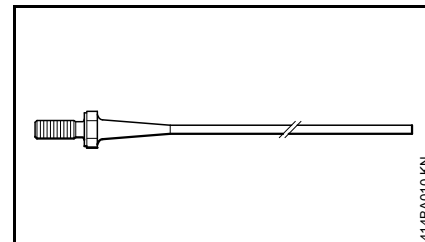

The unit comes standard with 10 tines of which two are intended for machine maintenance. A set of 4 tines is available as a special accessory – for part number see "Special Accessories".

- Broken, badly worn and missing tines must be replaced immediately with new tines.

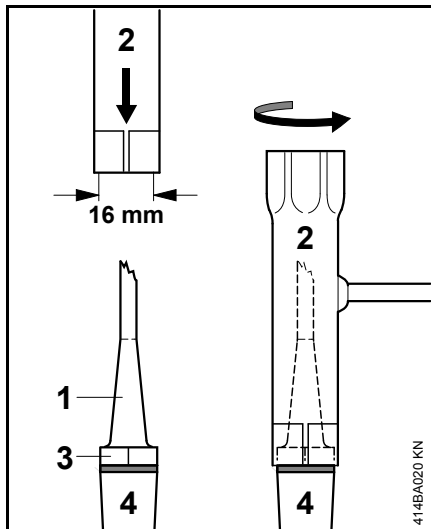

- Engage the combination wrench (2) on the hexagon (3) at the base of the tine (1).
- Use the combination wrench to loosen the tine.
- Unscrew the tine from the rake (4).

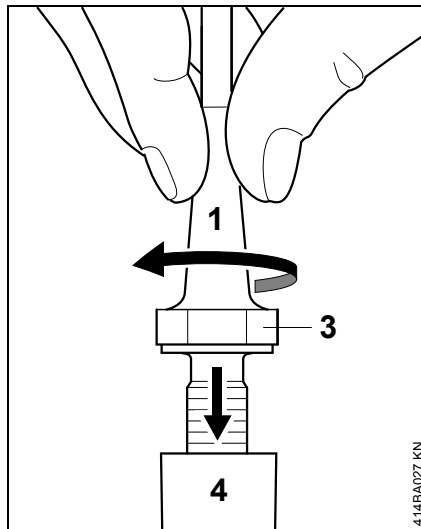

- Screw the tine (1) into the rake (4) as far as possible by hand.
- Engage the combination wrench (2) on the hexagon (3) at the base of tine (1) and screw down as far as stop.

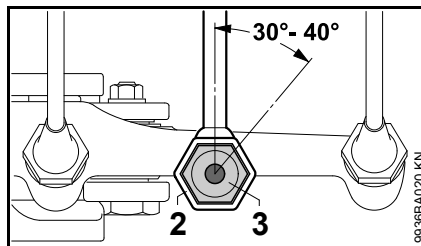

- Use the combination wrench (2) to tighten down the tine (3) firmly by turning it another 30° to 40°.

Fitting Protective Tube on Tine

If the optional set of protective tubes is to be used, for part number see "Special Accessories", fit them before mounting the tines.

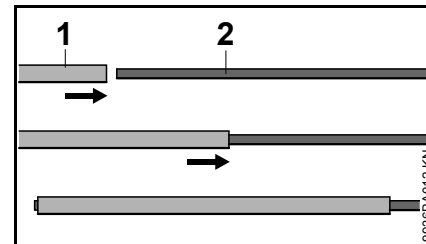

- Position the tube (1) on the end of the tine and push it part-way onto the tine (2).
- Stand the screw end of the tine (1) on a suitable base and gradually pull the tube (2) over the tine.
- Fit the tube (2) so that the ends of the tube and tine (1) are approximately in line.

If you have difficulty fitting the protective tubes, contact your local dealer for assistance. STIHL recommends a STIHL servicing dealer.

Maintenance and Care

The following intervals apply to normal operating conditions only. If your daily working time is longer or operating conditions are difficult (very dusty work area, etc.), shorten the specified intervals accordingly.

All accessible screws and nuts

- Retighten if necessary

Working tools

- Visual inspection of rakes and tines before starting work and after every fueling stop
- Check tightness of tines before starting work and after every fueling stop
- Replace damaged tines immediately

Safety labels

- Replace illegible safety labels

Minimize Wear and Avoid Damage

Observing the instructions in this manual and the KombiEngine manual helps reduce the risk of unnecessary wear and damage to the power tool.

The power tool must be operated, maintained and stored with the due care and attention described in these instruction manuals.

The user is responsible for all damage caused by non-observance of the safety precautions, operating and maintenance instructions. This includes in particular:

- Alterations or modifications to the product not approved by STIHL.
- Using tools or accessories which are neither approved or suitable for the product or are of a poor quality.
- Using the product for purposes for which it was not designed.
- Using the product for sports or competitive events.
- Consequential damage caused by continuing to use the product with defective components.

Maintenance Work

All the operations described in the "Maintenance Chart" and "Inspection and Maintenance by User" must be performed on a regular basis. If these maintenance operations cannot be performed by the owner, they should be performed by a servicing dealer.

STIHL recommends that you have servicing and repair work carried out exclusively by an authorized STIHL servicing dealer. STIHL dealers are regularly given the opportunity to attend training courses and are supplied with the necessary technical information.

If these maintenance operations are not carried out as specified, the user assumes responsibility for any damage that may occur. Among other things, this includes:

- Corrosion and other consequential damage resulting from improper storage.
- Damage to the product resulting from the use of poor quality replacement parts.

Parts Subject to Wear and Tear

Some parts of the power tool, e.g. the rakes and the drive and mounting components of the rakes and tines (connectors, pins, etc.), are subject to normal wear and tear even during regular operation in accordance with instructions and, depending on the type and duration of use, have to be replaced in good time.

Main Parts

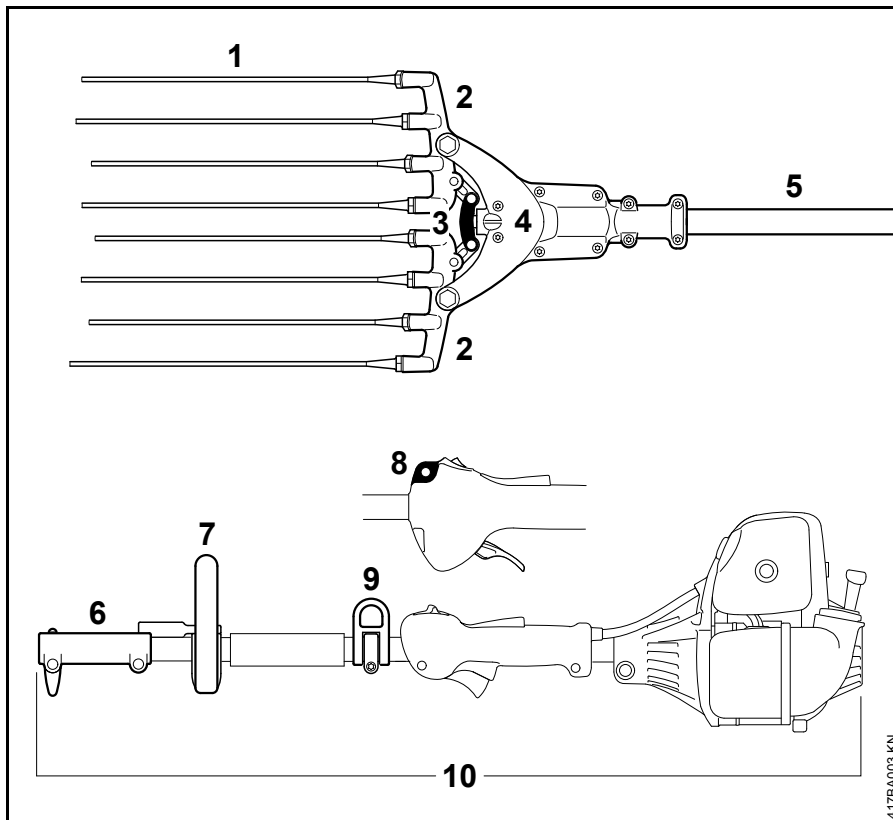

- 1 Tine
- 2 Rake
- 3 Forkhead
- 4 Gearbox
- 5 Drive tube
- 6 Coupling sleeve
- 7 Loop handle
- 8 Integral carrying ring
- 9 Adjustable carrying ring
- 10 KombiEngine

417BA003 KN

Specifications

Gearhead

Gear ratio:	11:1
Forkhead stroke:	20 mm
Strokes per minute at 10,000 rpm ¹⁾ :	1,820/min

- 1) The movement of the rake in one direction is a stroke. The up and down movement of the rake counts as two strokes (= 2 working strokes).

Weight

KombiTool, complete:	2.0 kg
----------------------	--------

Length

KombiTool, complete:	1450 mm
----------------------	---------

Noise and Vibration Data

Noise and vibration data measurements on power tools with the SP-KM KombiTool include idling and rated maximum speed in a ratio of 1:6.

For further details on compliance with Vibration Directive 2002/44/EC visit www.stihl.com/vib.

Sound pressure level L_p to ISO 11201

KM 55 R with loop handle:	93 dB(A)
KM 56 R with loop handle:	94 dB(A)
KM 85 R with loop handle:	93 dB(A)

KM 90 R with loop handle:	90 dB(A)
KM 94 R with loop handle:	91 dB(A)
KMA 130 R with loop handle:	80 dB(A)
KM 100 R with loop handle:	90 dB(A)

Sound power level L_w to ISO 3744

KM 55 R with loop handle:	105 dB(A)
KM 56 R with loop handle:	106 dB(A)
KM 85 R with loop handle:	105 dB(A)
KM 90 R with loop handle:	102 dB(A)
KM 94 R with loop handle:	106 dB(A)
KM 130 R with loop handle:	90 dB(A)
KM 100 R with loop handle:	103 dB(A)

Vibration level $a_{hv,eq}$ to ISO 20643

	Handle, left	Handle, right
KM 55 R with loop handle:	7.0 m/s ²	8.7 m/s ²
KM 56 R with loop handle:	8.5 m/s ²	7.7 m/s ²
KM 85 R with loop handle:	4.3 m/s ²	6.3 m/s ²
KM 90 R with loop handle:	4.9 m/s ²	5.4 m/s ²
KM 94 R with loop handle:	6.8 m/s ²	5.3 m/s ²
KMA 130 R with loop handle:	4.1 m/s ²	3.2 m/s ²
KM 100 R with loop handle:	4.5 m/s ²	5.8 m/s ²

The K-factor in accordance with Directive 2006/42/EC is 2.0 dB(A) for the sound pressure level and sound

power level; the K-factor in accordance with Directive 2006/42/EC is 2.0 m/s² for the vibration level.

REACH

REACH is an EC regulation and stands for the Registration, Evaluation, Authorisation and Restriction of Chemical substances.

For information on compliance with the REACH regulation (EC) No. 1907/2006 see www.stihl.com/reach.

Maintenance and Repairs

Users of this machine may only carry out the maintenance and service work described in this user manual. All other repairs must be carried out by a servicing dealer.

STIHL recommends that you have servicing and repair work carried out exclusively by an authorized STIHL servicing dealer. STIHL dealers are regularly given the opportunity to attend training courses and are supplied with the necessary technical information.

When repairing the machine, only use replacement parts which have been approved by STIHL for this power tool or are technically identical. Only use high-quality replacement parts in order to avoid the risk of accidents and damage to the machine.

STIHL recommends the use of original STIHL replacement parts.

Original STIHL parts can be identified by the STIHL part number, the **STIHL** logo and the STIHL parts symbol  (the symbol may appear alone on small parts).

Disposal

Observe all country-specific waste disposal rules and regulations.

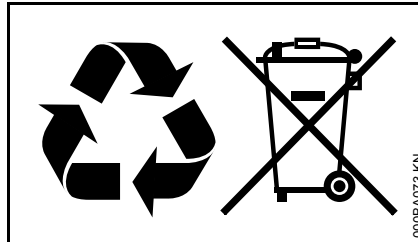

STIHL products must not be thrown in the garbage can. Take the product, accessories and packaging to an approved disposal site for environment-friendly recycling.

Contact your STIHL servicing dealer for the latest information on waste disposal.

EC Declaration of Conformity

ANDREAS STIHL AG & Co. KG
Badstr. 115
D-71336 Waiblingen

Germany

declare in exclusive responsibility that

Category: Special harvester
KombiTool

Make: STIHL

Model: SP-KM

Serial identification: 4249

conforms to the relevant provisions of Directive 2006/42/EC and has been developed and manufactured in compliance with the following standards in the versions valid on the date of production:

EN ISO 12100 (in conjunction with the specified KM and KMA models).

Technical documents deposited at:

ANDREAS STIHL AG & Co. KG
Produktzulassung (Product Licensing)

The year of manufacture is applied to the power tool.

Done at Waiblingen, 08.03.2018

ANDREAS STIHL AG & Co. KG

Thomas Elsner

Director Product Management and
Services

CE

0458-417-0121-A

englisch



www.stihl.com



0458-417-0121-A