

STIHL[®]

STIHL HT 100, 101, 130, 131

Instruction Manual



Contents

Guide to Using this Manual	2	Minimize Wear and Avoid Damage	35
Safety Precautions and Working Techniques	2	Main Parts	36
Using the Unit	8	Specifications	37
Cutting Attachment	10	Maintenance and Repairs	38
Mounting the Bar and Chain	11	Disposal	39
Tensioning the Chain	12	EC Declaration of Conformity	39
Checking Chain Tension	12		
Adjusting the Throttle Cable	13		
Fuel	13		
Fueling	14		
Chain Lubricant	16		
Filling Chain Oil Tank	16		
Checking Chain Lubrication	18		
Adjusting the Telescoping Shaft	18		
Fitting the Harness	19		
Backpack Carrying System	19		
Starting / Stopping the Engine	21		
Operating Instructions	23		
Taking Care of the Guide Bar	24		
Cleaning the Air Filter	25		
Adjusting the Carburetor	25		
Spark Arresting Screen in Muffler	26		
Spark Plug	26		
Storing the Machine	27		
Checking and Replacing the Chain Sprocket	28		
Maintaining and Sharpening the Saw Chain	28		
Inspections and Maintenance by Dealer	32		
Maintenance and Care	33		

Dear Customer,

Thank you for choosing a quality engineered STIHL product.

It has been built using modern production techniques and comprehensive quality assurance. Every effort has been made to ensure your satisfaction and troublefree use of the product.

Please contact your dealer or our sales company if you have any queries concerning this product.

Your



Dr. Nikolas Stihl

STIHL®

HT 100, HT 101, HT 130, HT 131

This instruction manual is protected by copyright. All rights reserved, especially the rights to reproduce, translate and process with electronic systems.

Guide to Using this Manual

Pictograms

The meanings of the pictograms attached to the machine are explained in this manual.

Depending on the model concerned, the following pictograms may be attached to your machine.



Fuel tank; fuel mixture of gasoline and engine oil



Chain oil tank; chain oil



Direction of chain rotation

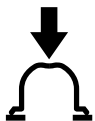

Operate manual fuel pump



Manual fuel pump

Symbols in text



WARNING

Warning where there is a risk of an accident or personal injury or serious damage to property.



Caution where there is a risk of damaging the machine or its individual components.

Engineering improvements

STIHL's philosophy is to continually improve all of its products. For this reason we may modify the design, engineering and appearance of our products periodically.

Therefore, some changes, modifications and improvements may not be covered in this manual.

Safety Precautions and Working Techniques



Special safety precautions must be observed when working with the pole pruner because it is a high-speed, fast-cutting power tool with very sharp cutters and a long reach.



It is important that you read the instruction manual before first use and keep it in a safe place for future reference. Non-observance of the instruction manual may result in serious or even fatal injury.

Observe all applicable local safety regulations, standards and ordinances.

If you have not used this type of power tool before: Have your dealer or other experienced user show you how to operate your machine or attend a special course in its operation.

Minors should never be allowed to use a power tool.

Keep bystanders, especially children, and animals away from the work area.

When the power tool is not in use, shut it off so that it does not endanger others. Secure it against unauthorized use.

The user is responsible for avoiding injury to third parties or damage to their property.

Do not lend or rent your power tool without the instruction manual. Be sure that anyone using it understands the information contained in this manual.

The use of noise emitting power tools may be restricted to certain times by national or local regulations.

To operate the power tool you must be rested, in good physical condition and mental health.

If you have any condition that might be aggravated by strenuous work, check with your doctor before operating a power tool.

Persons with pacemakers only: The ignition system of your power tool produces an electromagnetic field of a very low intensity. This field may interfere with some pacemakers. STIHL recommends that persons with pacemakers consult their physician and the pacemaker manufacturer to reduce any health risk.

Do not operate the power tool if you are under the influence of any substance (drugs, alcohol) which might impair vision, dexterity or judgment.

Use your pole pruner for limbing only (removing or pruning branches). Only cut wood or wooden objects.

Do not use your power tool for any other purpose because of the **increased risk of accidents**.

Only use guide bars, chains, chain sprockets and accessories that are explicitly approved for this power tool model by STIHL or are technically identical. If you have any questions in this respect, consult a servicing dealer.

Use only high quality tools and accessories in order to avoid the risk of accidents and damage to the machine.

STIHL recommends the use of genuine STIHL tools, guide bars, chains, chain sprockets and accessories. They are specifically designed to match the product and meet your performance requirements.

Never attempt to modify your machine in any way since this may increase the risk of personal injury. STIHL excludes all liability for personal injury and damage to property caused while using unauthorized attachments.

Do not use a pressure washer to clean the unit. The solid jet of water may damage parts of the unit.

Clothing and Equipment

Wear proper protective clothing and equipment.



Clothing must be sturdy but allow complete freedom of movement. Wear snug-fitting clothing, an overall and jacket combination, do not wear a work coat.

Avoid clothing that could get caught on branches or brush or moving parts of the machine. Do not wear a scarf, necktie or jewelry. Tie up and confine long hair (e.g. with a hair net, cap, hard hat, etc.).



Wear steel-toed safety boots with non-slip soles and cut-retardant inserts.

! WARNING



To reduce the risk of eye injuries, wear snug-fitting safety glasses in accordance with European Standard EN 166. Make sure the safety glasses are a good fit.

Wear hearing protection, e.g. earplugs or ear muffs.

Wear a safety hard hat with chin strap where there is a danger of head injuries from falling objects.



Wear heavy-duty work gloves made of durable material (e.g. leather).

STIHL offers a comprehensive range of personal protective clothing and equipment.

Transporting the Power Tool

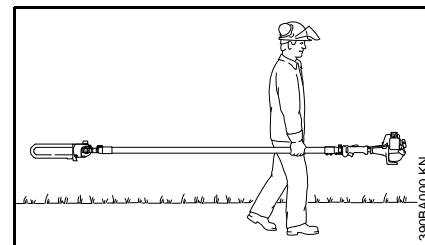

Always turn off the engine.

Always fit the chain guard (scabbard) – even when you carry the unit for short distances.

Carry the power tool properly balanced by the drive tube. **To reduce the risk of serious burn injuries**, avoid touching hot parts of the machine, especially the surface of the muffler.

Transporting by vehicle: Properly secure your power tool to prevent turnover, fuel spillage and damage.

Fueling



Gasoline is an extremely flammable fuel. Keep clear of naked flames. Do not spill any fuel – do not smoke.

Always shut off the engine before refueling.

Do not fuel a hot engine – **fuel may spill and cause a fire.**

Open the fuel cap carefully to allow any pressure build-up in the tank to release slowly and avoid fuel spillage.

Fuel your power tool only in well-ventilated areas. If you spill fuel, wipe the machine immediately – if fuel gets on your clothing, change immediately.

Your power tool comes standard with either a screw-type or bayonet-type fuel cap.



After fueling, tighten down the screw-type fuel cap as securely as possible.



Insert the fuel cap with hinged grip (bayonet-type cap) correctly in the opening, turn it clockwise as far as stop and fold the grip down.

This reduces the risk of unit vibrations causing the fuel cap to loosen or come off and spill quantities of fuel.

To reduce the risk of serious or fatal burn injuries, check for fuel leakage. If fuel leakage is found, do not start or run the engine until leak is fixed.

Before Starting

Check that your power tool is properly assembled and in good condition – refer to appropriate chapters in the instruction manual.

- Check the fuel system for leaks, paying special attention to visible parts such as the tank cap, hose connections and the manual fuel pump (on machines so equipped). If there are any leaks or damage, do not start the engine – **risk of fire**. Have your machine repaired by a servicing dealer before using it again.
- Correctly mounted guide bar
- Correctly tensioned chain
- Slide control / stop switch must move easily to **STOP** or **0**.
- Smooth action of throttle trigger lockout (if fitted) and throttle trigger – the throttle trigger must return automatically to the idle position.

- Check that the spark plug boot is secure – a loose boot may cause arcing that could ignite combustible fumes **and cause a fire**.
- Never attempt to modify the controls or safety devices in any way.
- Keep the handles dry and clean – free from oil and dirt – for safe control of the power tool.
- Adjust the harness to suit your height and reach. See chapter on "Fitting the Harness".

To reduce the risk of accidents, do not operate your power tool if it is damaged or not properly assembled.

If you use a shoulder strap or full harness: Practice removing and putting down the machine as you would in an emergency. To avoid damage, do not throw the machine to the ground when practicing.

Starting the Engine

Start the engine at least 3 meters from the fueling spot, outdoors only.

Place the unit on firm ground in an open area. Make sure you have good balance and secure footing. Hold the unit securely. The chain must be clear of the ground and all other obstructions because it may begin to run when the engine starts.

Your power tool is designed to be operated by one person only. **To reduce the risk of injury**, do not allow other persons within 15 meters of your own position – even when starting.

Start the engine as described in the instruction manual.

Note that the chain continues to run for a short period after you let go of the throttle trigger (flywheel effect).

Check idle speed setting: The chain must not move when the engine is idling with the throttle trigger released.

To reduce the risk of fire, keep hot exhaust gases and hot muffler away from easily combustible materials (e.g. wood chips, bark, dry grass, fuel).

Holding and Controlling the Power Tool



Always hold the unit **firmly with both hands** – right hand on the control handle, left hand on the drive tube – even if you are left-handed. Wrap your fingers around the control handle and drive tube.

Machines with telescoping shaft: Only extend the telescoping shaft as far as necessary for the cutting work that needs to be done.

During Operation

Make sure you always have good balance and secure footing.

In the event of impending danger or in an emergency, switch off the engine immediately by moving the slide control / stop switch to **STOP** or **0**.



This power tool is not insulated against electric shock. To reduce the **risk of electrocution** maintain a minimum clearance of 15 meters from electric power lines.

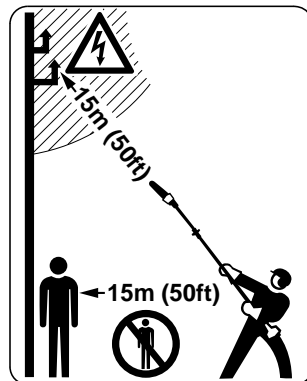

To reduce the risk of injury from falling objects and thrown pieces of wood, do not allow any other persons within a radius of 15 meters of your own position.

To reduce the risk of damage to property, also maintain this distance from other objects (vehicles, windows).

Maintain a minimum clearance of 15 meters between the bar nose and electric power lines. Electricity can jump considerable distances by means of arcing. Higher voltage increases the distance electricity can arc. Have the power switched off before starting cutting work in the immediate vicinity of power lines.

To reduce the risk of injury, shut off the engine before changing the saw chain.

Make sure the idle speed setting is correct. The chain must not run when the engine is idling with the throttle trigger released.

If the chain still rotates, have your dealer make proper adjustments or repairs. Check and correct the idle speed setting regularly.

Never leave a running power tool unattended.

Take special care in slippery conditions (ice, wet ground, snow) – on slopes or uneven ground.

Watch out for obstacles: Roots and tree stumps which **could cause you to trip or stumble**.

When working at heights:

- Always use a lift bucket
- Never work on a ladder or in a tree
- Never work on an insecure support
- Never operate your power tool with one hand

Be particularly alert and cautious when wearing hearing protection because your ability to hear warnings (shouts, alarms, etc.) is restricted.

To reduce the risk of accidents, take a break in good time to avoid tiredness or exhaustion.

Work calmly and carefully – in daylight conditions and only when visibility is good. Stay alert so as not to endanger others.



Your power tool produces toxic exhaust fumes as soon as the engine is running. These fumes may be colorless and odorless and contain unburned hydrocarbons and benzol. Never run the engine indoors or in poorly ventilated locations, even if your model is equipped with a catalytic converter.

To reduce the risk of serious or fatal injury from breathing toxic fumes, ensure proper ventilation when working in trenches, hollows or other confined locations.

To reduce the risk of accidents, stop work immediately in the event of nausea, headache, visual disturbances (e.g. reduced field of vision), problems with hearing, dizziness, deterioration in ability to concentrate. Apart from other possibilities, these symptoms may be caused by an excessively high concentration of exhaust gases in the work area.

Operate your power tool so that it produces a minimum of noise and emissions – do not run the engine unnecessarily, accelerate the engine only when working.

To reduce the risk of fire, do not smoke while operating or standing near your power tool. Note that combustible fuel vapor may escape from the fuel system.

The dusts (e.g. sawdust), vapor and smoke produced during operation may be dangerous to health. If dust levels are very high, wear a suitable respirator.

If your power tool is subjected to unusually high loads for which it was not designed (e.g. heavy impact or a fall), always check that it is in good condition before continuing work – see also "Before Starting". Check the fuel system in particular for leaks and make sure the safety devices are working properly. Do not continue operating your power tool if it is damaged. In case of doubt, consult your servicing dealer.

If you use a shoulder strap, make sure exhaust gases are diverted away from your body since there is otherwise **a risk of fire**.

Limbing

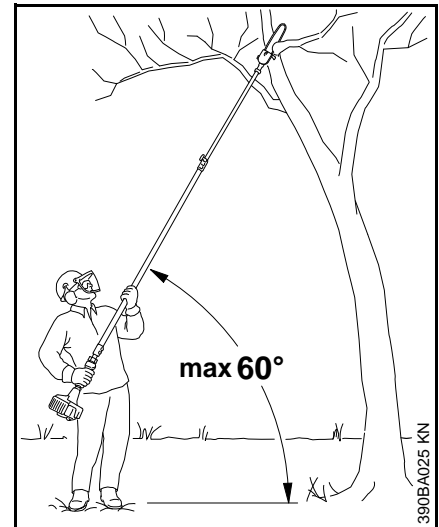

Hold the pole pruner at an angle. Do not stand directly underneath the limb being cut. Do not exceed an angle of 60° from the horizontal. Watch for falling wood.

Keep the work area clear – remove interfering limbs and brush.

Before limbing, establish a path of escape and remove all obstacles.

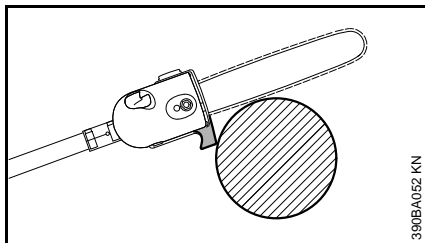

Position the cutting attachment with the hook against the branch and then perform the cross-cut. This reduces the risk of the pruner being jerked forward as you start the cross-cut.

Always start the cut with the engine at full throttle.

Always cut with a correctly sharpened, properly tensioned chain – the depth gauge setting must not be too large.

Do not operate your power tool in the starting throttle position – engine speed cannot be controlled in this position.

Perform cross-cut from the top downward to avoid the chain pinching in the cut.

If branch is thick or heavy, make a relieving cut – see chapter on "Using the Pole Pruner".

To reduce the risk of injury, take special care when cutting branches under tension. Always make a relieving cut on the compression side first and then perform the bucking cut at the tension side.

To reduce the risk of injury, take special care when cutting shattered wood because of the risk of injury from splinters being caught and thrown in your direction.

If on a slope, stand on the uphill side or to one side of the branch to be cut. Watch out for rolling branches.

Note when reaching the end of a cut that the unit is no longer supported by the guide bar in the cut. You have to take the full weight of the machine since **it might otherwise go out of control**.

Always pull the unit out of the cut with the chain running.

To reduce the risk of accidents, use your pole pruner for limbing and pruning only. It is not designed for felling.

Make sure your saw chain does not touch any foreign materials: Stones, nails, etc. may be flung off and damage the saw chain.

If the rotating chain makes contact with a rock or other solid object there is a risk of sparking which may cause easily combustible material to catch fire under certain circumstances. Dry plants and scrub are also easily combustible, especially in hot and dry weather conditions. If there is a risk of fire, do not use your pole pruner near combustible materials, dry plants or scrub. Always contact your local forest authority for information on a possible fire risk.

Before leaving the power tool unattended: Shut off the engine.

Vibrations

Prolonged use of the power tool may result in vibration-induced circulation problems in the hands (whitefinger disease).

No general recommendation can be given for the length of usage because it depends on several factors.

The period of usage is prolonged by:

- Hand protection (wearing warm gloves)
- Work breaks

The period of usage is shortened by:

- Any personal tendency to suffer from poor circulation (symptoms: frequently cold fingers, tingling sensations).
- Low outside temperatures.
- The force with which the handles are held (a tight grip restricts circulation).

Continual and regular users should monitor closely the condition of their hands and fingers. If any of the above symptoms appear (e.g. tingling sensation in fingers), seek medical advice.

Maintenance and Repairs

Service the machine regularly. Do not attempt any maintenance or repair work not described in the instruction manual. Have all other work performed by a servicing dealer.

STIHL recommends that you have servicing and repair work carried out exclusively by an authorized STIHL servicing dealer. STIHL dealers are regularly given the opportunity to attend training courses and are supplied with the necessary technical information.

Only use high-quality replacement parts in order to avoid the risk of accidents and damage to the machine. If you have any questions in this respect, consult a servicing dealer.

STIHL recommends the use of genuine STIHL replacement parts. They are specifically designed to match your model and meet your performance requirements.

To reduce the risk of injury, **always shut off the engine** before carrying out any maintenance or repairs or cleaning the machine. – Exception: Carburetor and idle speed adjustments.

Do not turn the engine over on the starter with the spark plug boot or spark plug removed unless the slide control / stop switch is on **STOP** or **0** since there is otherwise a **risk of fire** from uncontained sparking.

To reduce the **risk of fire**, do not service or store your machine near open flames.

Check the fuel filler cap for leaks at regular intervals.

Use only a spark plug of the type approved by STIHL and make sure it is in good condition – see "Specifications".

Inspect the ignition lead (insulation in good condition, secure connection).

Check the condition of the muffler.

To reduce the **risk of fire and damage to hearing**, do not operate your machine if the muffler is damaged or missing.

Do not touch a hot muffler since **burn injury** will result.

Stopping the engine

- before checking chain tension.
- before retensioning the chain.
- before replacing the chain.
- before rectifying problems.

Observe sharpening instructions – keep the chain and guide bar in good condition at all times for safe and correct handling of the saw. The chain must be properly sharpened, tensioned and well lubricated.

Always change the chain, guide bar and sprocket in good time.

Store fuel and chain lubricant in properly labelled, safety-type canisters only.

When handling gasoline, avoid direct contact with the skin and avoid inhaling fuel vapour – **health risk**.

Using the Unit

Preparations

- Wear suitable protective clothing, observe safety precautions.
- Adjust telescoping shaft to the required length (HT 101, HT 131 only).
- Start the engine.
- Put on the shoulder strap.

Cutting Sequence

To allow branches a free fall, always cut the lower branches first. Prune heavy branches (large diameter) in several controllable pieces.



WARNING

Never stand directly underneath the branch you are cutting – be wary of falling branches. Note that a branch may spring back at you after it hits the ground – **risk of injury**.

Disposal

Do not throw cuttings into the garbage can – they can be composted.

Working Techniques

Hold the control handle with your right hand, and the shaft with your left hand. Your left arm should be extended to the most comfortable position.

HT 100, HT 130

Always hold the shaft with your left hand in the area of the handle hose.

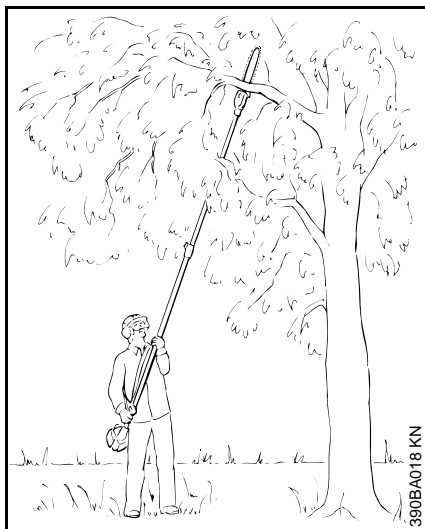

The shaft should always be held at an angle of **60° or less**.

The least tiring working position is a tool angle of 60°.

Any lesser angle may be used to suit the situation concerned.

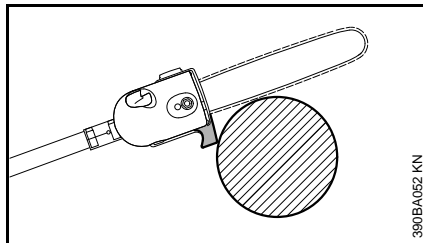
Cross-cut

To avoid pinching the bar in the cut, position the cutting attachment with the hook against the branch and then perform the cross-cut from the top downwards.

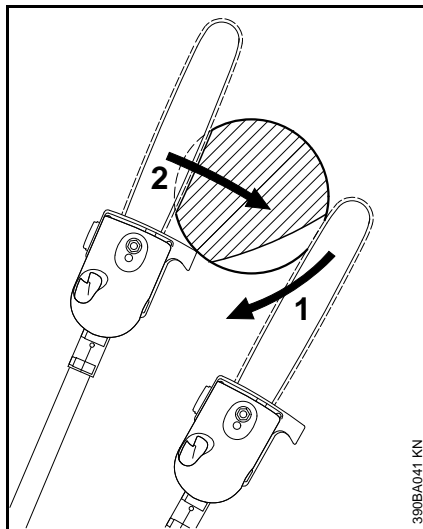
Relieving cut

To avoid tearing the bark on thick branches, always start by performing a relieving cut (1) on the underside of the branch.

- To do this, apply the cutting attachment and pull it across the bottom of the branch in an arc as far as the bar nose.
- Perform the cross-cut (2) – position the bar with the hook against the branch and then perform the cross-cut.

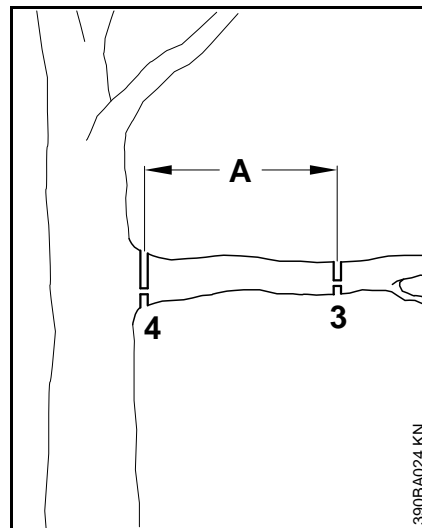
Flush-cutting thick branches

If branch diameter is more than 10 cm, first

- perform undercut (3) and then cross-cut at a distance of about 20 cm (A) from the final cut. Then carry out the flush-cut (4), starting with a relieving cut and finishing with a cross-cut.

Cutting above obstacles

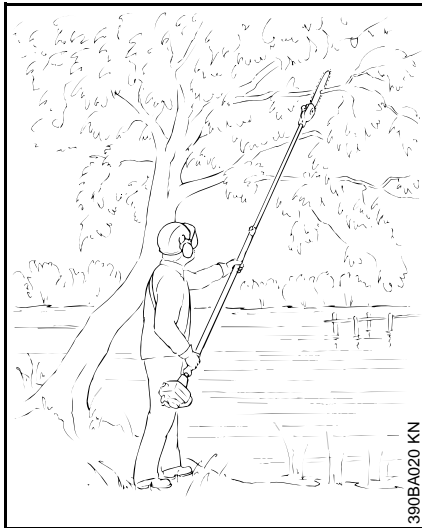

The unit's long reach makes it possible to prune branches that are overhanging obstacles, such as rivers or lakes. The tool angle in this case depends on the position of the branch.

Cutting from a lift bucket

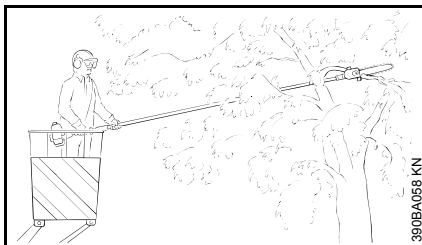

The unit's long reach enables cutting to be performed next to the trunk without the risk of the lift bucket damaging other branches. The tool angle in this case depends on the position of the branch.

30° angle drive (special accessory)

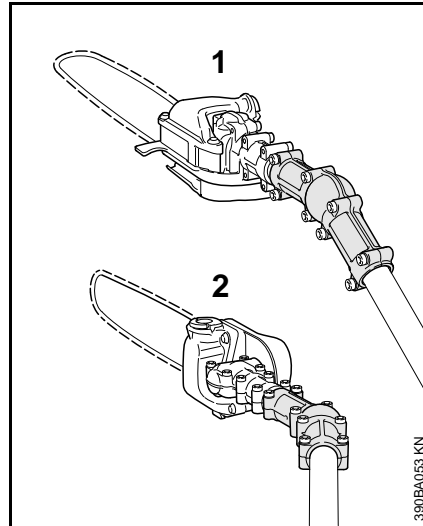

The angle drive keeps the cutting attachment at an angle of 30° to the drive tube.

The angle drive may be adjusted on the drive tube to the following positions only:

- 1 For cross-cutting vertical branches and bushes.
- 2 For a better view of the cutting attachment.

Cutting Attachment

A cutting attachment consists of the saw chain, guide bar and chain sprocket.

The cutting attachment that comes standard is designed to exactly match the pole pruner.

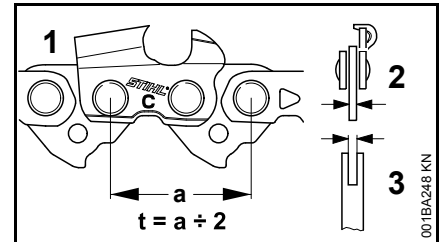

- The pitch (t) of the saw chain (1), chain sprocket and the nose sprocket of the Rollomatic guide bar must match.
- The drive link gauge (2) of the saw chain (1) must match the groove width of the guide bar (3).

If non-matching components are used, the cutting attachment may be damaged beyond repair after a short period of operation.

Chain Scabbard

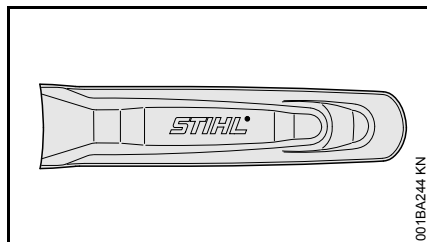

The scope of supply includes a bar scabbard that matches the cutting attachment.

If guide bars of different lengths are mounted to the pole pruner, always use a chain scabbard of the correct length which covers the complete guide bar.

The length of the matching guide bars is marked on the side of the chain scabbard.

Mounting the Bar and Chain

Removing the chain sprocket cover

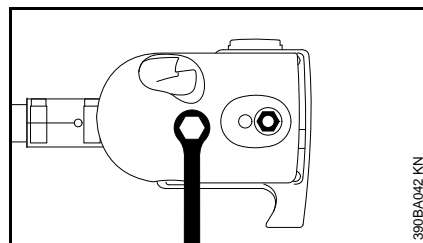

- Unscrew the nut and remove the cover.

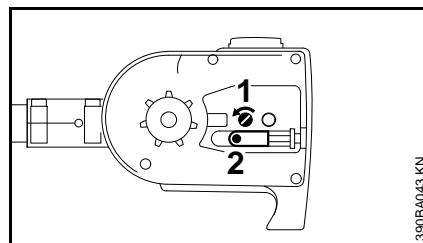

- Turn the screw (1) counterclockwise until the tensioner slide (2) butts against the left end of the housing slot, then back it off 5 full turns.

Fitting the chain

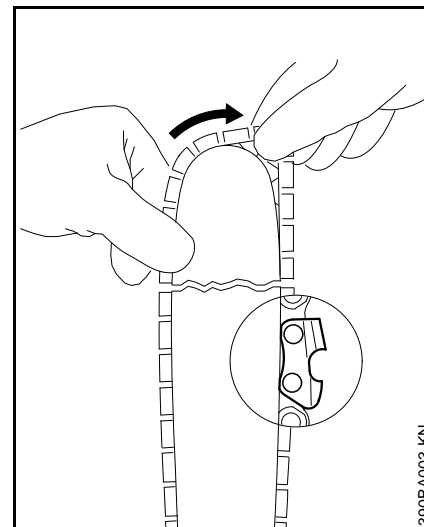

! WARNING

Wear work gloves to protect your hands from the sharp cutters.

- Fit the chain – start at the bar nose.

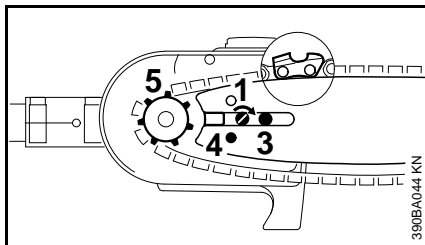

- Fit the guide bar over the screw (3) and engage peg of tensioner slide in the hole (4) – place the chain over the sprocket (5) at the same time.
- Turn the tensioning screw (1) clockwise until there is very little chain sag on the underside of the bar – and the drive link tangs are engaged in the bar groove.
- Refit the cover and screw on the nut fingertight.
- Go to chapter on "Tensioning the Saw Chain"

Tensioning the Chain

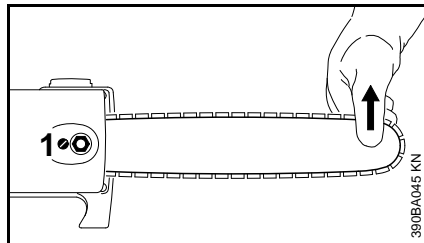

Retensioning during cutting work:

- Stopping the engine
- Loosen the nut.
- Hold the bar nose up.
- Use a screwdriver to turn the tensioning screw (1) clockwise until the chain fits snugly against the underside of the bar.
- While still holding the bar nose up, tighten down the nut firmly.
- Go to "Checking Chain Tension".

A new chain has to be retensioned more often than one that has been in use for some time.

- Check chain tension frequently – see chapter on "Operating Instructions".

Checking Chain Tension

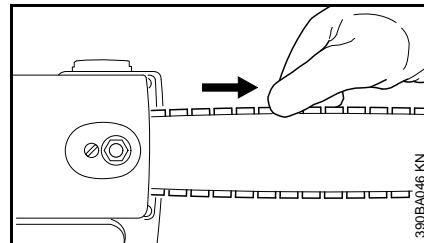

- Shut off the engine
- Wear work gloves to protect your hands.
- The chain must fit snugly against the underside of the bar and it must still be possible to pull the chain along the bar by hand.
- If necessary, retension the chain.

A new chain has to be retensioned more often than one that has been in use for some time.

- Check chain tension frequently – see chapter on "Operating Instructions".

Adjusting the Throttle Cable

A properly adjusted throttle cable is the precondition for correct operation in the starting throttle, idle and full throttle positions.

Adjust the throttle cable only when the machine is completely and properly assembled.

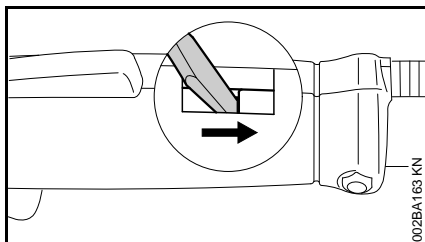

- Use a suitable tool to push the slide to the end of the slot (see illustration).

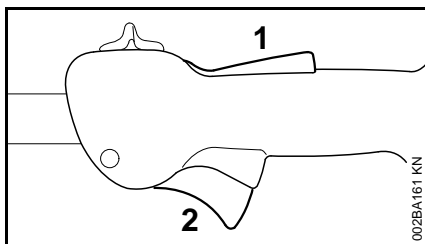

- Press down the trigger lockout (1) and squeeze the throttle trigger (2) (full throttle position) – this sets the throttle cable correctly.

Fuel

Your engine requires a mixture of gasoline and engine oil.



WARNING

For health reasons, avoid direct skin contact with gasoline and avoid inhaling gasoline vapor.

STIHL MotoMix

STIHL recommends the use of STIHL MotoMix. This ready-to-use fuel mix contains no benzol or lead, has a high octane rating and ensures that you always use the right mix ratio.

STIHL MotoMix uses STIHL HP Ultra two-stroke engine oil for an extra long engine life.

MotoMix is not available in all markets.

Mixing Fuel



NOTICE

Unsuitable fuels or lubricants or mix ratios other than those specified may result in serious damage to the engine. Poor quality gasoline or engine oil may damage the engine, sealing rings, hoses and the fuel tank.

Gasoline

Use only high-quality **brand-name** gasoline with a minimum octane rating of 90 – leaded or unleaded.

If your machine is equipped with a catalytic converter, you must use unleaded gasoline.



NOTICE

A few tankfuls of leaded gasoline will greatly reduce the efficiency of the catalytic converter.

Gasoline with an ethanol content of more than 10% can cause running problems in engines with a manually adjustable carburetor and should not be used in such engines.

Engines equipped with M-Tronic deliver full power when run on gasoline with an ethanol content of up to 25% (E25).

Engine oil

Use only high-quality two-stroke engine oil – preferably **STIHL HP, HP Super or HP Ultra, which are specially formulated for use in STIHL engines. HP Ultra guarantees high performance and a long engine life.**

These engine oils are not available in all markets.

Use only **STIHL 50:1 two-stroke engine oil** for the fuel mix in models with a catalytic converter.

Mix Ratio

STIHL 50:1 two-stroke engine oil: 50 parts gasoline to 1 part oil

Examples

Gasoline	STIHL engine oil 50:1	
Liters	Liters	(ml)
1	0.02	(20)
5	0.10	(100)
10	0.20	(200)
15	0.30	(300)
20	0.40	(400)
25	0.50	(500)

- Use a canister approved for storing fuel. Pour oil into canister first, then add gasoline and mix thoroughly.

Storing Fuel

Store fuel only in approved safety-type fuel canisters in a dry, cool and safe location protected from light and the sun.

Fuel mix ages – only mix sufficient fuel for a few weeks work. Do not store fuel mix for longer than 30 days. Exposure to light, the sun, low or high temperatures can quickly make the fuel mix unusable.

STIHL MotoMix may be stored for up to 2 years without any problems.

- Thoroughly shake the mixture in the canister before fueling your machine.

WARNING

Pressure may build up in the canister – open it carefully.

- Clean the fuel tank and canister from time to time.

Dispose of remaining fuel and cleaning fluid properly in accordance with local regulations and environmental requirements.

Fueling



Preparations

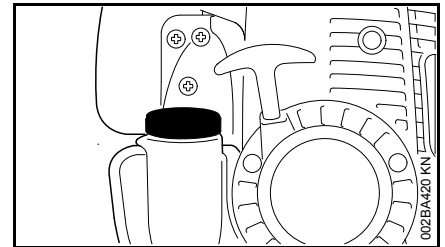

- Before fueling, clean the filler cap and the area around it so that dirt cannot fall into the tank.
- Always position the machine so that the filler cap is facing upwards.

A number of different filler caps are installed as standard at the factory.

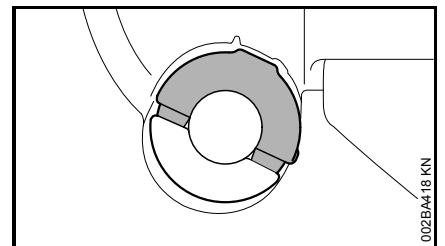

Cliplock filler cap (bayonet-type)

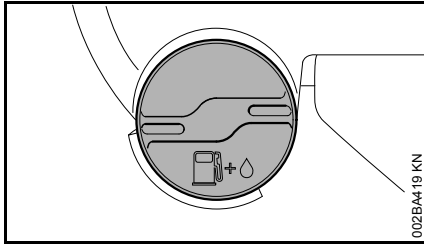

Threaded filler cap

Opening the cliplock filler cap

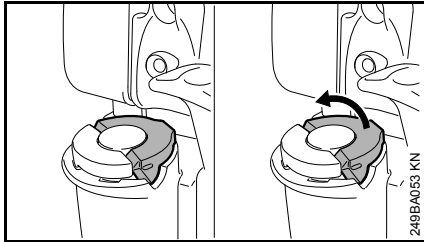

- Swing the clip into an upright position

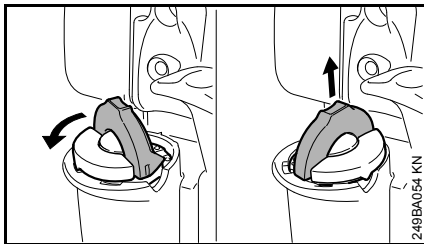

- Turn the cap counterclockwise (approx. 1/4 turn)
- Remove the filler cap

Refueling

Take care not to spill fuel while fueling and do not overfill the tank. STIHL recommends use of the STIHL filling system (special accessory).

Closing the cliplock filler cap

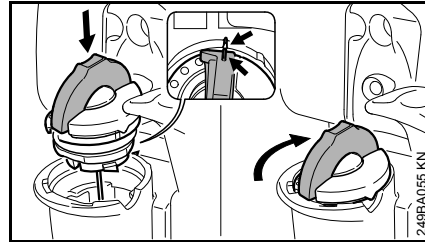

- Position the cap with the clip in an upright position; the markings must line up
- Turn cap clockwise as far as it will go (approx. 1/4 turn)

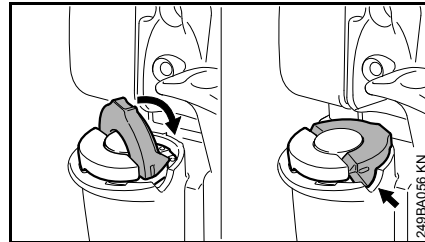

- Fold the cliplock down so that it is flush with the surface

If the cliplock is not flush with the surface and the lug on the clip does not engage entirely in the recess (arrow), the cap is not properly closed and the steps described above must be repeated.

Opening screw-type tank cap

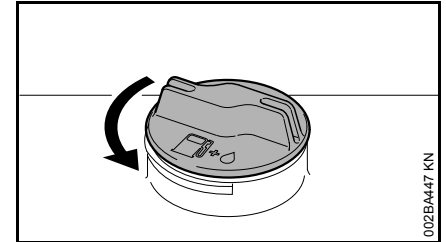

- Turn the cap counterclockwise until it can be removed from the tank opening.
- Remove the cap.

Filling up with fuel

Take care not to spill fuel while fueling and do not overfill the tank. STIHL recommends you use the STIHL filler nozzle (special accessory).

Closing screw-type tank cap

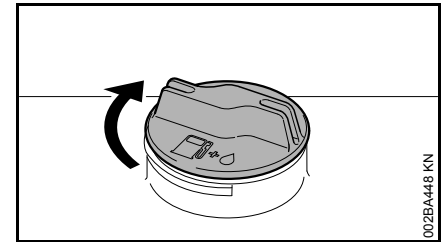

- Place the cap in the opening.
- Turn the cap clockwise as far as stop and tighten it down as firmly as possible by hand.

Chain Lubricant

For automatic and reliable lubrication of the chain and guide bar – use only an environmentally compatible quality chain and bar lubricant. Rapidly biodegradable STIHL BioPlus is recommended.



NOTICE

Biological chain oil must be resistant to aging (e.g. STIHL BioPlus), since it will otherwise quickly turn to resin. This results in hard deposits that are difficult to remove, especially in the area of the chain drive and chain. It may even cause the oil pump to seize.

The service life of the chain and guide bar depends on the quality of the lubricant. It is therefore essential to use only a specially formulated chain lubricant.



WARNING

Do not use waste oil. Renewed contact with waste oil can cause skin cancer. Moreover, waste oil is environmentally harmful.



NOTICE

Waste oil does not have the necessary lubricating properties and is unsuitable for chain lubrication.

Filling Chain Oil Tank



NOTICE

A full chain oil tank is sufficient for only half a tankful of fuel. Check the oil level regularly during cutting work. Never allow the oil tank to run dry.

Preparations

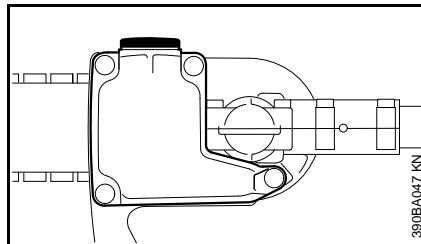

- Thoroughly clean the oil filler cap and the area around it to ensure that no dirt falls into the tank.
- Position the machine so that the tank cap faces up.

Opening

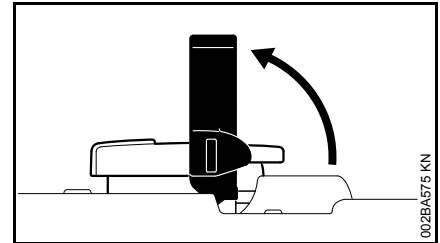

- Raise the grip until it is upright.

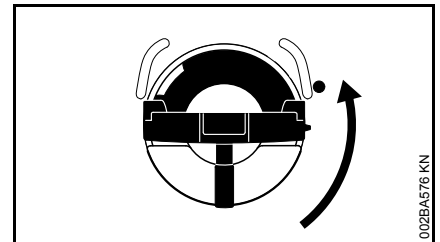

- Turn the cap counterclockwise (about a quarter turn).

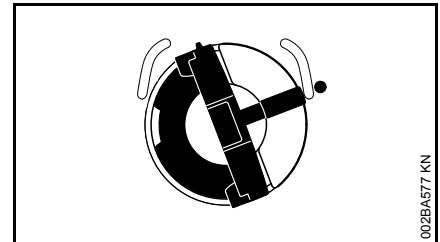

Marks on tank cap and oil tank must line up.

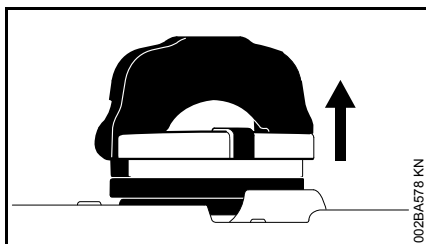

- Remove the cap.

Filling the chain oil tank

- Fill up with chain oil

Take care not to spill chain oil while refilling and do not overfill the tank.

STIHL recommends you use the STIHL filler nozzle for chain oil (special accessory).

Closing

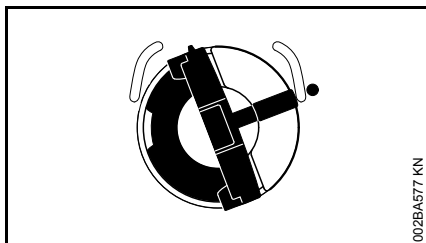

Grip must be vertical:

- Fit the cap – marks on tank cap and oil tank must line up.
- Press the cap down as far as stop.

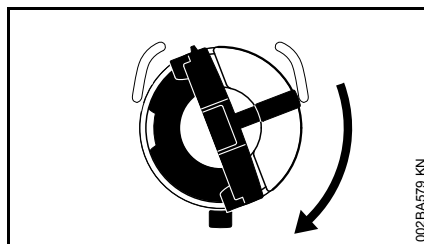

- While holding the cap depressed, turn it clockwise until it engages in position.

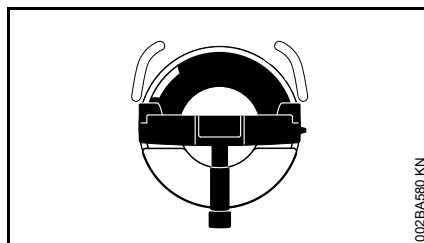

The marks on the cap and oil tank are then in alignment.

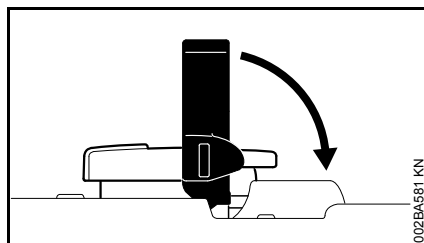

- Fold the grip down.

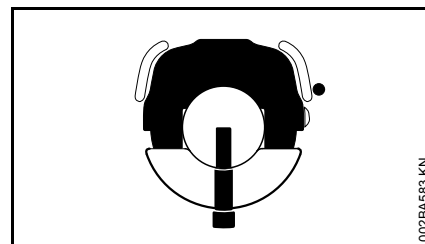

Tank cap is locked.

If the oil level in the tank does not go down, the reason may be a problem in the oil supply system: Check chain lubrication, clean the oilways, contact your dealer for assistance if necessary. STIHL recommends that you have servicing and repair work carried out exclusively by an authorized STIHL servicing dealer.

If the tank cap cannot be locked in the oil tank opening

Bottom of cap is twisted in relation to top.

- Remove the cap from the oil tank and check it from above.

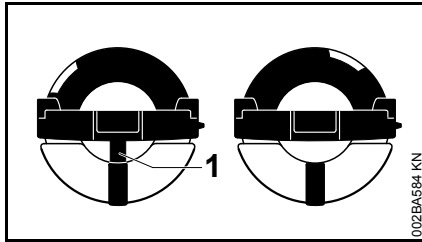

002BA584 KN

Left: Bottom of cap is twisted – inner mark (1) in line with outer mark.

Right: Bottom of cap in correct position – inner mark is under the grip. It is not in line with the outer mark.

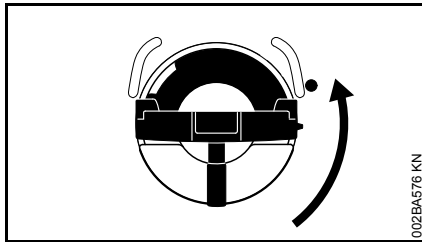

002BA576 KN

- Place the cap on the opening and rotate it counterclockwise until it engages the filler neck.
- Continue rotating the cap counterclockwise (about a quarter turn) – this causes the bottom of the cap to be turned to the correct position.
- Turn the cap clockwise and lock it in position – see section on "Closing".

Checking Chain Lubrication

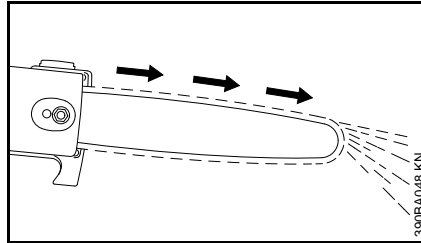

390BA048 KN

The saw chain must always throw off a small amount of oil.

NOTICE

Never operate your saw without chain lubrication. If the chain runs dry, the whole cutting attachment will be irretrievably damaged within a very short time. Always check chain lubrication and the oil level in the tank before starting work.

Every new chain has to be broken in for about 2 to 3 minutes.

After breaking in the chain, check chain tension and adjust if necessary – see "Checking Chain Tension".

Adjusting the Telescoping Shaft

HT 101, HT 131 only

WARNING

Always shut off the engine and fit the chain guard

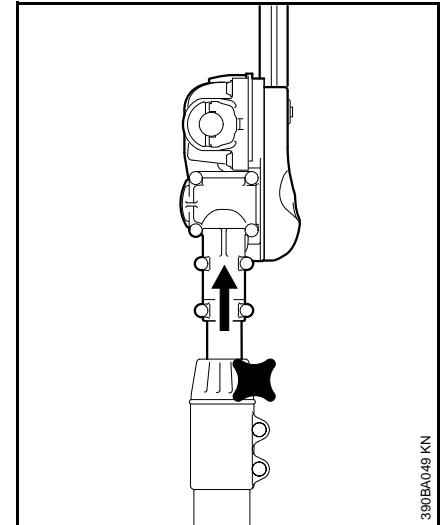

390BA049 KN

- Loosen the screw.
- Adjust shaft to the required length.
- Tighten down the screw firmly.

Fitting the Harness

The type and style of the harness depend on the market.

Shoulder strap

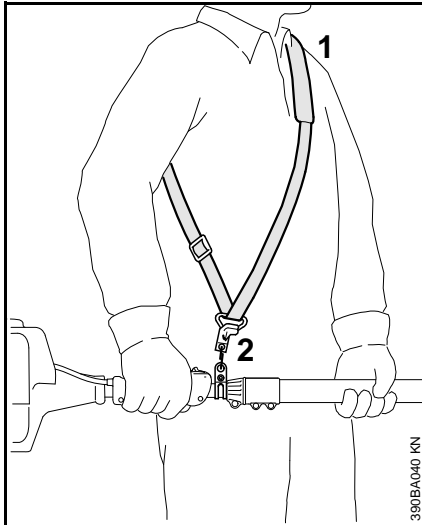

- Put on the shoulder strap (1).
- Adjust the length of the strap.
- With the power tool attached, the carabiner (2) must be at about the same height as your right hip.

Full harness (HT 100, HT 101 only)

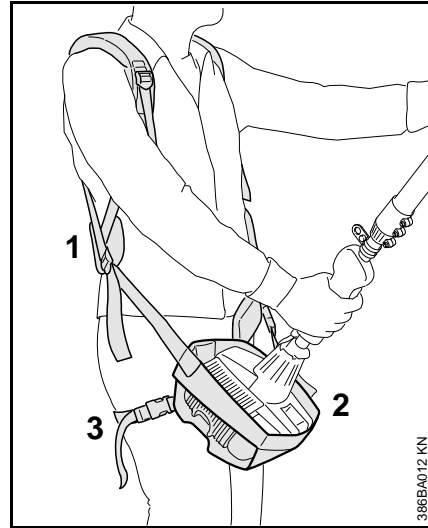

- Put on the full harness (1) and sling (2) as described in the instruction sheet provided.
- Adjust the harness and thigh strap (3) as required.
- Rest the powerhead in the sling during cutting work.

Backpack Carrying System

HT 100, HT 130 only

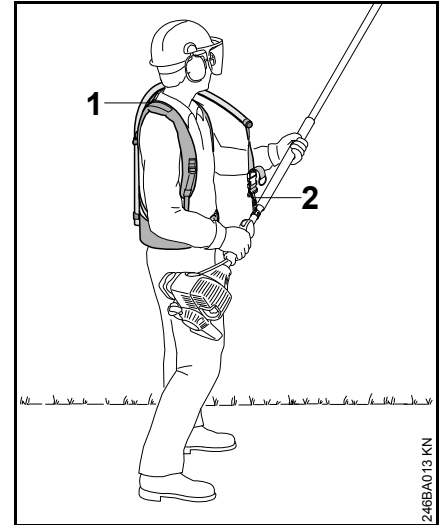

- Put the backpack carrying system (1) on your back and adjust it as described in the instruction sheet provided.
- Attach the carabiner (2) to the machine's carrying ring.
- Attach the pole pruner to the carrying strap when cutting.

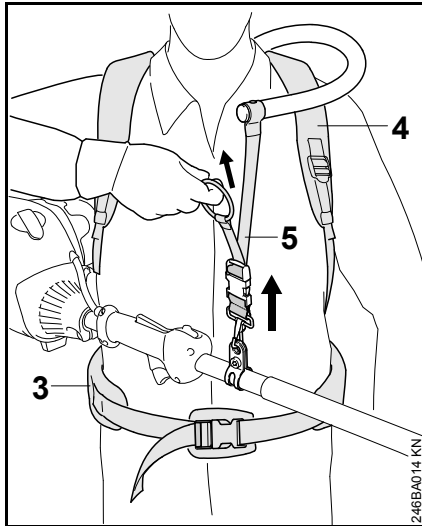

- Adjust the hip belt (3), both shoulder straps (4) and the carrying strap (5).

HT 101, HT 131 only

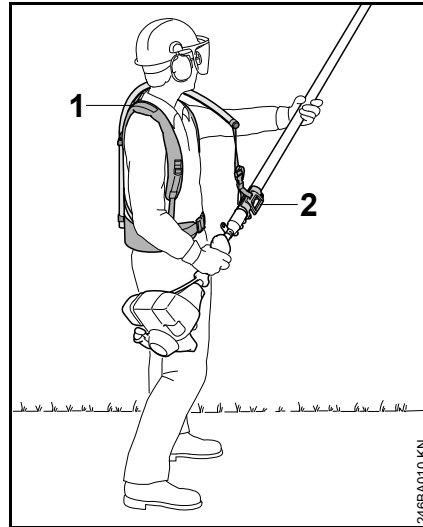

- Put the backpack carrying system (1) on your back and adjust it as described in the instruction sheet provided.
- Secure the sliding adjuster (2) to the shaft.
- Attach the pole pruner to the carrying strap when cutting.

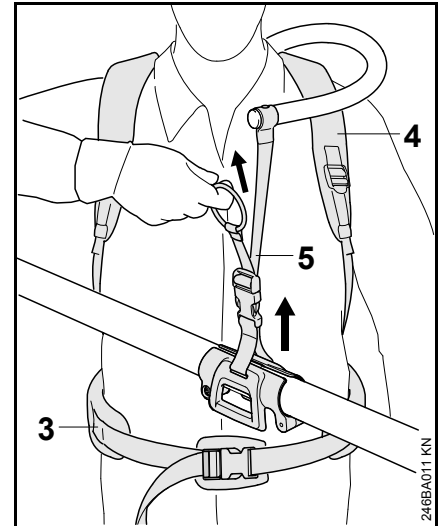

- Adjust the hip belt (3), both shoulder straps (4) and the carrying strap (5).

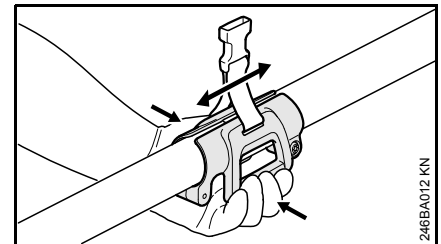

- Squeeze the grips to move the sliding adjuster up or down the shaft.

Starting / Stopping the Engine

Controls

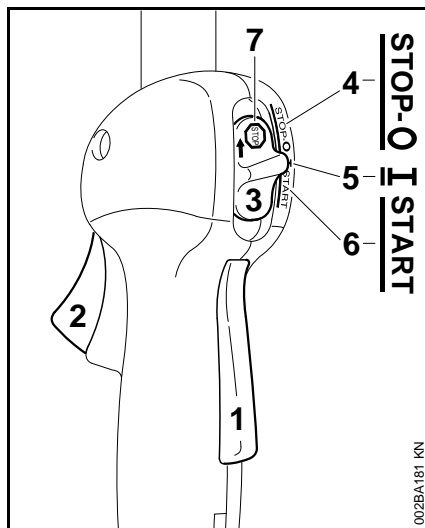



- 1 Throttle trigger lockout
- 2 Throttle trigger
- 3 Slide control

Positions of slide control

- 4 **STOP-0** – engine off – ignition is switched off
- 5 **I** – normal run position – the engine is running or can start
- 6 **START** – ignition is switched on – the engine can start

Symbol on slide control



- 7  – stop symbol and arrow. To stop the engine, push the slide control in the direction of the arrow on the stop symbol () to **STOP-0**.

Starting

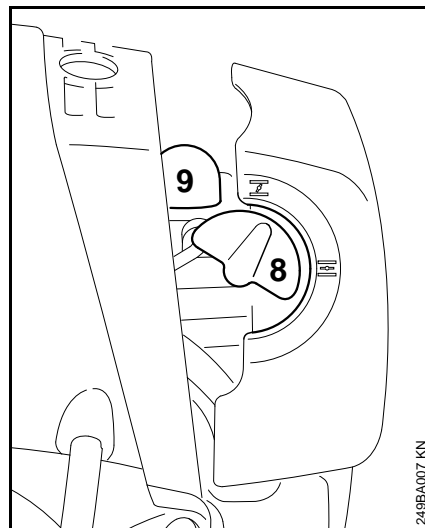
- Press down the trigger lockout lever and squeeze the throttle trigger
- and hold them in that position.
- Move the slide control to **START** and hold it there.
- Now release the throttle trigger, slide control and trigger lockout in that order. This is the **starting throttle position**.



- Set the choke knob (8):

-  if the engine is cold
-  for warm start – also use this position if the engine has been running but is still cold.

- Press the manual fuel pump bulb (9) at least five times – even if the bulb is filled with fuel.

Cranking

- Remove the chain scabbard. Check that the chain is not touching the ground or any other obstacles.

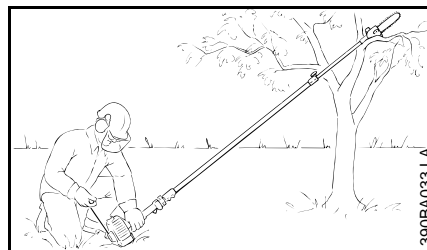

- Place the unit on the ground: It must rest securely on the engine support and the hook. If necessary, rest the hook on a raised support (e.g. a branch, mound or something similar).

WARNING

Check that nobody is standing within the working range of the pruner.

- Make sure you have a safe and secure footing.
- Hold the unit with your left hand on the fan housing and press it down **firmly** – your thumb should be under the fan housing.

NOTICE

Do not stand or kneel on the drive tube. This will bend the drive tube and may result in permanent damage.

Alternative method:

- Remove the chain scabbard. Position the drive tube on a branch so that it is held by the hook.

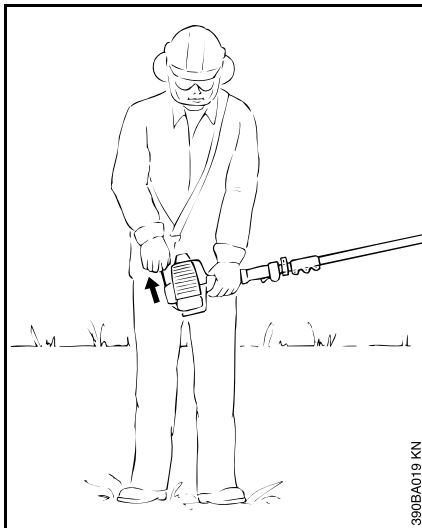

- Hold the unit **firmly** with your left hand on the fan housing – your thumb should be under the fan housing.
- Hold the starter grip with your right hand.
- Pull the starter grip slowly until you feel it engage and then give it a brisk strong pull.

NOTICE

Do not pull out the starter rope all the way – **it might otherwise break.**

- Do not let the starter grip snap back. Guide it slowly back into the housing so that the starter rope can rewind properly.
- Crank the engine until it begins to fire. After no more than **five attempts**, turn the choke knob to .
- Continue cranking.

As soon as the engine runs

- Blip the throttle trigger. The slide control moves to the normal run position **I** – and the engine settles down to idle speed.

WARNING

Make sure the carburetor is correctly adjusted. The saw chain must not rotate when the engine is idling.

Your machine is now ready for operation.

Stopping the engine

- Push the slide control in the direction of the arrow on the stop symbol () to **STOP-0**.

At very low outside temperatures

As soon as the engine runs:

- Blip the throttle trigger to disengage the **starting throttle position**. The slide control moves to the normal run **I** – and the engine settles down to idle speed.
- Open the throttle slightly.
- Warm up the engine for a short period.

If engine does not start

Choke knob

If you did not turn the choke knob to  quickly enough after the engine began to fire, the combustion chamber is flooded.

- Turn the choke knob to .
- Set the slide control, lockout lever and throttle trigger to the **starting throttle position**.
- Start the engine by pulling the starter rope briskly – 10 to 20 pulls may be necessary.

If the engine still does not start

- Move the slide control to **STOP-0**.
- Remove the spark plug – see "Spark Plug".
- Dry the spark plug.
- Crank the engine several times with the starter to clear the combustion chamber.
- Refit the spark plug – see "Spark Plug".
- Move the slide control to **START**.

- Set the choke knob to  – even if the engine is cold.
- Now start the engine.

Throttle cable adjustment

- Check adjustment of throttle cable – see chapter on "Adjusting the Throttle Cable".

Fuel tank run until completely dry

- After refueling, press the manual fuel pump bulb at least five times – even if the bulb is filled with fuel.
- Set the choke knob according to engine temperature.
- Start the engine.

Operating Instructions

During Break-In Period

A factory-new machine should not be run at high revs (full throttle off load) for the first three tank fillings. This avoids unnecessary high loads during the break-in period. As all moving parts have to bed in during the break-in period, the frictional resistances in the engine are greater during this period. The engine develops its maximum power after about 5 to 15 tank fillings.

During Operation



NOTICE

Do not make the mixture leaner to achieve an apparent increase in power – this could damage the engine – see "Adjusting the Carburetor".

Check chain tension frequently

A new chain has to be retensioned more often than one that has been in use for some time.

Chain cold

Tension is correct when the chain fits snugly against the underside of the bar and can still be pulled along the bar by hand. Retension if necessary – see "Tensioning the Saw Chain".

Chain at operating temperature

The chain stretches and begins to sag. The drive links must not come out of the bar groove – the chain may otherwise jump off the bar. Retension the chain – see "Tensioning the Saw Chain".



NOTICE

The chain contracts as it cools down. If it is not slackened off, it can damage the gear shaft and bearings.

After long period of full-throttle operation

Allow engine to run for a short while at idle speed so that engine heat can be dissipated by the flow of cooling air. This protects engine-mounted components (ignition, carburetor) from thermal overload.

After Finishing Work

- Slacken off the chain if you have retensioned it at operating temperature during cutting work.



NOTICE

Always slacken off the chain after finishing work. The chain contracts as it cools down. If it is not slackened off, it can damage the gear shaft and bearings.

Storing your saw for a short period

Fit the chain scabbard and allow engine to cool down. To avoid condensation, fill the fuel tank and keep the machine in a dry place, well away from sources of ignition, until you need it again.

Storing for a long period

See chapter on "Storing the Machine"

Taking Care of the Guide Bar

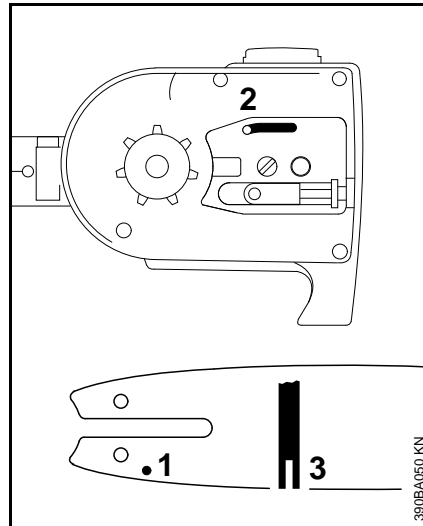

- Turn the bar over – every time you sharpen the chain and every time you replace the chain – this helps avoid one-sided wear, especially at the nose and underside of the bar.
- Regularly clean the oil inlet hole (1), the oilway (2) and the bar groove (3).
- Measure the groove depth – with the scale on the filing gauge (special accessory) – in the area used most for cutting.

Chain type	Chain pitch	Minimum groove depth
Picco	3/8" P	5.0 mm

If groove depth is less than specified:

- Replace the guide bar.

The drive link tangs will otherwise scrape along the bottom of the groove – the cutters and tie straps will not ride on the bar rails.

Cleaning the Air Filter

If there is a noticeable loss of engine power

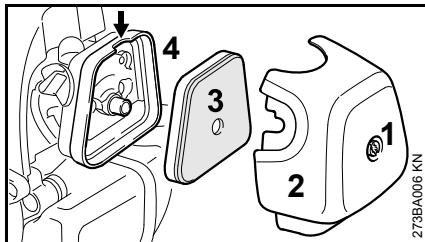

- Turn the choke knob to \bar{I}
- Take out the screw (1) and remove the filter cover (2).
- Clean away loose dirt from around the filter.
- Grip the filter element (3) at the cutout (arrow) in the filter housing (4) and remove it.
- Fit a new filter element. As a temporary measure you can knock it out on the palm of your hand or blow it out with compressed air. Do not wash.
- Replace damaged parts.

Installing the filter

- Install the filter element in the filter housing and fit the cover.
- Insert the screw and tighten it down firmly.

Adjusting the Carburetor

The carburetor comes from the factory with a standard setting.

This setting provides an optimum fuel-air mixture under most operating conditions.

With this carburetor it is only possible to adjust the high speed screw within fine limits.

Adjusting idle speed

Engine stops while idling

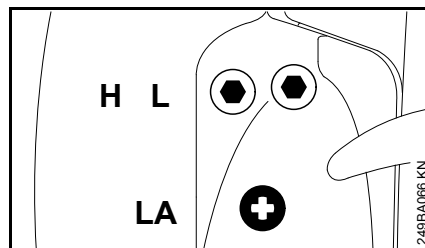

- Warm up the engine for about 3 minutes.
- Turn the idle speed screw (LA) slowly clockwise until the engine runs smoothly – the chain must not rotate.

Chain rotates when engine is idling

- Turn the idle speed screw (LA) counterclockwise until the chain stops running and then turn the screw about another 1/2 to 3/4 turn in the same direction.

! WARNING

If the chain continues moving when the engine is idling, have your machine checked and repaired by your servicing dealer.

Spark Arresting Screen in Muffler

In some countries the muffler is equipped with a spark arresting screen.

- If the engine is down on power, check the spark arresting screen in the muffler.
- Wait for the muffler to cool down.
- Move the slide control to **STOP-0**.

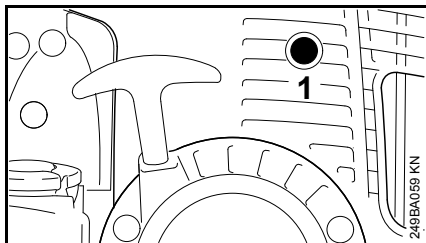

- Take out the screw (1).

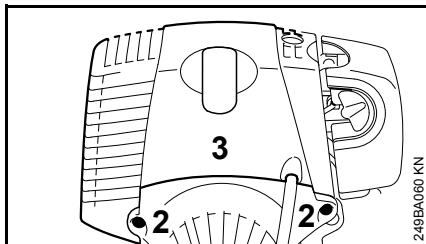

- Take out the screws (2) and remove the shroud (3).

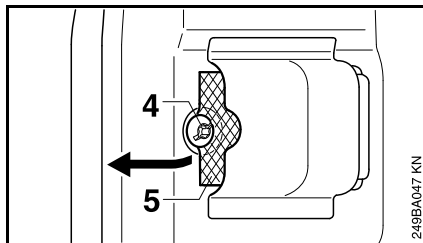

- Take out the screw (4).
- Lift the spark arresting screen (5) and pull it out.
- Clean the spark arresting screen. If the screen is damaged or heavily carbonized, fit a new one.
- Refit the spark arresting screen.
- Insert the screw and tighten it down firmly.
- Fit the shroud.

Spark Plug

- If the engine is down on power, difficult to start or runs poorly at idle speed, first check the spark plug.
- Fit a new spark plug after about 100 operating hours – or sooner if the electrodes are badly eroded. Install only suppressed spark plugs of the type approved by STIHL – see "Specifications".

Removing the spark plug

- Move the slide control to **STOP-0**.

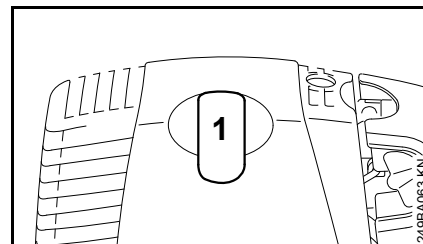

- Pull off the spark plug boot (1).
- Unscrew the spark plug.

Checking the Spark Plug

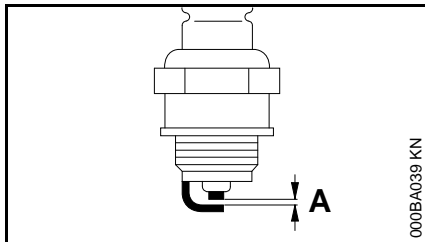

- Clean dirty spark plug.
- Check electrode gap (A) and readjust if necessary – see "Specifications".
- Rectify the problems which have caused fouling of the spark plug.

Possible causes are:

- Too much oil in fuel mix.
- Dirty air filter.
- Unfavorable running conditions.

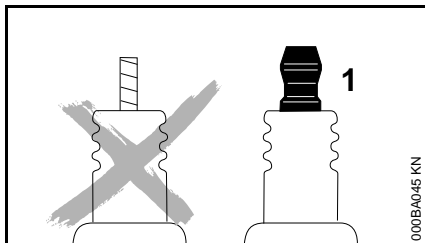

WARNING

Arcing may occur if the adapter nut (1) is loose or missing. Working in an easily combustible or explosive atmosphere may cause a fire or an explosion. This can result result in serious injuries or damage to property.

- Use resistor type spark plugs with a properly tightened adapter nut.

Installing the spark plug

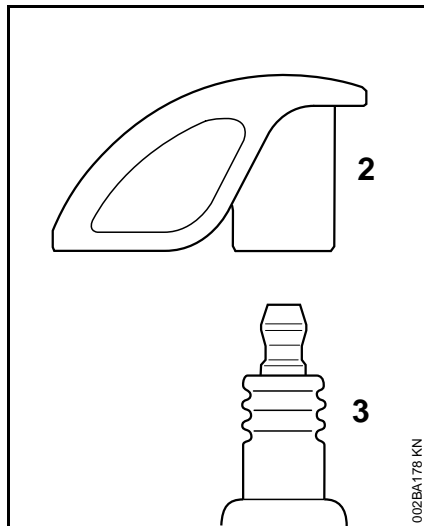

- Screw the spark plug (3) into the cylinder and fit the boot (2) (press it down firmly).

Storing the Machine

For periods of 3 months or longer

- Drain and clean the fuel tank in a well ventilated area.
- Dispose of fuel properly in accordance with local environmental requirements.
- Run the engine until the carburetor is dry – this helps prevent the carburetor diaphragms sticking together.
- Remove the saw chain and guide bar, clean them and spray with corrosion inhibiting oil.
- Thoroughly clean the machine – pay special attention to the cylinder fins and air filter.
- If you use a biological chain and bar lubricant, e.g. STIHL BioPlus, completely fill the chain oil tank.
- Store the machine in a dry, high or locked location, out of the reach of children and other unauthorized persons.

Checking and Replacing the Chain Sprocket

- Remove the chain sprocket cover, chain and guide bar.

Replace the chain sprocket

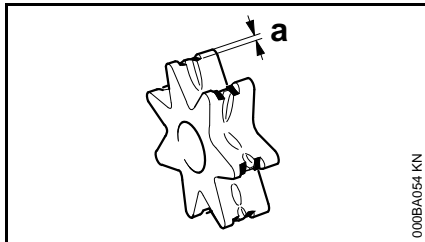

- after using two saw chains or sooner
- if the wear marks (a) on the sprocket are deeper than approx. 0.5 mm since this would reduce the life of the chain. You can use a gauge (special accessory) to check the depth of the wear marks.

It is best to use two saw chains in rotation with one sprocket.

STIHL recommends the use of original STIHL chain sprockets.

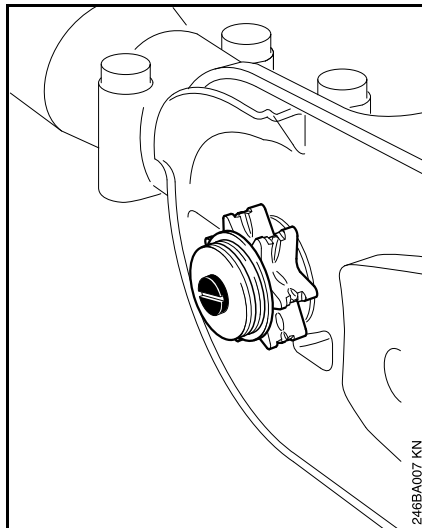

The chain sprocket is driven via a friction clutch. Have the chain sprocket replaced by a servicing dealer.

STIHL recommends that you have servicing and repair work carried out exclusively by an authorized STIHL servicing dealer.

Maintaining and Sharpening the Saw Chain

Cutting effortlessly with a correctly sharpened chain

A properly sharpened chain slices through wood effortlessly and requires very little feed pressure.

Do not work with a dull or damaged chain as it will increase the physical effort required, produce unsatisfactory results and a higher rate of wear.

- Clean the chain.
- Check the chain for cracks in the links and damaged rivets.
- Replace any damaged or worn parts of the chain and match the new parts to the shape and size of the original parts.

Carbide-tipped saw chains (Duro) are particularly wear resistant. STIHL recommends you have your chain resharpened by a STIHL servicing dealer.

WARNING

It is absolutely essential to comply with the angles and dimensions specified below. If the saw chain is incorrectly sharpened – and in particular if the depth gauge is set too low – there is an increased risk of kickback, with resulting **risk of injury**.

The saw chain cannot be locked in place on the guide bar. Therefore, it is best to remove the chain from the bar and resharpen it on a workshop sharpening tool (FG 2, HOS, USG).

Chain pitch

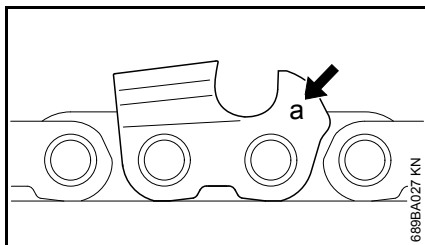

The chain pitch (a) is marked on the depth gauge end of each cutter.

Mark (a)	Chain pitch	
	inch	mm
7	1/4 P	6,35
1 or 1/4	1/4	6,35
6, P or PM	3/8 P	9,32
2 or 325	0.325	8,25
3 or 3/8	3/8	9,32

Select file diameter according to chain pitch – see table "Sharpening Tools".

You must observe certain angles when reshaping the chain cutter.

Filing and side plate angles

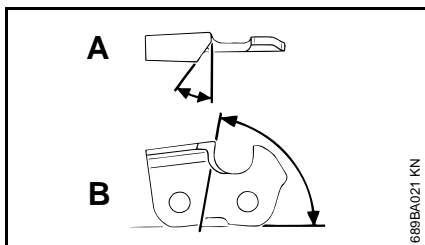

A Filing angle

STIHL saw chains are sharpened to a filing angle of 30°. Exceptions are ripping chains with a filing angle of 10°. Ripping chains have an X in their designations.

B Side plate angle

The correct side plate angle is obtained automatically if you use the prescribed file holder and file diameter.

Cutter shapes	Angle (°)	
	A	B
Micro = semi chisel cutter, e.g. 63 PM3, 26 RM3, 71 PM3	30	75

Super = chisel cutter, e.g. 63 PS3, 26 RS, 36 RS3

Ripping chain, e.g. 63 PMX, 36 RMX

The angles must be the same on all cutters. If the angles are uneven: Chain will run roughly, not in a straight line, wear quickly and finally break.

File holder

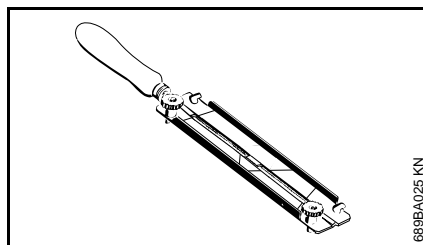

● Use a file holder

A file holder must be used for manual sharpening (see table "Sharpening Tools"). The correct filing angles are marked on the file holder.

Use only special saw chain sharpening files. Other files have the wrong shape and cut.

For checking angles

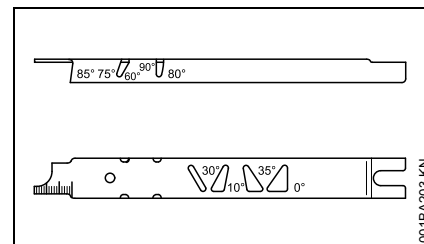

Use a STIHL filing gauge (special accessory, see table "Sharpening Tools"). This is a universal tool for checking the filing and side plate angles, depth gauge setting, cutter length and groove depth. It also cleans the guide bar groove and oil inlet holes.

File correctly

- Select sharpening tools according to chain pitch.
- If you use an FG 2, HOS or USG sharpener: Remove the chain from the bar and sharpen according to the instructions supplied with the tool.
- Clamp the bar in a vise if necessary.
- Sharpen the chain frequently, take away as little metal as possible – two or three strokes of the file are usually enough.

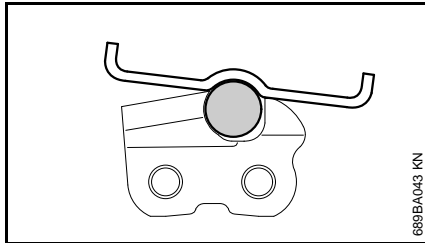
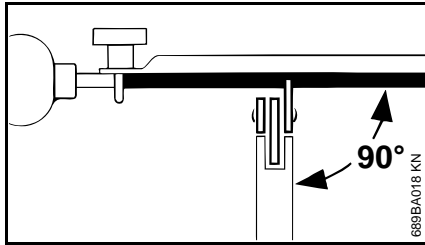

- Hold the file **horizontally** (at a right angle to the side of the guide bar) and file according to the angles marked on the file holder. Rest the file holder on the top plate and depth gauge.
 - Always file from the inside to the outside of the cutter.
 - The file only sharpens on the forward stroke – lift the file off the cutter on the backstroke.
 - Avoid touching the tie straps and drive links with the file.
 - Rotate the file at regular intervals while filing to avoid one-sided wear.
 - Use a piece of hardwood to remove burrs from the cutting edge.
 - Check angles with the filing gauge.
- All cutters must be the same length.

If the cutters are not the same length, they will have different heights. This makes the chain run roughly and can cause it to break.

- Find the shortest cutter and then file all other cutters back to the same length. It is best to have this work done by a servicing dealer on an electric grinder.

Depth gauge setting

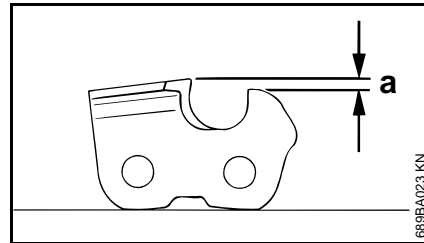

The depth gauge determines the height at which the cutter enters the wood and thus the thickness of the chip removed.

- a Specified distance or setting between depth gauge and cutting edge.

This setting may be increased by 0.2 mm (0.008") for cutting softwood in the mild weather season – no frost.

Chain pitch		Depth gauge Setting (a)	
inch	(mm)	mm	(inch)
1/4 P	(6,35)	0,45	(0.018)
1/4	(6,35)	0,65	(0.026)
3/8 P	(9,32)	0,65	(0.026)
0.325	(8,25)	0,65	(0.026)
3/8	(9,32)	0,65	(0.026)

Lowering depth gauges

The depth gauge setting is reduced when the chain is sharpened.

- Use a filing gauge to check the setting every time you sharpen the chain.

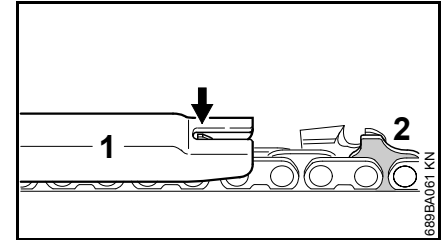

- Place a filing gauge (1) that matches the chain pitch on the chain and press it against the cutter – if the depth gauge projects from the filing gauge, the depth gauge has to be lowered.

Saw chains with humped drive link (2) – upper part of humped drive link (2) (with service mark) is lowered along with the depth gauge.

WARNING

The other parts of the humped drive link must not be filed since this may increase the kickback tendency of the power tool.

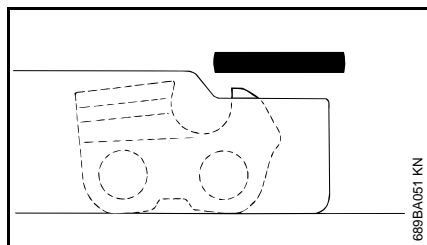

- File down the depth gauge until it is level with the filing gauge.

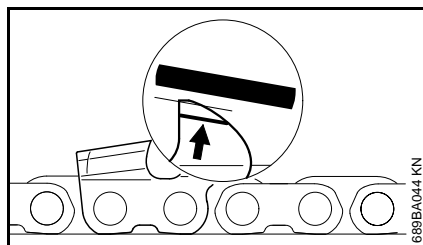

- File the top of the depth gauge parallel to the stamped service marking (see arrow) – but do not lower the highest point of the depth gauge in this process.

! WARNING

The kickback tendency of the machine is increased if the depth gauges are too low.

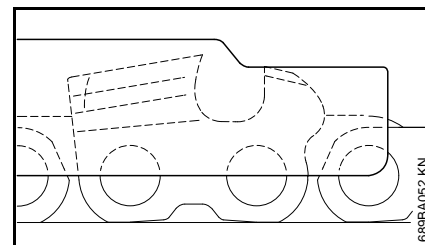

- Place the filing gauge on the chain – the highest point of the depth gauge must be level with the filing gauge.
- After sharpening, clean the chain thoroughly, remove filings or grinding dust – lubricate the chain thoroughly.
- Before a long out-of-service period, clean the chain and store it in a well-oiled condition.

Sharpening Tools (special accessories)

Chain pitch	Round file Ø	Round file	File holder	Filing gauge	Flat file	Sharpening kit ¹⁾
inch (mm)	mm (inch)	Part No.	Part No.	Part No.	Part No.	Part No.
1/4 P (6,35)	3,2 (1/8)	5605 771 3206	5605 750 4300	0000 893 4005	0814 252 3356	5605 007 1000
1/4 (6,35)	4,0 (5/32)	5605 772 4006	5605 750 4327	1110 893 4000	0814 252 3356	5605 007 1027
3/8 P (9,32)	4,0 (5/32)	5605 772 4006	5605 750 4327	1110 893 4000	0814 252 3356	5605 007 1027
0.325 (8,25)	4,8 (3/16)	5605 772 4806	5605 750 4328	1110 893 4000	0814 252 3356	5605 007 1028
3/8 (9,32)	5,2 (13/64)	5605 772 5206	5605 750 4329	1110 893 4000	0814 252 3356	5605 007 1029

¹⁾ consisting of file holder with round file, flat file and filing gauge

Inspections and Maintenance by Dealer

Bearings in Telescoping Drive Tube (depending on model)

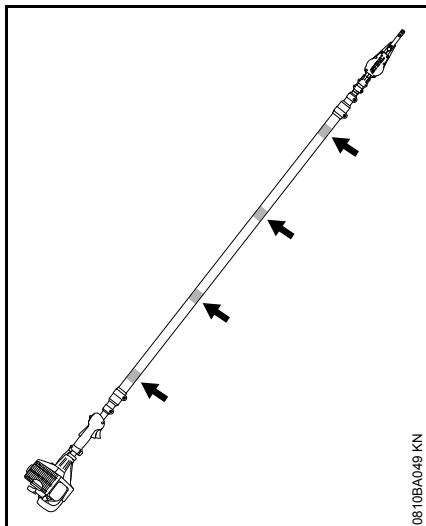

The bearings (arrows) in the telescoping drive tube are subject to normal wear and tear.

If there a noticeable increase in vibrations or running noises:

- Have your dealer check and, if necessary, replace the bearings in

the drive tube – STIHL recommends a STIHL servicing dealer.

Maintenance and Care

The following intervals apply to normal operating conditions only. If your daily working time is longer or operating conditions are difficult (very dusty work area, etc.), shorten the specified intervals accordingly.		before starting work	after finishing work or daily	after each refueling stop	weekly	monthly	every 12 months	if problem	if damaged	as required
Complete machine	Visual inspection (condition, leaks)	X		X						
	Clean		X							
Control handle	Check operation	X		X						
Air filter	Clean							X		X
	Replace								X	
Manual fuel pump (if fitted)	Check	X								
	Have repaired by servicing dealer ¹⁾								X	
Pickup body in fuel tank	Have checked by servicing dealer ¹⁾							X		
	Have replaced by servicing dealer ¹⁾						X		X	X
Fuel tank	Clean							X		X
Carburetor	Check idle adjustment – chain must not rotate	X		X						
	Adjust idle speed									X
Spark plug	Readjust electrode gap							X		
	Replace after every 100 operating hours									
Cooling inlets	Visual inspection		X							
	Clean									X
Valve clearance ¹⁾	Check and, if necessary, have adjusted by dealer after first 139 hours of operation									X
Combustion chamber ¹⁾	Decoke after first 139 hours of operation, then every 150 hours of operation									X
Spark arresting screen ²⁾ in muffler	Check		X					X		
	Clean or replace								X	X
All accessible screws and nuts (not adjusting screws)	Retighten									X

The following intervals apply to normal operating conditions only. If your daily working time is longer or operating conditions are difficult (very dusty work area, etc.), shorten the specified intervals accordingly.		before starting work	after finishing work or daily	after each refueling stop	weekly	monthly	every 12 months	if problem	if damaged	as required
Antivibration elements	Check	X						X		X
	Have replaced by servicing dealer ¹⁾								X	
Chain lubrication	Check	X								
Chain	Inspect, also check sharpness	X		X						
	Check chain tension	X		X						
	Sharpen									X
Guide bar	Check (wear, damage)	X								
	Clean and turn over				X			X		
	Deburr				X					
	Replace								X	X
Chain sprocket	Check				X					
	Have replaced by servicing dealer ¹⁾									X
Safety labels	Replace								X	

¹⁾ STIHL recommends an authorized STIHL servicing dealer.

²⁾ not in all versions, market-specific

Minimize Wear and Avoid Damage

Observing the instructions in this manual helps reduce the risk of unnecessary wear and damage to the power tool.

The power tool must be operated, maintained and stored with the due care and attention described in this owner's manual.

The user is responsible for all damage caused by non-observance of the safety precautions, operating and maintenance instructions in this manual. This includes in particular:

- Alterations or modifications to the product not approved by STIHL.
- Using tools or accessories which are neither approved or suitable for the product or are of a poor quality.
- Using the product for purposes for which it was not designed.
- Using the product for sports or competitive events.
- Consequential damage caused by continuing to use the product with defective components.

Maintenance Work

All the operations described in the "Maintenance Chart" must be performed on a regular basis. If these maintenance operations cannot be performed by the owner, they should be performed by a servicing dealer.

STIHL recommends that you have servicing and repair work carried out exclusively by an authorized STIHL

servicing dealer. STIHL dealers are regularly given the opportunity to attend training courses and are supplied with the necessary technical information.

If these maintenance operations are not carried out as specified, the user assumes responsibility for any damage that may occur. Among other parts, this includes:

- Damage to the engine due to neglect or deficient maintenance (e.g. air and fuel filters), incorrect carburetor adjustment or inadequate cleaning of cooling air inlets (intake ports, cylinder fins).
- Corrosion and other consequential damage resulting from improper storage.
- Damage to the machine resulting from the use of poor quality replacement parts.

Parts Subject to Wear and Tear

Some parts of the power tool are subject to normal wear and tear even during regular operation in accordance with instructions and, depending on the type and duration of use, have to be replaced in good time. Among other parts, this includes:

- Saw chain, guide bar
- Drive components (clutch, clutch drum, chain sprocket)
- Filters (air, oil, fuel)
- Starter mechanism
- Spark plug
- Components of antivibration system

Main Parts

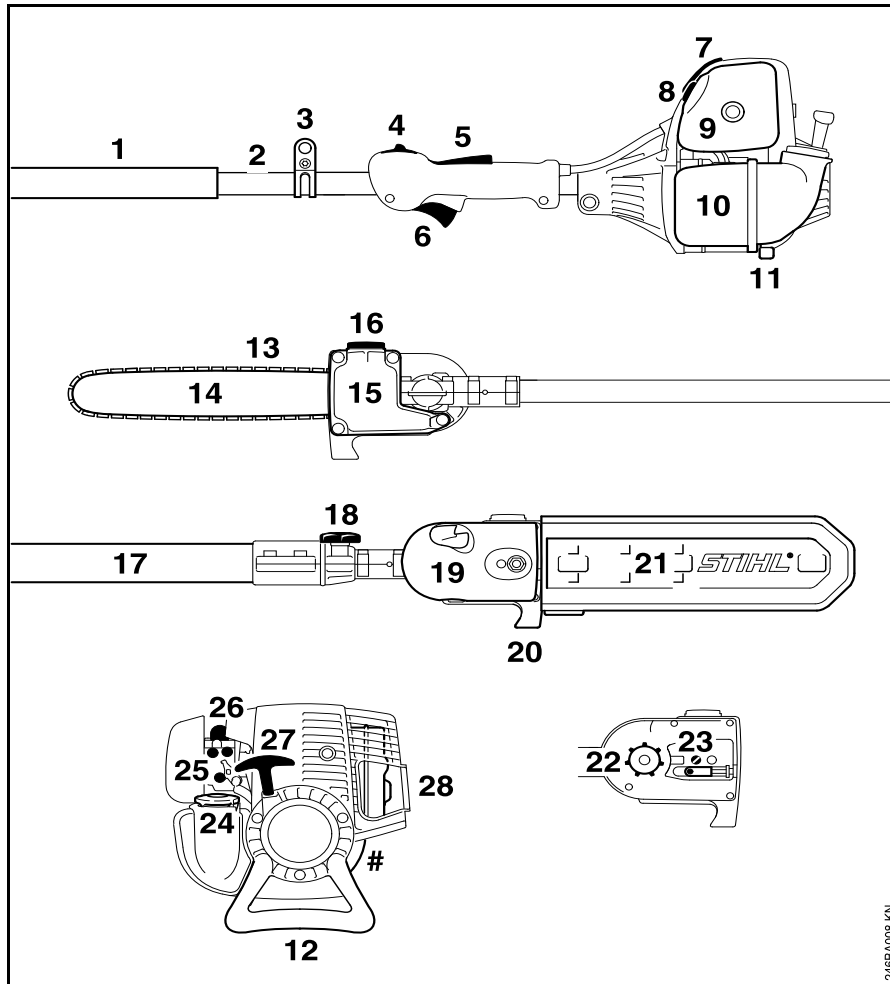

- 1 Handle hose (HT 100, HT 130)
 - 2 Rigid shaft (HT 100, HT 130)
 - 3 Carrying ring
 - 4 Slide control
 - 5 Throttle trigger lockout
 - 6 Throttle trigger
 - 7 Spark plug boot
 - 8 Choke knob
 - 9 Air filter cover
 - 10 Fuel tank
 - 11 Machine support
 - 12 Machine support (HT 130, HT 131)
 - 13 Oilomatic chain
 - 14 Guide bar
 - 15 Oil tank
 - 16 Oil filler cap
 - 17 Telescoping shaft (HT 101, HT 131)
 - 18 Clamp screw (HT 101, HT 131)
 - 19 Chain sprocket cover
 - 20 Hook
 - 21 Chain scabbard
 - 22 Chain sprocket
 - 23 Chain tensioner
 - 24 Tank cap
 - 25 Carburetor adjusting screws
 - 26 Manual fuel pump
 - 27 Starter grip
 - 28 Muffler (some versions with spark arresting screen)
- # Serial number

2465A008 KN

Specifications

Engine

STIHL single cylinder four-stroke engine with mixture lubrication

HT 100, HT 101

Displacement:	31.4 cc
Bore:	40 mm
Stroke:	25 mm
Engine power to ISO 8893:	1.05 kW (1.4 bhp) at 7,000 rpm
Idle speed:	2,800 rpm
Cut-off speed (rated):	10,200 rpm
Max. output shaft speed (chain sprocket):	8,290 rpm
Valve clearance	
Inlet valve:	0.10 mm
Exhaust valve:	0.10 mm

HT 130, HT 131

Displacement:	36.3 cc
Bore:	43 mm
Stroke:	25 mm
Engine power to ISO 8893:	1.4 kW (1.9 bhp) at 8,500 rpm
Idle speed:	2,800 rpm
Cut-off speed (rated):	10,200 rpm
Max. output shaft speed (chain sprocket):	10,500 rpm

Valve clearance	
Inlet valve:	0.10 mm
Exhaust valve:	0.10 mm

Ignition System

Electronic magneto ignition	
Spark plug (resistor type):	
HT 100, HT 101:	Bosch USR 7 AC
HT 130, HT 131:	NGK CMR 6 H
Electrode gap:	0.5 mm

Fuel System

All position diaphragm carburetor with integral fuel pump	
Fuel tank capacity:	530 cc (0.53 l)

Chain Lubrication

Fully automatic, speed-controlled oil pump with rotary piston	
Oil tank capacity:	220 cc (0.22 l)

Weight

dry, without bar and chain	
HT 100:	5.5 kg
HT 101:	7.6 kg
HT 130:	5.7 kg
HT 131:	7.8 kg

Cutting Attachment

Actual cutting length may be less than the specified length

Rollomatic E Mini guide bar

Cutting length:	30 cm
Pitch:	3/8" P (9.32 mm)
Groove width:	1.1 mm

Rollomatic E Mini Light guide bars

Cutting length:	25, 30 cm
Pitch:	3/8" P (9.32 mm)
Groove width:	1.1 mm

3/8" P chains

Picco Micro Mini 3 (61 PMM3) Type 3610	
Pitch:	3/8" P (9.32 mm)
Drive link gauge:	1.1 mm

Chain sprocket

6-tooth for 3/8" P
7-tooth for 3/8" P

Noise and Vibration Data

Noise and vibration data measurements include idling and rated maximum speed with the same duration of exposure.

For further details on compliance with Vibration Directive 2002/44/EC see www.stihl.com/vib/

Sound pressure level L_{peq} to ISO 11201

HT 100:	89 dB(A)
HT 101:	89 dB(A)
HT 130:	92 dB(A)
HT 131:	93 dB(A)

Sound power level L_{weq} to ISO 3744

HT 100:	101 dB(A)
HT 101:	101 dB(A)
HT 130:	106 dB(A)
HT 131:	106 dB(A)

Vibration measurement $a_{hv,eq}$ to EN ISO 11680-1

HT 100, HT 130

Shaft:

HT 100	4.0 m/s ²
HT 130	4.3 m/s ²

Control handle:

HT 100	4.7 m/s ²
HT 130	6.0 m/s ²

HT 101, HT 131

Shaft compressed:

HT 101	3.7 m/s ²
HT 131	3.0 m/s ²

Control handle:

HT 101	5.5 m/s ²
HT 131	4.7 m/s ²

Shaft fully extended:

HT 101	7.5 m/s ²
HT 131	3.4 m/s ²

Control handle:

HT 101	4.9 m/s ²
HT 131	4.7 m/s ²

The K-factor in accordance with Directive 2006/42/EC is 2.5 dB(A) for the sound pressure level and sound power level; the K-factor in accordance with Directive 2006/42/EC is 2.0 m/s² for the vibration measurement.

REACH

REACH is an EC regulation and stands for the Registration, Evaluation, Authorisation and Restriction of Chemical substances.

For information on compliance with the REACH regulation (EC) No. 1907/2006 see www.stihl.com/reach.

Maintenance and Repairs

Users of this machine may only carry out the maintenance and service work described in this user manual. All other repairs must be carried out by a servicing dealer.

STIHL recommends that you have servicing and repair work carried out exclusively by an authorized STIHL servicing dealer. STIHL dealers are regularly given the opportunity to attend training courses and are supplied with the necessary technical information.

When repairing the machine, only use replacement parts which have been approved by STIHL for this power tool or are technically identical. Only use high-quality replacement parts in order to avoid the risk of accidents and damage to the machine.

STIHL recommends the use of original STIHL replacement parts.

Original STIHL parts can be identified by the STIHL part number, the **STIHL** logo and the STIHL parts symbol  (the symbol may appear alone on small parts).

Disposal

Observe all country-specific waste disposal rules and regulations.

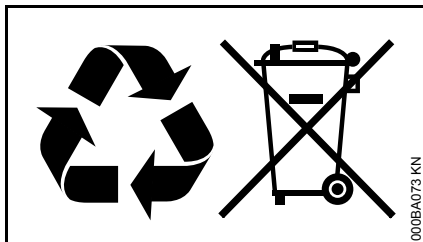

STIHL products must not be thrown in the garbage can. Take the product, accessories and packaging to an approved disposal site for environment-friendly recycling.

Contact your STIHL servicing dealer for the latest information on waste disposal.

EC Declaration of Conformity

ANDREAS STIHL AG & Co. KG
Badstr. 115
D-71336 Waiblingen

Germany

confirms that the product described below

Category:	Pole pruners
Make:	STIHL
Model:	HT 100 HT 101 HT 130 HT 131

Serial identification: 4182

Displacement

HT 100:	31.4 cc
HT 101:	31.4 cc
HT 130:	36.3 cc
HT 131:	36.3 cc

conforms to the provisions of Directives 2006/42/EC and 2004/108/EC (up to 19.04.2016), 2014/30/EU (from 20.04.2016) and has been developed and manufactured in compliance with the following standards in the versions valid on the date of production:

EN ISO 11680-1, EN 55012,
EN 61000-6-1

The EC type examination was carried out

TÜV Süd Product Service GmbH
(NB 0123)
Ridlerstrasse 65
D-80339 Munich

Certification No.

HT 100:	M6A 12 09 10127 385
HT 101:	M6A 13 03 10127 374
HT 130:	M6A 12 09 10127 373
HT 131:	M6A 13 08 10127 395

Technical documents deposited at:

ANDREAS STIHL AG & Co. KG
Produktzulassung (Product Licensing)

The year of manufacture and serial number are applied to the product.

Done at Waiblingen, 16.03.2016

ANDREAS STIHL AG & Co. KG

Thomas Elsner

Director Product Management and Services

0458-246-0121-E

englisch



www.stihl.com



0458-246-0121-E