

STIHL®

STIHL MS 170, 180

Instruction Manual



Contents

Guide to Using this Manual	2	Checking and Replacing the Chain Sprocket	31
Safety Precautions and Working Techniques	2	Maintaining and Sharpening the Saw Chain	32
Cutting Attachment	14	Maintenance and Care	35
Mounting the Bar and Chain (front chain tensioner)	14	Minimize Wear and Avoid Damage	37
Mounting the Bar and Chain (quick chain tensioner)	15	Main Parts	38
Tensioning the Saw Chain (front chain tensioner)	17	Specifications	39
Tensioning the Saw Chain (quick chain tensioner)	17	Special Accessories	40
Checking Chain Tension	18	Ordering Spare Parts	41
Fuel	18	Maintenance and Repairs	41
Fueling	19	EC Declaration of Conformity	42
Chain Lubricant	20	Quality Certification	43
Filling Chain Oil Tank	20		
Checking Chain Lubrication	21		
Chain Brake	21		
Information Before You Start	22		
Starting / Stopping the Engine	23		
Operating Instructions	26		
Taking Care of the Guide Bar	27		
Shroud	27		
Cleaning the Air Filter	28		
Adjusting the Carburetor	28		
Spark Arresting Screen in Muffler	29		
Catalytic Converter	29		
Spark Plug	29		
Starter rope	30		
Storing the Machine	31		

Dear Customer,

Thank you for choosing a quality engineered STIHL product.

This machine has been built using modern production techniques and comprehensive quality assurance. Every effort has been made to ensure your satisfaction and troublefree use of the machine.

Please contact your dealer or our sales company if you have any queries concerning your machine.

Your



Hans Peter Stihl



STIHL®

MS 170, MS 170 C, MS 180, MS 180 C

Guide to Using this Manual

Pictograms

Pictograms that appear on the machine are explained in this Instruction Manual.

Depending on the machine and equipment version, the following pictograms may appear on the machine.



Fuel tank; fuel mixture of gasoline and engine oil



Tank for chain oil; chain oil



Engage and release chain brake



Coasting brake



Direction of chain travel



Ematic; chain oil flow adjustment



Tension saw chain



Intake air baffle: winter operation



Intake air baffle: summer operation



Handle heating

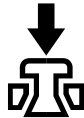

Actuate decompression valve

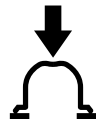

Actuate manual fuel pump

Symbols in text



Warning where there is a risk of an accident or personal injury or serious damage to property.



Caution where there is a risk of damaging the machine or its individual components.

Engineering improvements

STIHL's philosophy is to continually improve all of its products. For this reason we may modify the design, engineering and appearance of our products periodically.

Therefore, some changes, modifications and improvements may not be covered in this manual.

Safety Precautions and Working Techniques



Because a chain saw is a high-speed wood-cutting tool with very sharp cutters, some special safety precautions must be observed in addition to those that generally apply when working with an axe or hand saw.



It is important you read and understand the instruction manual before using your power tool for the first time and keep the manual in a safe place for future reference. Non-observance of the safety precautions may result in serious or even fatal injury.

Observe all applicable local safety regulations, standards and ordinances.

If you have not used this type of power tool before: Have your dealer or other experienced user show you how to operate your power tool or attend a special course in its operation.

Minors should never be allowed to use a power tool.

Keep bystanders, especially children, and animals away from the work area.

When the power tool is not in use, shut it off so that it does not endanger others. Secure it against unauthorized use.

The user is responsible for avoiding injury to third parties or damage to their property.

Do not lend or rent your power tool without the instruction manual. Be sure that anyone using it understands the information contained in this manual.

The use of noise emitting power tools may be restricted to certain times by national or local regulations.

To operate the power tool you must be rested, in good physical condition and mental health. If you have any condition that might be aggravated by strenuous work, check with your doctor before operating a power tool.

Persons with pacemakers only: The ignition system of your power tool produces an electromagnetic field of a very low intensity. This field may interfere with some pacemakers. To reduce health risks, STIHL recommends that persons with pacemakers consult their physician and the pacemaker manufacturer before operating this tool.

Do not operate the power tool if you are under the influence of any substance (drugs, alcohol) which might impair vision, dexterity or judgment.

To reduce the risk of accidents or injury, put off the work in poor weather conditions (rain, snow, ice, wind).

Use your saw for cutting wood or wooden objects only.

Do not use your power tool for any other purpose since **this may result in accidents**.

Only use tools, guide bars, chains, chain sprockets and accessories that are explicitly approved for this power tool model by STIHL or are technically identical. If you have any questions in this respect, consult a servicing dealer.

Use only high quality parts and accessories in order to avoid the risk of accidents and damage to the machine.

STIHL recommends the use of STIHL original tools, guide bars, chains, chain sprockets and accessories. They are specifically designed to match your model and meet your performance requirements.

Never attempt to modify your power tool in any way since this may increase the risk of personal injury. STIHL excludes all liability for personal injury and damage to property caused while using unauthorized attachments.

Do not use a pressure washer to clean the unit. The solid jet of water may damage parts of the unit.

Clothing and Equipment

Wear proper protective clothing and equipment.



Clothing must be sturdy but allow complete freedom of movement. Wear snug-fitting clothing with **cut retardant inserts** – an overall and jacket combination, do not wear a work coat.

Avoid clothing that could get caught on branches or brush or moving parts of the machine. Do not wear a scarf, necktie or jewelry. Tie up and confine long hair (e.g. with a hair net, cap, hard hat, etc.).



Wear steel-toed **safety boots** with cut retardant inserts and non-slip soles.



Wear a **safety hard hat** where there is a danger of head injuries from falling objects.

Wear **safety glasses** or a **face shield** and **hearing protection** e.g. earplugs or ear muffs.



Wear **heavy-duty gloves**.

STIHL offers a comprehensive range of personal protective clothing and equipment.

Transporting the Chain Saw

Always engage the chain brake and fit the chain guard (scabbard) before carrying the saw short distances. Also stop the engine before carrying the saw longer distances (more than about 50 m).

Always carry the saw by the front handle (handlebar) – with the hot muffler away from your body – the guide bar must point to the rear. To **avoid serious burn injuries**, avoid touching hot parts of the machine, especially the surface of the muffler.

Transporting in a vehicle: Properly secure your power tool to prevent turnover, fuel spillage and damage.

Fueling



Gasoline is an extremely flammable fuel. Keep clear of naked flames. Do not spill any fuel – do not smoke.

Always shut off the engine before refueling.

Do not fuel a hot engine – **fuel may spill and cause a fire.**

Open the fuel cap carefully to allow any pressure build-up in the tank to release slowly and avoid fuel spillage.

Fuel your power tool only in well-ventilated areas. If you spill fuel, wipe the machine immediately – if fuel gets on your clothing, change immediately.

Your power tool comes standard with either a screw-type or bayonet-type fuel cap.



After fueling, tighten down the screw-type fuel cap as securely as possible.



Insert the fuel cap with hinged grip (bayonet-type cap) correctly in the opening, turn it clockwise as far as stop and fold the grip down.

This reduces the risk of unit vibrations causing the fuel cap to loosen or come off and spill quantities of fuel.

Before starting

Check that your power tool is properly assembled and in good condition – refer to appropriate chapters in the instruction manual.

- Check operation of chain brake, front hand guard
- Correctly mounted guide bar
- Correctly tensioned chain
- Smooth action of throttle trigger and throttle trigger interlock – throttle trigger must return automatically to idle position.
- Master Control lever / stop switch must move easily to **STOP** or **0**
- Check that the spark plug boot is secure – a loose boot may cause arcing that could ignite combustible fumes **and cause a fire.**
- Never attempt to modify the controls or the safety devices in any way.
- Keep the handles dry and clean – free from oil and pitch – for safe control of the chain saw.

To reduce the risk of personal injury, do not operate your saw if it is damaged or not properly assembled.

Starting the engine

Start the engine at least 3 meters from the fueling spot, outdoors only.

Place the unit on firm ground in an open area. Make sure you have good balance and secure footing. Hold the unit securely. The cutting attachment must

be clear of the ground and all other obstructions because it may begin to run when the engine starts.

Your chain saw is designed to be operated by one person only. Do not allow other persons in the work area – even when starting.

To reduce risk of chain rotation and personal injury, lock the chain with the chain brake before starting.

Do not drop start your machine – the correct starting procedure is described in the instruction manual.

Do not attempt to start the saw when the saw chain is in a cut.

Holding and Controlling the Power Tool

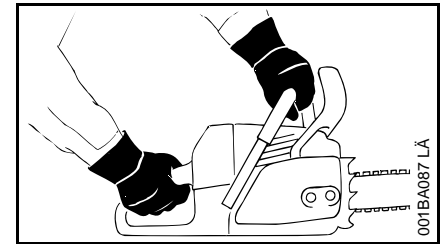

Always **hold your saw firmly with both hands:** Right hand on the rear handle, even if you are left-handed. To ensure safe control, wrap your fingers tightly around the front and rear handles.

During Operation

Make sure you always have good balance and secure footing.

In the event of impending danger or in an emergency, switch off the engine immediately by moving the Master Control lever / stop switch to **STOP** or **0**.

Your power tool is designed to be operated by one person only. Do not allow other persons in the work area.

Never leave a running machine unattended.

When the engine is running: Note that the chain continues to rotate for a short period after you let go of the throttle trigger (flywheel effect).

Take special care in slippery conditions – damp, snow, ice, on slopes, uneven ground and freshly debarked logs.

Watch out for obstacles such as tree stumps, roots and ditches which could cause you to trip or stumble.

Do not work alone – keep within calling distance of others in case help is needed.

Be particularly alert and cautious when wearing hearing protection because your ability to hear warnings (shouts, alarms, etc.) is restricted.

To reduce the risk of accidents, take a break in good time to avoid tiredness or exhaustion.

To reduce risk of fire, keep hot exhaust gases and hot muffler away from easily combustible materials (e.g. wood chips, bark, dry grass, fuel). Mufflers with a catalytic converter can become particularly hot.



Your power tool produces toxic exhaust fumes as soon as the engine is running. These fumes may be colorless and odorless and contain unburned hydrocarbons and benzol. Never run the engine indoors or in poorly ventilated locations, even if your model is equipped with a catalytic converter.

To reduce the risk of serious or fatal injury from breathing toxic fumes, ensure proper ventilation when working in trenches, hollows or other confined locations.

To reduce the risk of accidents, stop work immediately in the event of nausea, headache, visual disturbances (e.g. reduced field of vision), problems with hearing, dizziness, deterioration in ability to concentrate. Apart from other possibilities, these symptoms may be caused by an excessively high concentration of exhaust gases in the work area.

The dusts (e.g. sawdust), vapor and smoke produced during operation may be dangerous to health. If dust levels are very high, wear a suitable respirator.

Check the saw chain at regular short intervals during operation or immediately if there is a noticeable change in cutting behavior:

- Shut off the engine and wait until the chain comes to a complete standstill.
- Check condition
- Check sharpness.

Do not touch the chain while the engine is running. If the chain becomes jammed by an obstruction, switch off the engine immediately before attempting to remove the obstruction.

To reduce the risk of injury, shut off the engine before changing the saw chain.

To reduce the risk of fire, do not smoke while operating or standing near your power tool. Note that combustible fuel vapor may escape from the fuel system.

If your power tool is subjected to unusually high loads for which it was not designed (e.g. heavy impact or a fall), always check that it is in good condition before continuing work – see also "Before Starting". Check the fuel system in particular for leaks and make sure the safety devices are working properly. Do not continue operating your power tool if it is damaged. In case of doubt, have the machine checked by your servicing dealer.

Make sure the idle speed setting is correct. The chain must not run when the engine is idling with the throttle trigger released. Check and correct the idle speed setting at regular intervals. If the saw chain still moves, have your dealer check your machine and make proper adjustments or repairs.

Reactive Forces

The most common reactive forces that occur during cutting are: kickback, pushback and pull-in.

Dangers of kickback



Kickback can result in serious or fatal injury.

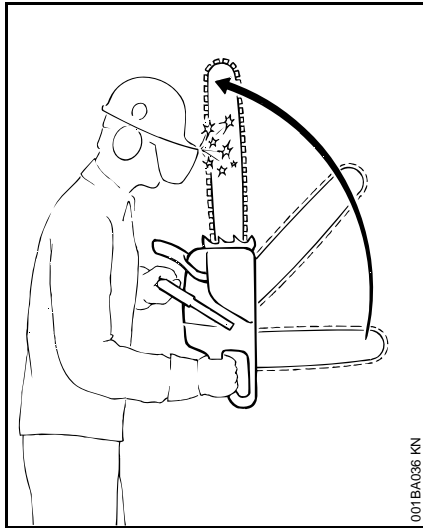

Kickback occurs when the saw is suddenly thrown up and back in an uncontrolled arc towards the operator.

Kickback occurs, e.g.

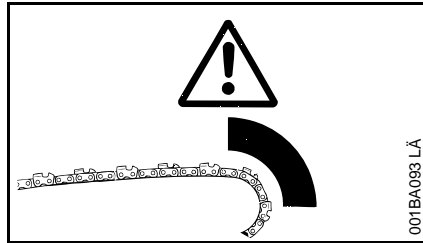

- when the upper quadrant of the bar nose unintentionally contacts wood or another solid object, e.g. when another limb is touched accidentally during limbing.
- when the chain at the nose of the guide bar is pinched in the cut.

Quickstop chain brake:

This device reduces the risk of injury in certain situations – it cannot prevent kickback. If activated, the brake stops the saw chain within a fraction of a second – for a description of this device refer to chapter on "Chain Brake" in this manual.

To reduce the risk of kickback

- Work cautiously and avoid situations which could cause kickback.
- Hold the saw firmly with both hands and maintain a secure grip.
- Always cut at full throttle.
- Be aware of the location of the guide bar nose at all times.
- Do not cut with the bar nose.
- Take special care with small, tough limbs, they may catch the chain.

- Never cut several limbs at once.
- Do not overreach.
- Never cut above shoulder height.
- Use extreme caution when re-entering a previous cut.
- Do not attempt plunge cuts if you are not experienced in this cutting technique.
- Be alert for shifting of the log or other forces that may cause the cut to close and pinch the chain.
- Always cut with a correctly sharpened, properly tensioned chain – the depth gauge setting must not be too large.
- Use a low kickback chain and a narrow radius guide bar.

Pull-in (A)

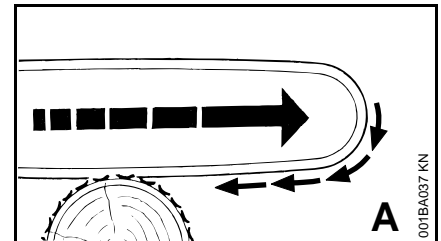

Pull-in occurs when the chain on the bottom of the bar is suddenly pinched, caught or encounters a foreign object in the wood. The reaction of the chain pulls the saw forward – **always hold the spiked bumper securely against the tree or limb.**

Pushback (B)

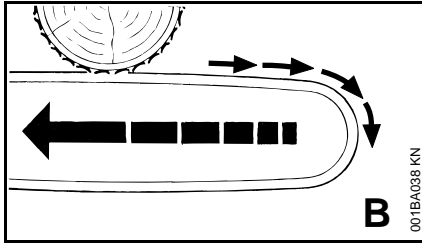

Pushback occurs when the chain on the top of the bar is suddenly pinched, caught or encounters a foreign object in the wood. The reaction of the chain drives the saw straight back toward the operator. **To avoid pushback.**

- Be alert to situations that may cause the top of the guide bar to be pinched
- Do not twist the guide bar in the cut.

Exercise extreme caution

- with leaners
- with trees that have fallen unfavorably between other trees and are under strain
- when working in blowdown areas.

Do not work with the chainsaw in such circumstances. Use block and tackle, cable winch or tractor.

Pull out exposed and cleared logs. Select clear area for cutting.

Deadwood (dry, decayed or rotted wood) represents a considerable risk that is difficult to assess. Identifying the extent of the dangers is complicated, if not impossible. Use aids such as a cable winch or tractor in such cases.

When felling in the vicinity of roads, railways, power lines, etc., take extra precautions. If necessary, inform the police, utility company or railway authority.

Cutting

Do not operate your saw with the starting throttle lock engaged. Engine speed cannot be controlled with the throttle trigger in this position.

Work calmly and carefully – in daylight conditions and only when visibility is good. Ensure you do not endanger others – stay alert at all times.

Use the shortest possible guide bar: The chain, guide bar and chain sprocket must match each other and your saw.

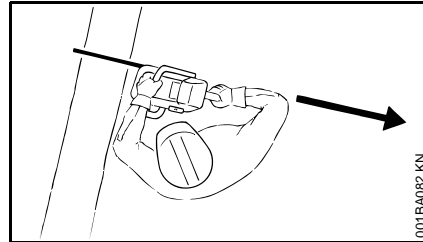

Position the saw so that your body is clear of the cutting attachment.

Always pull the saw out of the cut with the chain running.

Use your chain saw for cutting only. It is not designed for prying or shoveling away limbs, roots or other objects.

Do not underbuck freely hanging limbs.

To reduce the risk of injury, take special care when cutting shattered wood because of the risk of injury from splinters being caught and thrown in your direction.

Make sure your saw does not touch any foreign materials: Stones, nails, etc. may be flung off, damage the saw chain or cause the saw to kick back unexpectedly.



If on a slope, stand on the uphill side of the log. Watch out for rolling logs.

When working at heights:

- Always use a lift bucket
- Never work on a ladder or in a tree
- Never work on an insecure support
- Do not work above shoulder height
- Never operate your unit with one hand

Begin cutting with the saw at full throttle and engage the spiked bumper firmly in the wood, and then continue cutting.

Never work without the spiked bumper because the saw may pull you forwards and off balance. Always hold the spiked bumper securely against the tree or limb.

Note when reaching the end of a cut that the saw is no longer supported in the kerf. You have to take the full weight of the saw since **it might otherwise go out of control.**

Felling

Do not attempt felling unless you have been trained in the necessary techniques. **To reduce the risk of accidents and injury**, do not attempt felling or limbing if you are not an experienced chain saw user.

Observe all country-specific regulations on felling techniques.

Check that there are no other persons in the felling area – other than helpers.

Make sure no-one is endangered by the falling tree – the noise of your engine may drown any warning calls.

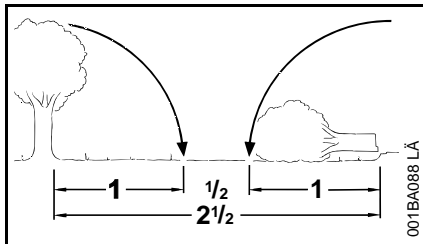

Maintain a distance of at least 2 1/2 tree lengths from the next felling site.

Determine direction of fall and escape paths

Select gap in stand into which you want the tree to fall.

Pay special attention to the following points:

- The natural lean of the tree
- Any unusually heavy limb structure, damage
- The wind direction and speed – do not fell in high winds
- Sloping ground
- Neighboring trees
- Snow load
- Soundness of tree – take special care if trunk is damaged or in case of deadwood (dry, decayed or rotted wood)

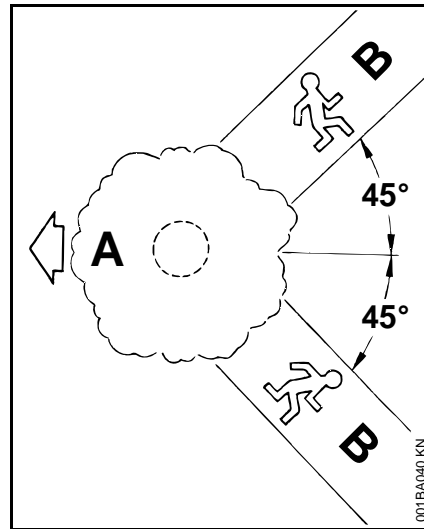

A Direction of fall

B Escape paths

- Establish paths of escape for everyone concerned – opposite to direction of fall at about 45°.
- Remove all obstacles from escape paths.
- Place all tools and equipment a safe distance away from the tree, but not on the escape paths.
- Always keep to the side of the falling tree and only walk away along the preplanned escape path.
- On steep slopes, plan escape routes parallel to the slope.
- When walking away along the escape path, watch out for falling limbs and watch the top of the tree.

Preparing work area at base of tree

- First clear the tree base and work area from interfering limbs and brush to provide a secure footing.
- Clean lower portion of tree base (e.g. with an axe) – sand, stones and other foreign objects will dull the saw chain.

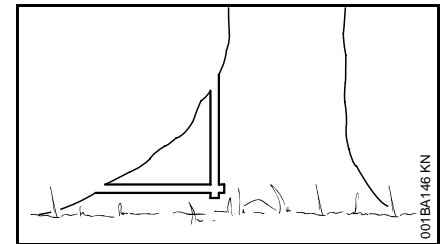

- Remove large buttress roots: Make the vertical cut first, then the horizontal – but only if the wood is sound

Felling notch

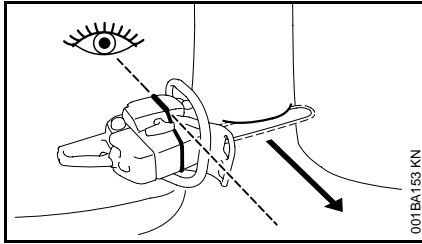

When making the felling notch, make use of the gunning sight on the shroud and fan housing to check the planned direction of fall.

Position your saw so that the gunning sight points in exactly the direction you want the tree to fall.

There are several approved methods for making the felling notch – observe country-specific regulations on felling techniques.

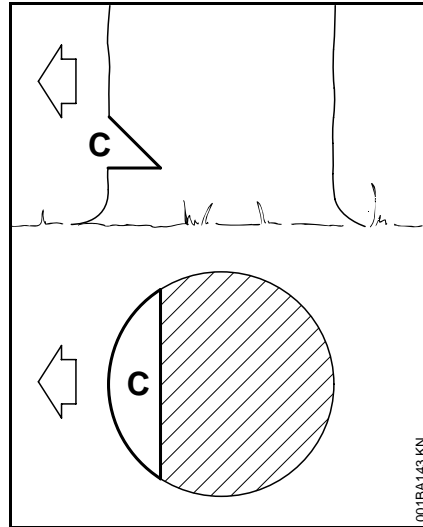

The felling notch (C) determines the direction of fall.

STIHL recommends the following method:

- Make the horizontal cut – check the direction of fall with the gunning sight.
- Make angle cut at about 45°.
- Check the felling notch and correct it if necessary.

Important:

- Felling notch at a right angle to the planned direction of fall.
- As close to the ground as possible.
- Cut to a depth of about 1/5 to 1/3 of the trunk diameter.

Sapwood cuts

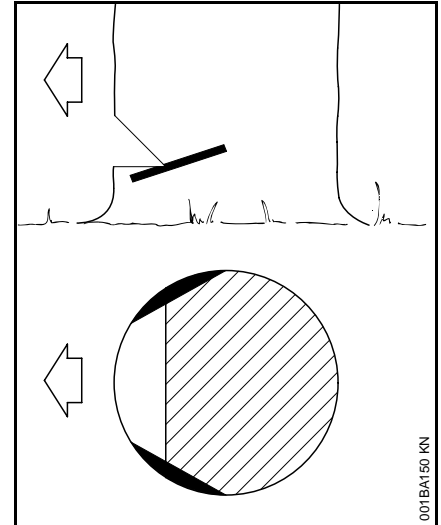

Sapwood cuts in long-fibered softwood help prevent sapwood splintering when the tree falls. Make cuts at both sides of the trunk at same height as bottom of felling notch to a depth of about 1/10 of trunk diameter. On large diameter trees, cut to no more than width of guide bar.

Do not make sapwood cuts if wood is diseased.

Felling

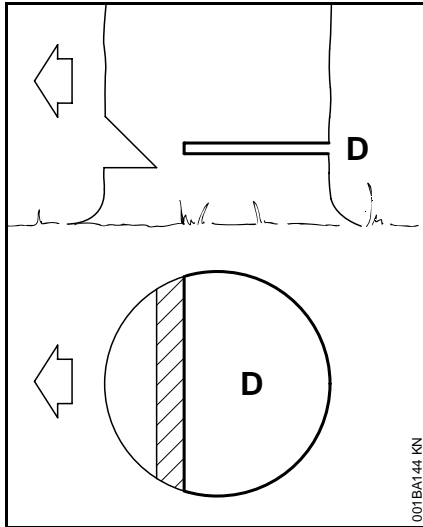

Shout a warning before starting the felling cut.

- Make the felling cut (D) slightly higher than bottom of the felling notch.
- Cut horizontally.
- Leave approx. 1/10 of the tree diameter uncut between the felling cut and the felling notch. This is the hinge.

Drive wedges into the felling cut in good time. Use only wooden, aluminum or plastic wedges. Never steel, which can damage the chain and cause kickback.

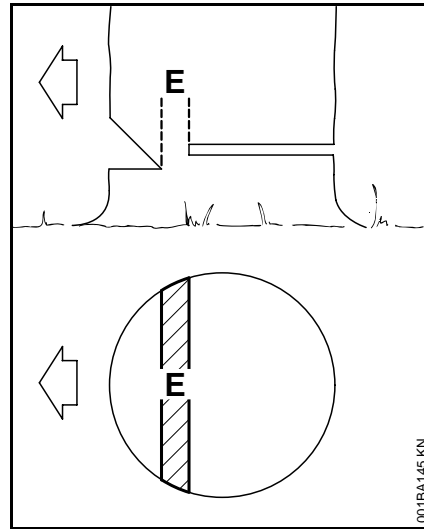

The **hinge** (E) helps control the falling tree.

- Do not cut through the hinge – you could lose control of the direction of fall – **this could result in an accident.**
- Leave a broader hinge on rotten trees.

Shout a second warning immediately before the tree falls.

Small diameter trees: Simple fan cut

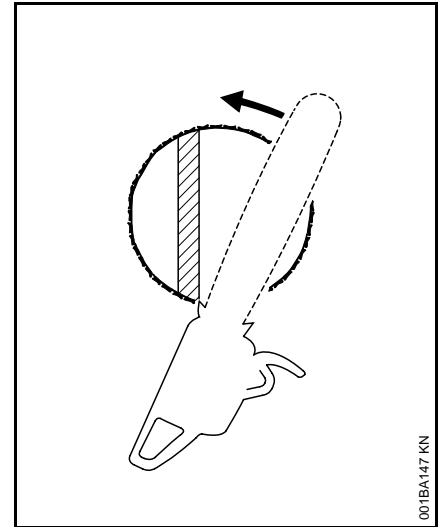

- Apply the spiked bumper behind the hinge – pivot the saw around this point – only as far as the hinge. The spiked bumper rolls against the trunk.

Large diameter trees: Sectioning method

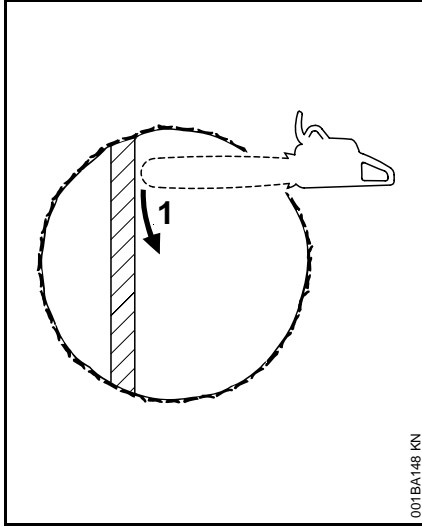

If the diameter of the tree is greater than the length of the guide bar, use the sectioning method.

1. First cut

Nose of guide bar should enter wood just behind the hinge – hold the saw horizontally and swing it as far as possible, using the bumper spike as a pivot – avoid repositioning the saw more than necessary.

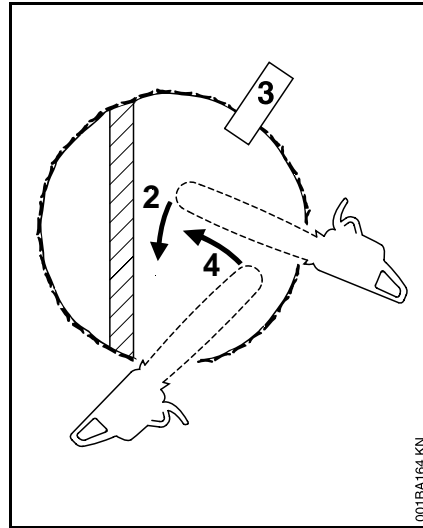

2. When repositioning the saw for the next cut, keep the guide bar fully engaged in the kerf to keep the felling cut straight – apply the spiked bumper again, and so on.
3. Insert a wedge (3) in the cut.
4. Last cut: Apply the spiked bumper as for the simple fan cut – do not cut through the hinge.

Special cutting techniques

Plunge cuts and heartwood cuts require special training and experience.

Plunge cutting

- For felling leaners
- For relieving cuts during bucking
- For DIY projects

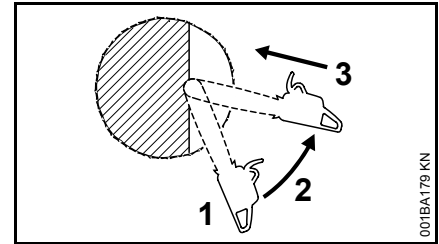

- Use a low kickback chain and exercise particular caution
1. Begin cut by applying the lower portion of the guide bar nose – do not use upper portion because of – **risk of kickback**. Cut until depth of kerf is twice the width of the guide bar.
 2. Swing saw slowly into plunge-cutting position – take care because of the **risk of kickback or pushback**.
 3. Make the plunge cut very carefully. **Danger of pushback.**

Heartwood cut

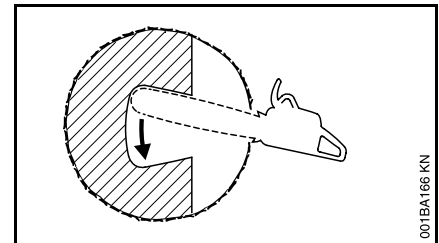

- If tree diameter is more than twice the length of the guide bar.
- If a large portion of heartwood remains uncut on large diameter trees.

- On trees that are difficult to fell (oak, beech), to prevent heartwood splintering and maintain planned direction of fall.
- On soft deciduous trees to relieve tension in lying log and prevent slivers in the center of the hinge being torn out of the log.
- Make the plunge cut in the center of the felling notch – **there is a danger of pushback at this point** – then swing the bar in the direction of the arrow.

Limbing

Do not attempt limbing unless you have been trained in the necessary techniques. **To reduce the risk of accidents and injury**, do not attempt felling or limbing if you are not an experienced chain saw user.

- Use a low kickback chain.
- Work with the saw supported wherever possible.
- Do not stand on the log while limbing it.
- Do not cut with the bar nose.
- Watch for limbs which are under tension.
- Never cut several limbs at once.

When cutting small logs

- Use a sturdy and stable support – sawhorse.
- Never hold the log with your leg or foot.
- Never allow another person to hold the log or help in any other way.

Lying or standing logs under tension

Always make cuts in the correct sequence (first at the compression side (1), then at the tension side (2), the saw may otherwise pinch or kick back – **risk of injury**).

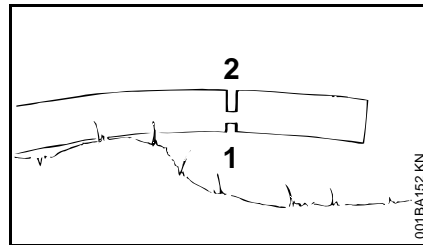
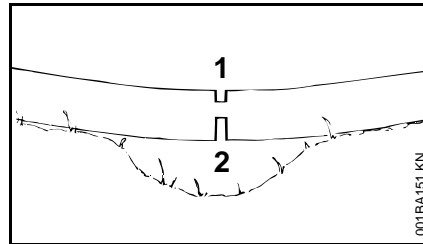

- Make relieving cut at the compression side (1)
- Make bucking cut at the tension side (2)

Be wary of **pushback** when making bucking cut from the bottom upwards (underbuck).

- ⚙ Do not cut a lying log at a point where it is touching the ground because the saw chain will otherwise be damaged.

Ripping cut

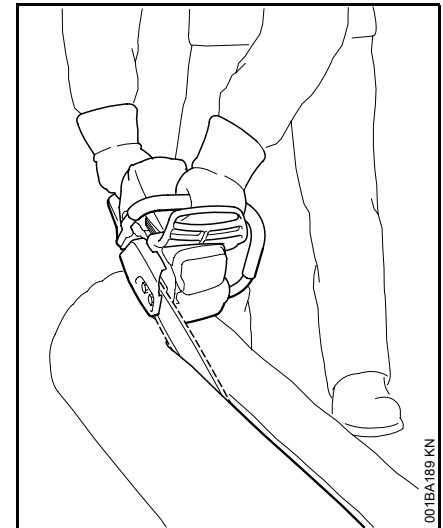

Cutting technique in which the bumper spike is not used – risk of pull-in – start the cut with the guide bar at the shallowest possible angle – take extra care since there is an increased **danger of kickback**.

Vibrations

Prolonged use of the power tool may result in vibration-induced circulation problems in the hands ("white finger disease").

No general recommendation can be given for the length of usage because it depends on several factors.

The period of usage is prolonged by:

- Hand protection (wearing warm gloves)
- Work breaks

The period of usage is shortened by:

- Any personal tendency to suffer from poor circulation (symptoms: frequently cold fingers, tingling sensation)
- Low outside temperatures
- Amount of gripping force (holding the power tool tightly restricts circulation)

Users who use the machine periodically or for long periods or users who repeatedly experience corresponding symptoms (e.g., tingling sensation in fingers), should undergo a medical examination.

Maintenance and Repairs

Service the machine regularly. Do not attempt any maintenance or repair work not described in the instruction manual. Have all other work performed by a servicing dealer.

STIHL recommends that you have servicing and repair work carried out exclusively by an authorized STIHL servicing dealer. STIHL dealers are regularly given the opportunity to attend training courses and are supplied with the necessary technical information.

Only use high-quality replacement parts in order to avoid the risk of accidents and damage to the machine. If you have any questions in this respect, consult a servicing dealer.

STIHL recommends the use of genuine STIHL replacement parts. They are specifically designed to match your model and meet your performance requirements.

To reduce the risk of injury, **always shut off the engine** before carrying out any maintenance or repairs or cleaning the machine. – Exception: Carburetor and idle speed adjustments.

Do not turn the engine over on the starter with the spark plug boot or spark plug removed unless the slide control / stop switch is on **STOP** or **0** since there is otherwise a **risk of fire** from uncontained sparking.

To reduce the **risk of fire**, do not service or store your machine near open flames.

Check the fuel filler cap for leaks at regular intervals.

Use only a spark plug of the type approved by STIHL and make sure it is in good condition – see "Specifications".

Inspect the ignition lead (insulation in good condition, secure connection).

Check the condition of the muffler.

To reduce the **risk of fire and damage to hearing**, do not operate your machine if the muffler is damaged or missing. –

Do not touch a hot muffler since **burn injury** will result.

Vibration behavior is influenced by the condition of the AV elements – check the AV elements at regular intervals.

Check the chain catcher and replace it if damaged.

Stopping the Engine

- before checking chain tension.
- before retensioning the chain.
- before replacing the chain.
- before rectifying problems.

Observe sharpening instructions – keep the chain and guide bar in good condition at all times for safe and correct handling of the saw. The chain must be properly sharpened, tensioned and well lubricated.

Always change the chain, guide bar and sprocket in good time.

Check condition of clutch drum periodically.

Store fuel and chain lubricant in properly labelled, safety-type canisters only. When handling gasoline, avoid direct contact with the skin and avoid inhaling fuel vapour – **health risk**.

To reduce the risk of injury, shut off the engine immediately if the chain brake malfunctions – contact your servicing dealer – do not use your power tool until the problem has been rectified (see "Chain Brake").

Cutting Attachment

STIHL is the only manufacturer in the industry to produce its own chain saws, guide bars, saw chains and chain sprockets.

A cutting attachment consists of the saw chain, guide bar and chain sprocket.

The cutting attachment that comes standard is designed to exactly match the chain saw.

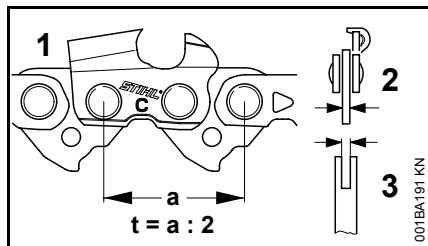

- The pitch (t) of the saw chain (1), chain sprocket and the nose sprocket of the Rollomatic guide bar must match.
- The drive link gauge (2) of the saw chain (1) must match the groove width of the guide bar (3).

If non-matching components are used, the cutting attachment may be damaged beyond repair after a short period of operation.

Mounting the Bar and Chain (front chain tensioner)

Removing the chain sprocket cover

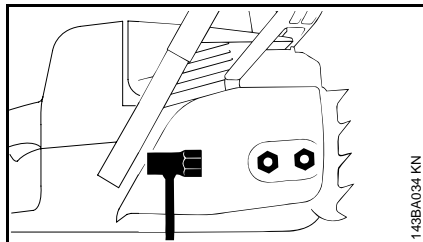

- Unscrew nut and remove chain sprocket cover

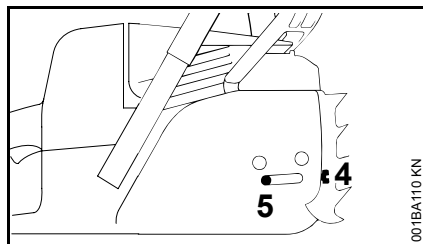

- Turn screw (4) to the left until the tensioner slide (5) butts against the left end of the housing slot

Releasing the chain brake

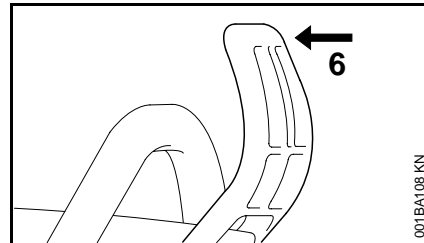

- Release the chain brake by pushing the hand guard (6) against the front handle

Fitting the saw chain

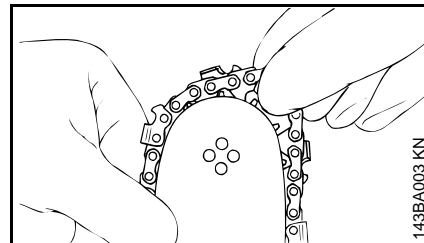

- ⚠ Put on protective gloves – risk of injury by the sharp cutters.
- Fit the chain starting at the nose of the guide bar

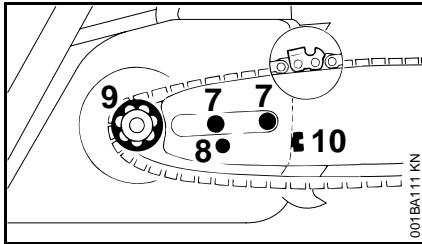

- Position the guide bar over the bolts (7) – the cutting edges of the saw chain must point to the right
- Position the locating hole (8) over the peg of the tensioner slide – simultaneously place the saw chain over the sprocket wheel (9)
- Turn screw (10) to the right until there is very little chain sag on the underside of the bar – and the drive link tangs engage in the bar groove
- Refit the chain sprocket cover – and then screw on the nut by hand until it is fingertight
- Next step: see "Tensioning the Saw Chain"

Mounting the Bar and Chain (quick chain tensioner)

Removing the chain sprocket cover

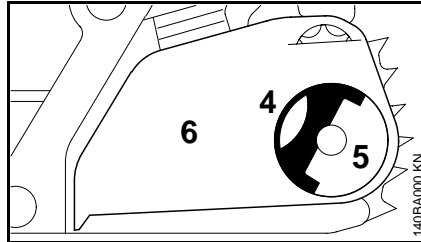

- Pull the hinged handle (4) out until it engages in the upright position.
- Turn the wingnut (5) counterclockwise until it hangs loose in the sprocket cover (6).
- Remove the sprocket cover.

Fitting the tensioning gear

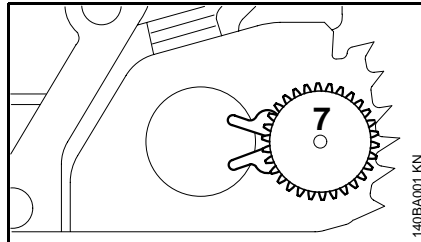

- Remove the tensioning gear (7) and turn it over.

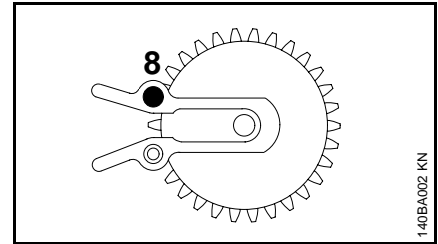

- Take out the screw (8).

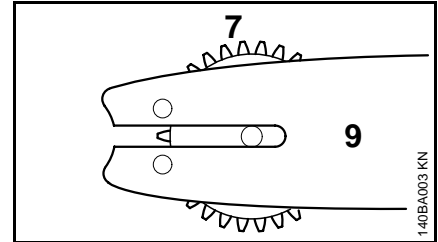

- Line up the tensioning gear (7) and guide bar (9).

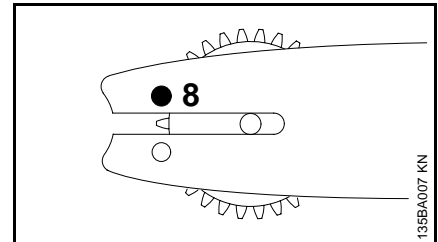

- Insert the screw (8) and tighten it down firmly.

Disengaging the chain brake

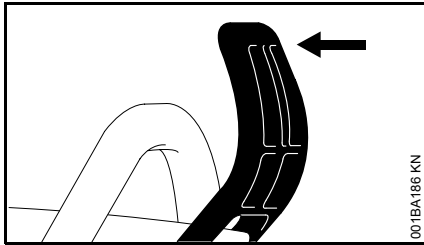

- Pull the hand guard towards the front handle until there is an audible click – the chain brake is disengaged.

Fitting the chain

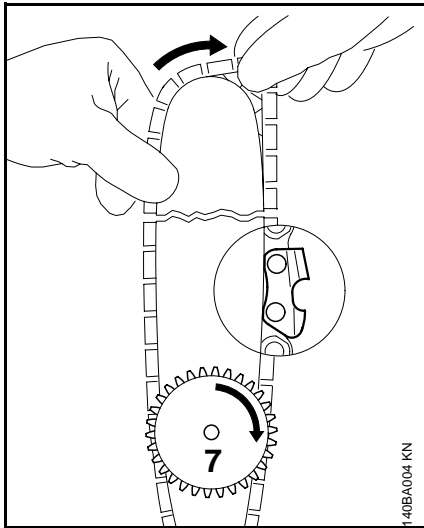

 Wear work gloves to protect your hands from the sharp cutters.

- Fit the chain – start at the bar nose. Pay attention to the position of the tensioning gear and the cutting edges.
- Turn the tensioning gear (7) clockwise as far as stop.
- Turn the guide bar so that the tensioning gear is facing you.

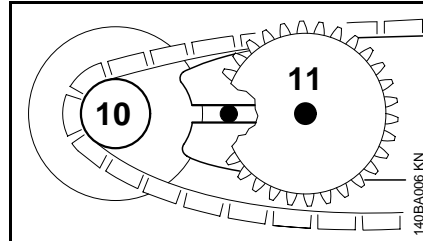

- Fit the chain over the sprocket (10).
- Push the guide bar over the bar stud (11), the head of the rear bar stud must engage the slot.

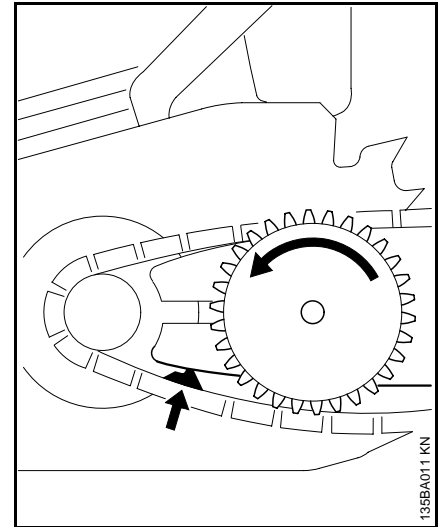

- Make sure the drive link tangs engage the bar groove (see arrow) and then rotate the tensioning gear counterclockwise as far as stop.

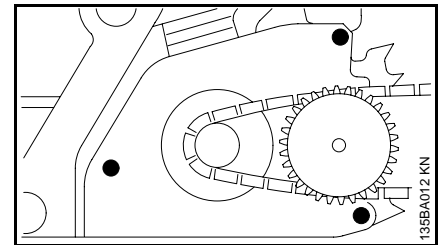

- Place the chain sprocket cover in position and engage the guide lugs in the recesses in the engine housing.

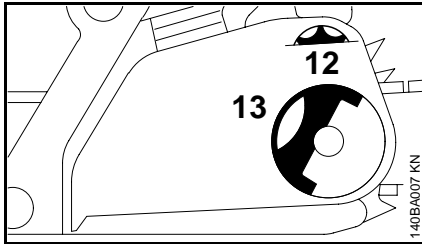

When fitting the chain sprocket cover, check that the teeth of the tensioning gear and adjusting wheel mesh properly.

- If necessary, turn the adjusting wheel (12) slightly until the sprocket cover can be pushed flush against the engine housing.
- Pull the hinged handle (13) out until it engages in the upright position.
- Engage wingnut and tighten it down moderately.
- Go to chapter on "Tensioning the Saw Chain"

Tensioning the Saw Chain (front chain tensioner)

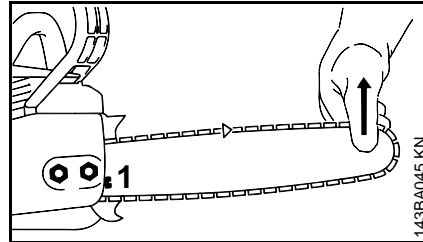

Retensioning during cutting work:

- Switch off the engine.
- Loosen the nuts.
- Hold the bar nose up.
- Use a screwdriver to turn the tensioning screw (1) clockwise until the chain fits snugly against the underside of the bar.
- While still holding the bar nose up, tighten down the nuts firmly.
- Go to "Checking Chain Tension".

A new chain has to be retensioned more often than one that has been in use for some time.

- Check chain tension frequently – see chapter on "Operating Instructions".

Tensioning the Saw Chain (quick chain tensioner)

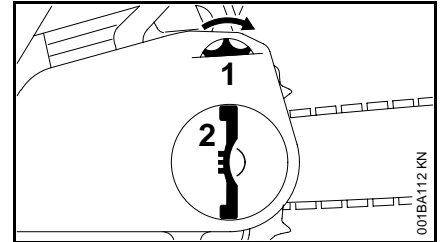

Retensioning during cutting work:

- Shut off the engine.
- Pull out the hinged clip and loosen the wingnut.
- Turn the adjusting wheel (1) clockwise as far as stop.
- Tighten down the wingnut (2) firmly by hand.
- Fold down the hinged clip.
- Go to "Tensioning the Saw Chain"

A new chain has to be retensioned more often than one that has been in use for some time.

- Check chain tension frequently – see chapter on "Operating Instructions".

Checking Chain Tension

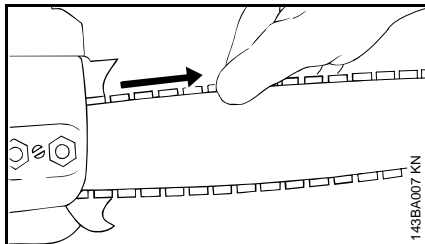

- Shut off the engine.
- Wear work gloves to protect your hands.
- The chain must fit snugly against the underside of the bar and it must still be possible to pull the chain along the bar by hand.
- If necessary, retension the chain.

A new chain has to be retensioned more often than one that has been in use for some time.

- Check chain tension frequently – see chapter on "Operating Instructions".

Fuel

Your engine requires a mixture of gasoline and engine oil.

 For health reasons, avoid direct skin contact with gasoline and avoid inhaling gasoline vapor.

STIHL MotoMix

STIHL recommends the use of STIHL MotoMix. This ready-to-use fuel mix contains no benzol or lead, has a high octane rating and ensures that you always use the right mix ratio.

STIHL MotoMix is specially formulated for use in STIHL engines and guarantees a long engine life.

MotoMix is not available in all markets.

Mixing Fuel

 Unsuitable fuels or lubricants or mix ratios other than those specified may result in serious damage to the engine. Poor quality gasoline or engine oil may damage the engine, sealing rings, hoses and the fuel tank.

Gasoline

Use only high-quality brand-name gasoline with a minimum octane rating of 90 – leaded or unleaded.

If your machine is equipped with a catalytic converter, you must use unleaded gasoline.

 A few tankfuls of leaded gasoline will greatly reduce the efficiency of the catalytic converter.

Engine Oil

Use only quality two-stroke engine oil. We recommend **STIHL two-stroke engine oil since it is specially formulated for use in STIHL engines and guarantees a long engine life.**

If STIHL two-stroke engine oil is not available, use only quality two-stroke oil designed for use in air-cooled engines. Do not use oils designed for water-cooled engines or engines with a separate lubricating system (e.g. conventional four-stroke engines).

Use only **STIHL 50:1 two-stroke engine oil** for the fuel mix in models with a catalytic converter.

Mix Ratio

STIHL 50:1 two-stroke engine oil: 50 parts gasoline to 1 part oil

Examples

Gasoline Liters	STIHL engine oil 50:1 Liters (ml)
1	0,02 (20)
5	0,10 (100)
10	0,20 (200)
15	0,30 (300)
20	0,40 (400)
25	0,50 (500)

 Other brand-name two-stroke engine oils: 25 parts gasoline to 1 part oil

- Use a canister approved for storing fuel. Pour oil into canister first, then add gasoline and mix thoroughly.

Storing Fuel

Store fuel only in approved safety-type fuel canisters in a dry, cool and safe location protected from light and the sun.

Fuel mix ages – only mix sufficient fuel for a few weeks work. Do not store fuel mix for longer than 3 months. Exposure to light, the sun, low or high temperatures can quickly make the fuel mix unusable.

- Thoroughly shake the mixture in the canister before fueling your machine.

! Pressure may build up in the canister – open it carefully.

- Clean the fuel tank and canister from time to time.

Dispose of remaining fuel and cleaning fluid properly in accordance with local regulations and environmental requirements.

Fueling



Preparing the machine

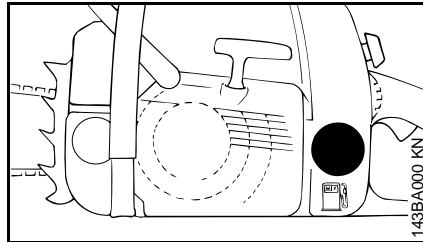

- Before fueling, clean the filler cap and the area around it so that dirt cannot fall into the tank.
- Always position the machine so that the filler cap is facing upwards
- Open the filler cap

Refueling

Take care not to spill fuel while fueling and do not overfill the tank.

STIHL recommends use of the STIHL filling system for fuel (special accessory).

! After fueling, tighten down the filler cap by hand as securely as possible.

Use a suitable tool (e. g., screwdriver or the combination wrench) for slotted filler caps.

Fuel pick-up body replacement

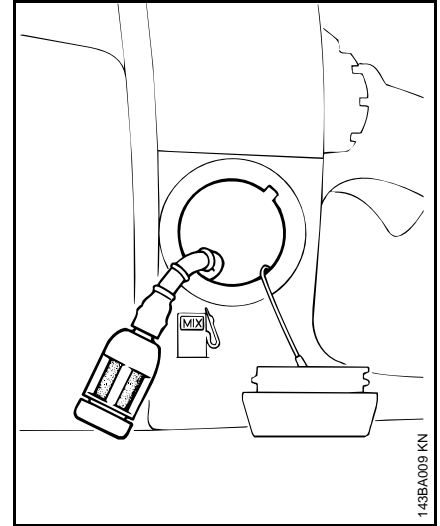

Change the fuel pick-up body every year; to do this:

- Drain the fuel tank
- Pull the fuel pick-up body out of the tank with a hook and disconnect it from the hose
- Connect a new fuel pick-up body to the hose
- Return the fuel pick-up body to the tank

Chain Lubricant

For automatic and reliable lubrication of the chain and guide bar – use only an environmentally compatible quality chain and bar lubricant. Rapidly biodegradable STIHL Bioplus is recommended.

 Biological chain oil must be resistant to aging (e.g. STIHL Bioplus) since it will otherwise quickly turn to resin. This results in hard deposits that are difficult to remove, especially in the area of the chain drive, clutch and chain. It may even cause the oil pump to seize.

The service life of the chain and guide bar depends on the quality of the lubricant. It is therefore essential to use only a specially formulated chain lubricant.

 **Do not use waste oil.** Renewed contact with waste oil can cause skin cancer. Moreover, waste oil is environmentally harmful.

 Waste oil does not have the necessary lubricating properties and is unsuitable for chain lubrication.

Filling Chain Oil Tank



Preparations

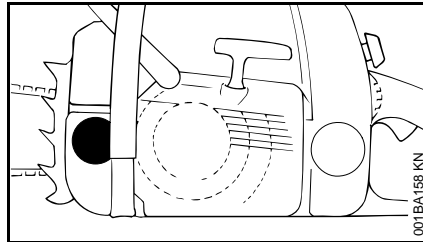

- Thoroughly clean the oil filler cap and the area around it to ensure that no dirt falls into the tank.
- Position the machine so that the filler cap is facing up.
- Open the filler cap.

Fill up with chain oil.

- Refill the chain oil tank every time you refuel.

Take care not to spill chain oil while refilling and do not overfill the tank.

STIHL recommends you use the STIHL filler nozzle for chain oil (special accessory).

- Close the filler cap.

There must still be a small amount of oil in the oil tank when the fuel tank is empty.

If the oil level in the tank does not go down, the reason may be a fault in the oil supply system: Check chain lubrication, clean the oilways, contact your dealer for assistance if necessary. STIHL recommends that you have servicing and repair work carried out exclusively by an authorized STIHL servicing dealer.

Checking Chain Lubrication

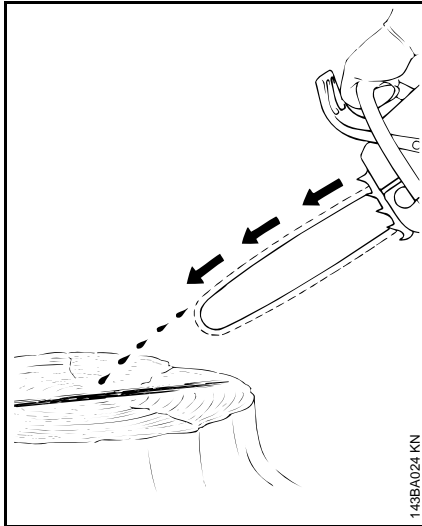

The saw chain must always throw off a small amount of oil.



Never operate your saw without chain lubrication. If the chain runs dry, the whole cutting attachment will be irretrievably damaged within a very short time. Always check chain lubrication and the oil level in the tank before starting work.

Every new chain has to be broken in for about 2 to 3 minutes.

After breaking in the chain, check chain tension and adjust if necessary – see "Checking Chain Tension".

Chain Brake



Locking the chain

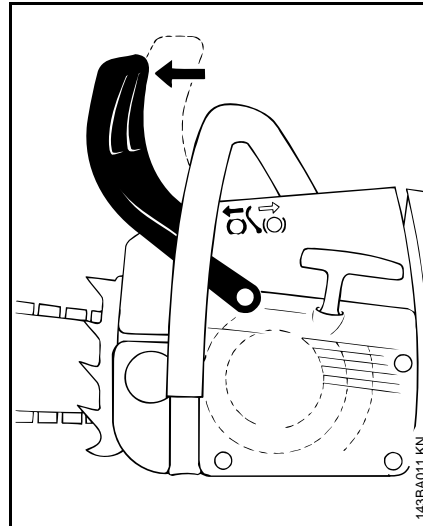

- in an emergency
- when starting
- at idling speed

The chain brake is activated by pushing the hand guard toward the bar nose with your left hand – or by inertia in certain kickback situations: The chain is stopped and locked.

Releasing the chain brake

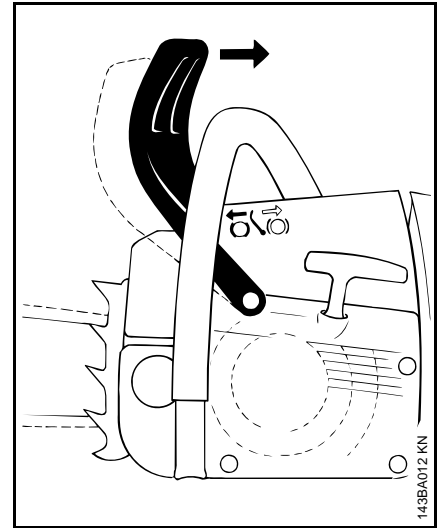

- Pull the hand guard back toward the front handle,



Always disengage chain brake before accelerating the engine (except when checking its operation) and before starting cutting work.

High revs with the chain brake engaged (chain locked) will quickly damage the powerhead and chain drive (clutch, chain brake).

The chain brake is also activated by the inertia of the front hand guard if the kickback force of the saw is high enough: The hand guard is accelerated toward the bar nose – even if your left hand is not behind the hand guard, e.g. during felling cut.

The chain brake will operate only if the hand guard has not been modified in any way.

Check operation of the chain brake

Before starting work: Run engine at idle speed, engage the chain brake (push hand guard toward bar nose) and open the throttle wide for no more than 3 seconds – the chain must not rotate. The hand guard must be free from dirt and move freely.

Chain brake maintenance

The chain brake is subject to normal wear. It is necessary to have it serviced and maintained regularly by trained personnel. STIHL recommends that you have servicing and repair work carried out exclusively by an authorized STIHL servicing dealer. Maintain the following servicing intervals:

Full-time usage:	every 3 months
Part-time usage:	every 6 months
Occasional usage:	every 12 months

Information Before You Start

The four positions of the Master Control lever

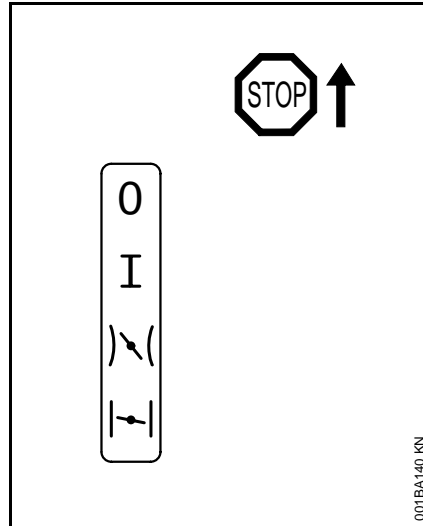

Stop 0 – engine off – ignition is switched off

Operating position I – engine is running or can start

Warm start)\| – this position is for starting the warm engine

Cold start | \| – this position is for starting the cold engine

Adjust Master Control lever

The throttle trigger interlock and throttle trigger must be pressed simultaneously to adjust the Master Control lever from the operating position **I** to cold start | \|.

To set the Master Control lever to warm start)\|, first set it to cold start | \|, then push the Master Control lever into the warm start)\| position.

Changing to warm start)\| is only possible from the cold start | \| position.

When the throttle trigger is squeezed, the Master Control lever returns from warm start)\| to the operating position **I**.

To switch off the engine, set the Master Control lever to Stop **0**.

Starting / Stopping the Engine

Only versions with Easy Start system

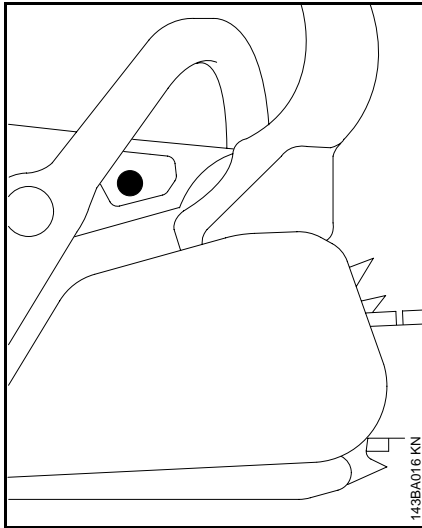

- Press the button, the decompression valve will be opened

It is closed automatically when the engine starts for the first time.

- For this reason, press the button again before each additional starting procedure

For all versions

- Observe safety precautions

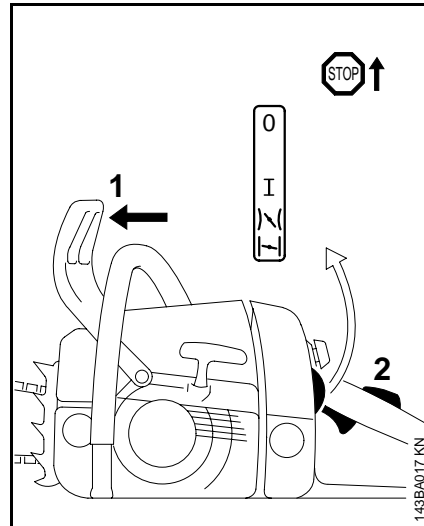

- Push the hand guard (1) forwards: the saw chain is blocked
- Simultaneously press and hold down the throttle trigger interlock (2) and throttle trigger – set master control lever

⚡ if engine is cold

⚡ if engine is warm – once the engine has been running for approx. one minute

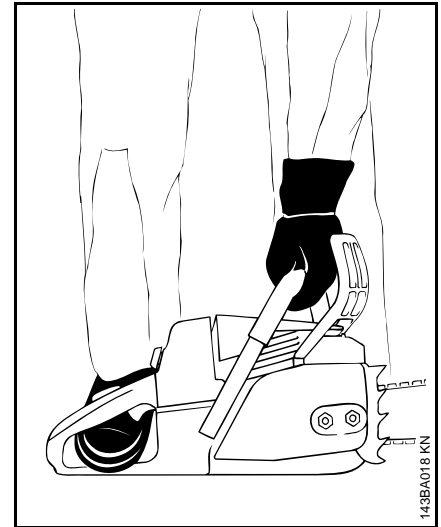

- Place the chain saw securely on the ground and assume a steady stance – the saw chain must not touch any objects and also must not touch the ground

⚠ There must not be anyone within the swivel range of the saw.

- With the left hand on handlebar, press the chain saw firmly against the ground – thumb wrapped around the handlebar
- Place your right foot through the rear handle

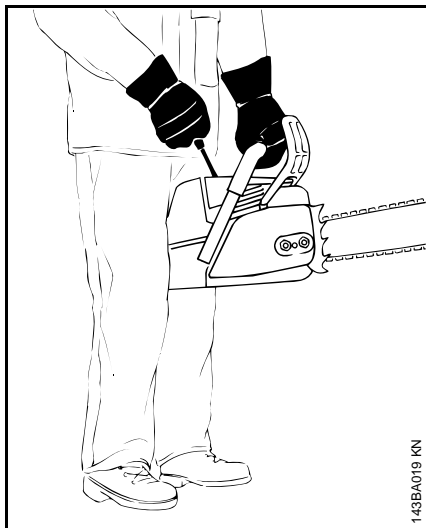

143BA019 KN

another possibility:

- clamp the rear handle between the knees or thighs
- grip the handlebar firmly with the left hand – thumb wrapped around the handlebar

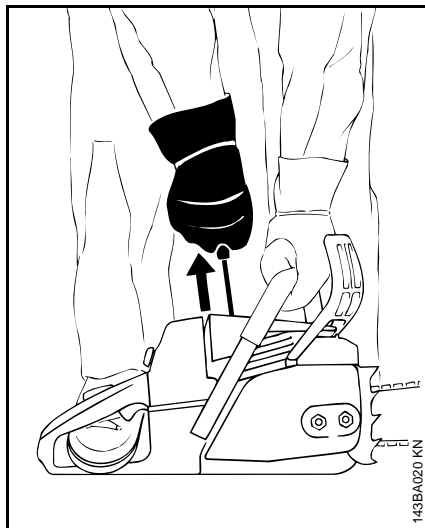

143BA020 KN

With a new engine, pull the starter rope several times to prime the fuel line.

For standard versions

- with the right hand, pull the starter grip slowly until you feel it engage – and then give it a brisk strong pull – simultaneously press down on the handlebar – do not pull the starter rope out all the way – **risk of breakage!**
- Do not let the starter grip snap back – guide it slowly back into the housing so that it can rewind properly

For versions with ErgoStart

The ErgoStart stores the energy for starting the chain saw. For this reason, a few seconds may pass between the pulling of the starter rope and the starting of the engine.

- with the right hand, pull the starter grip slowly and smoothly – simultaneously press down on the handlebar – do not pull the starter rope out all the way – **risk of breakage!**
- Do not let the starter grip snap back – guide it slowly back into the housing so that it can rewind properly

When the engine has turned over for the first time

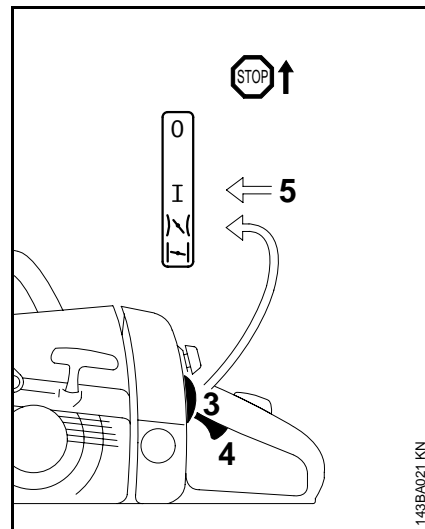



143BA021 KN

- Move the Master Control lever (3) to the  position and continue cranking – once the engine runs, **immediately** blip the throttle trigger (4); the Master Control lever (3) jumps to the operating position I, and the engine begins to idle

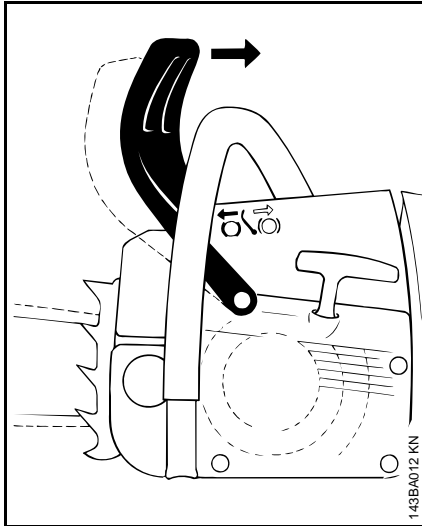

The engine must be switched to idle **immediately** – otherwise, damage to the engine housing and chain brake may occur when the chain brake is locked.



- Pull the hand guard toward the handlebar: . The chain brake is released – the chain saw is ready for use



Open the throttle only when the chain brake is off. Running the engine at high revs with the chain brake engaged (chain locked) will quickly damage the shortblock and chain drive (clutch, chain brake).

- first always check chain lubrication

At very low outside temperatures: Let the engine warm up

As soon as engine is running

MS 170, MS 170 C, MS 180, MS 180 C

- Blip the throttle trigger = disengage starting throttle position – the Master Control lever jumps to the operating position – engine begins to idle
- Release the chain brake: Pull the hand guard toward the handlebar – as shown in the picture
- Open throttle slightly – warm up engine for a short period

Switch off engine

- Move the Master Control lever to the stop position **0**

If the engine does not start

The Master Control lever was not returned to its "warm start" position  in time when the engine turned over the first time and has now flooded.

- Move the Master Control lever to the stop position **0**
- Remove the spark plug – see "Spark plug"
- Dry the spark plug
- Crank the engine several times with the starter – to clear the combustion chamber
- Reinstall the spark plug – see "Spark plug"
- Set the Master Control lever to warm start  – even if the engine is cold
- Restart the engine

When the fuel tank has run completely empty (engine shut down) and then been refueled

Versions without Easy Start system

- Pull the starter rope several times to prime the fuel line

Versions with Easy Start system

- Press the fuel pump bulb in the handle housing several times

Operating Instructions

During the break-in period

A factory new machine should not be run at high revs (full throttle off load) for the first three tank fillings. This avoids unnecessarily high loads during the break-in period. As all moving parts have to bed in during the break-in period, the frictional resistances in the shortblock are greater during this period. The engine develops its maximum power after about 5 to 15 tank fillings.

During work



Do not make the mixture leaner to achieve an apparent increase in power – this could damage the engine – see "Adjusting the Carburetor".



Open the throttle only when the chain brake is off. Running the engine at high revs with the chain brake engaged (chain locked) will quickly damage the shortblock and chain drive (clutch, chain brake).

Check chain tension frequently

A new saw chain must be retensioned more frequently than one that has been in use already for an extended period.

Chain cold

Tension is correct when the chain fits snugly against the underside of the bar but can still be pulled along the bar by hand. Retension if necessary – see "Tensioning the Saw Chain".

Chain at operating temperature

The chain stretches and begins to sag. The drive links must not come out of the bar groove on the underside of the bar – the chain may otherwise jump off the bar. Retension the chain – see "Tensioning the Saw Chain".



The chain contracts as it cools down. If it is not slackened off, it can damage the crankshaft and bearings.

After a long period of full-throttle operation

After a long period of full-throttle operation, allow engine to run for a while at idle speed so that the heat in the engine can be dissipated by flow of cooling air. This protects engine-mounted components (ignition, carburetor) from thermal overload.

After finishing work

- Slacken off the chain if you have retensioned it at operating temperature during work.



Always slacken off the chain again after finishing work. The chain contracts as it cools down. If it is not slackened off, it can damage the crankshaft and bearings.

Short-term storage

Wait for engine to cool down. Keep the machine with a full tank of fuel in a dry place, well away from sources of ignition, until you need it again.

Long-term storage

See "Storing the machine"

Taking Care of the Guide Bar

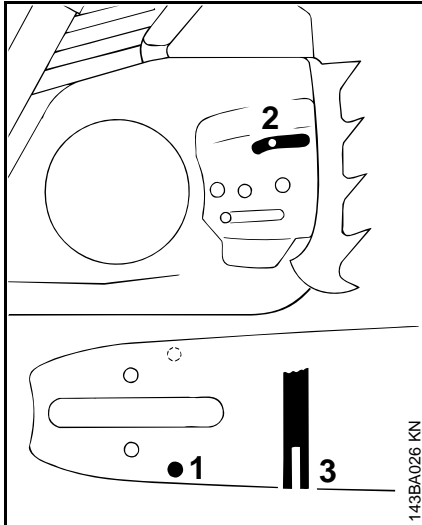

- Turn the bar over – every time you sharpen the chain and every time you replace the chain – this helps avoid one-sided wear, especially at the nose and underside of the bar.
- Regularly clean the oil inlet hole (1), the oilway (2) and the bar groove (3).
- Measure the groove depth – with the scale on the filing gauge (special accessory) – in the area used most for cutting.

Chain type	Pitch	Minimum groove depth
Picco	3/8" P	5.0 mm
Rapid	1/4"	4.0 mm
Rapid	3/8"; 0.325"	6.0 mm
Rapid	0.404"	7.0 mm

If groove depth is less than specified:

- Replace the guide bar.

The drive link tangs will otherwise scrape along the bottom of the groove – the cutters and tie straps will not ride on the bar rails.

Shroud

Remove shroud

The shroud catch may vary depending on the version.

Version A

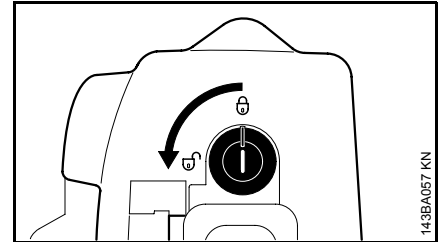

- Use a suitable tool to open the catch by turning it 90° to the left
- Lift off the shroud

Version B

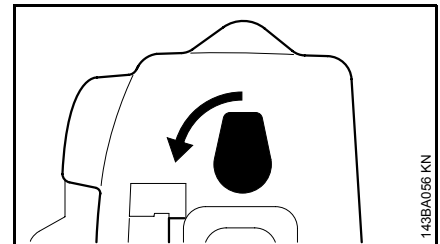

- Turn lever 90° to the left
- Lift off the shroud

Refitting the shroud

Install parts in reverse order.

Cleaning the Air Filter

If there is a noticeable loss of engine power

- Simultaneously press the throttle trigger lockout and throttle trigger and set the Master Control lever to cold start 
- Remove the shroud – see "Shroud"

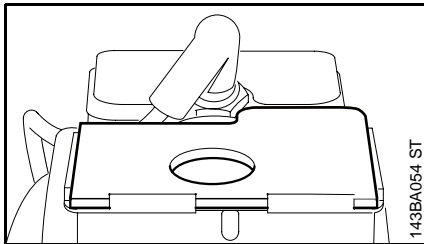

- Pull the filter upwards to remove
- Wash the filter in a clean, non-flammable cleaning liquid (e. g., warm soapy water) and dry it
- Always replace a damaged filter
- Reinstall filter

Adjusting the Carburetor

Basic information

The carburetor has been factory-adjusted to provide the engine with a optimal fuel-air mixture in all operating states.

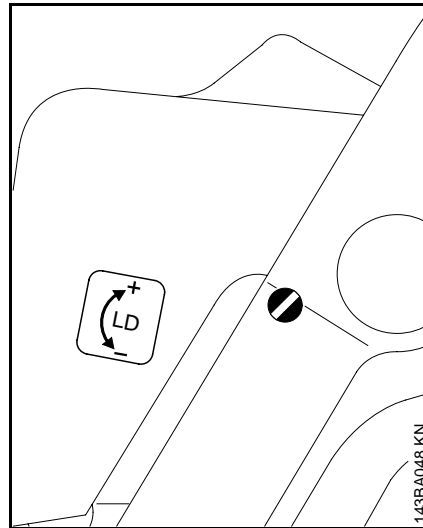

Standard setting

- Check the air filter and replace if necessary
- Check spark arresting screen – clean or replace it if necessary
- Carefully screw the idle speed screw (LD) down counterclockwise (left-hand thread) until it is firmly seated, then 2 turns clockwise (standard setting **LD = 2**)

Setting the idle speed

- Start and warm up the engine
- Using the idle speed screw (LD), set the idle speed correctly: The saw chain must not rotate

Engine speed too low when idling:

- Turn the idle speed adjusting screw (LD) slowly clockwise until the saw chain begins to rotate – then back off 1/2 turn

Saw chain rotates at idle speed:

- Turn the idle speed adjusting screw (LD) slowly counterclockwise until the saw chain stops rotating – then turn an additional 1/2 turn in the same direction

 If the saw chain continues to keep rotating in idle even after adjustment, have the chain saw checked by a servicing dealer.

Spark Arresting Screen in Muffler

In some countries the muffler is equipped with a spark arresting screen.

- If the engine is down on power, check the spark arresting screen in the muffler.
- Wait for the muffler to cool down.

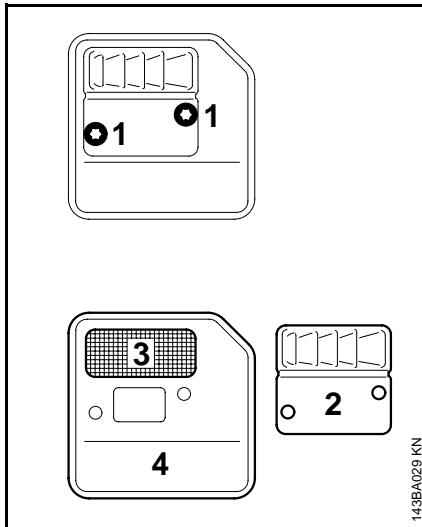

- Take out the screws (1) and remove the cover (2).
- Remove the spark arresting screen (3) from the muffler (4).
- Clean the spark arresting screen. If the screen is damaged or heavily carbonized, fit a new one.
- Refit the spark arresting screen – place the cover in position and secure it with the screws.

Catalytic Converter

Power tools with a catalytic converter (depending on model) must be run on a 50 : 1 mixture of **unleaded gasoline** and **STIHL two-stroke engine oil** or equivalent two-stroke engine oil – see chapter on "Fuel".

The catalytic converter integrated in the muffler reduces the harmful emissions in the exhaust gas.

The correct carburetor setting (if adjustable) and strict observance of the prescribed mix ratio of gasoline and two-stroke engine oil are essential to minimize harmful emissions and ensure a long catalytic converter service life.

Spark Plug

- If the engine is down on power, difficult to start or runs poorly at idle speed, first check the spark plug.
- Fit a new spark plug after about 100 operating hours – or sooner if the electrodes are badly eroded. Install only suppressed spark plugs of the type approved by STIHL – see "Specifications".

Remove the spark plug

- Simultaneously press the throttle trigger lockout and throttle trigger and set the Master Control lever to cold start .
- Remove the shroud – see "Shroud"

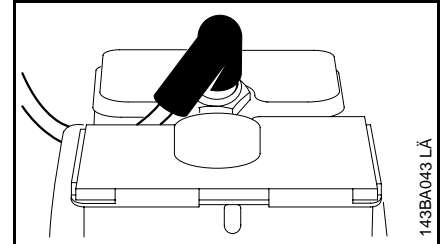

- Pull off the spark plug boot
- Unscrew spark plug

Checking the spark plug

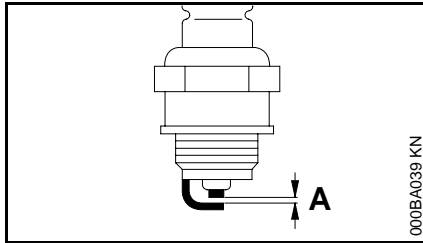

- Clean dirty spark plug.
- Check electrode gap (A) and readjust if necessary – see "Specifications".
- Rectify the problems which have caused fouling of the spark plug.

Possible causes are:

- Too much oil in fuel mix.
- Dirty air filter.
- Unfavorable running conditions.

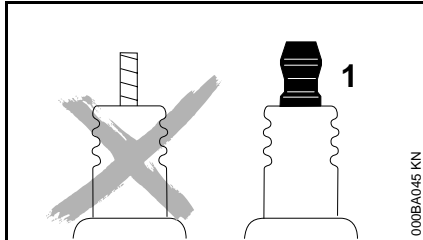

! If the spark plug comes with a detachable adapter nut (1), screw the adapter onto the thread and tighten it down **firmly** to reduce the **risk of arcing and fire**.

Installing the spark plug

- Install the spark plug and connect the spark plug boot (press it down firmly) – reassembly all other parts in the reverse sequence.

Starter rope

 To help prolong service life, observe the following points:

- Pull the starter rope only in the direction specified
- Do not pull the rope over the edge of the guide bush
- Do not pull out the rope more than specified since it might break
- Do not let the starter grip snap back, guide it slowly into the housing

See "Starting / stopping the engine"!

Replace a damaged starter rope in good time or have it replaced by your dealer.

Replacing the starter rope and rewind spring

- Remove the shroud – see "Shroud"
- Unscrew oil filler cap – drain oil tank
- Unscrew fuel tank filler cap – drain fuel tank

Chain oil and fuel mixture must be stored in canisters approved for this purpose.

- Undo the screws on the fan housing and hand guard respectively
- Remove the fan housing
- Tension or, if necessary, replace the starter rope or rewind spring

Storing the Machine

For periods of 3 months or longer

- Drain and clean the fuel tank in a well ventilated area.
- Dispose of fuel properly in accordance with local environmental requirements.
- Run the engine until the carburetor is dry – this helps prevent the carburetor diaphragms sticking together.
- Remove the saw chain and guide bar, clean them and spray with corrosion inhibiting oil.
- Thoroughly clean the machine – pay special attention to the cylinder fins and air filter.
- If you use a biological chain and bar lubricant, e.g. STIHL BioPlus, completely fill the chain oil tank.
- Store the machine in a dry, high or locked location, out of the reach of children and other unauthorized persons.

Checking and Replacing the Chain Sprocket

- Remove chain sprocket cover, saw chain and guide bar.
- Release chain brake – pull hand guard against the front handle

Fit new chain sprocket

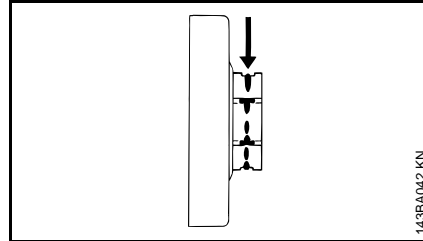

- after use of two saw chains or earlier
- if the wear marks (arrows) are deeper than 0.5 mm – otherwise the service life of the saw chain is reduced – use check gauge (special accessory) to test

Using two saw chains in alternation helps preserve the chain sprocket

STIHL recommends use of original STIHL chain sprockets in order to ensure optimal functioning of the chain brake.

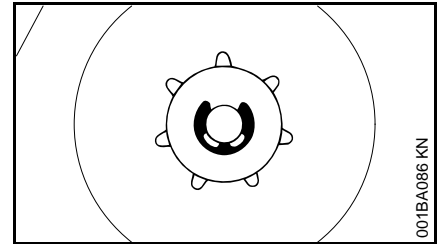

- Use a screwdriver to remove the E-clip
- Remove washer
- Remove the chain sprocket together with the needle cage from the crankshaft

Install chain sprocket

- Clean crankshaft stub and needle cage and lubricate with STIHL lubricant (special accessory)
- Slide needle cage onto the crankshaft stub
- After refitting, turn the chain sprocket approx. 1 full turn so that the carrier for the oil pump drive engages
- Refit washer and E-clip on the crankshaft

Maintaining and Sharpening the Saw Chain

Cutting effortlessly with a correctly sharpened chain

A properly sharpened chain slices through wood effortlessly and requires very little feed pressure.

Do not work with a dull or damaged chain as it will increase the physical effort required, produce unsatisfactory results and a higher rate of wear.

- Clean the chain.
- Check the chain for cracks in the links and damaged rivets.
- Replace any damaged or worn parts of the chain and match the new parts to the shape and size of the original parts.

Carbide-tipped saw chains (Duro) are particularly wear resistant. STIHL recommends you have your chain resharpened by a STIHL servicing dealer.

! It is absolutely essential to comply with the angles and dimensions specified below. If the saw chain is incorrectly sharpened – and in particular if the depth gauge is set too low – there is a risk of increased kickback of the saw, with resulting **risk of injury**.

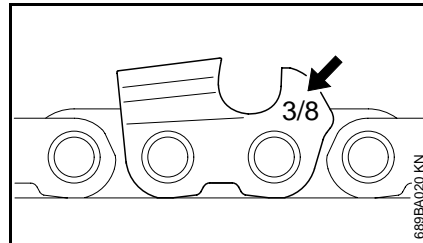

The chain pitch (e.g. 3/8") is marked on the depth gauge end of each cutter.

Use only special saw chain sharpening files. Other files have the wrong shape and cut.

Select file diameter according to chain pitch – see table "Sharpening Tools".

You must observe certain angles when resharpening the chain cutter.

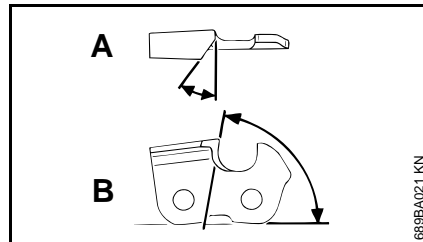

- A** Filing angle
- B** Side plate angle

Chain type	Angle (°)	
	A	B
Rapid Micro (RM)	30	75
Rapid Super (RS)	30	60
Picco Micro (PM)	30	75

Cutter shapes

Micro = Semi-chisel

Super = Full chisel

The specified angles A and B are obtained automatically if the recommended files or sharpening tools and correct settings are used.

The angles must be the same on all cutters. If the angles are uneven: Chain will run roughly, not in a straight line, wear quickly and finally break.

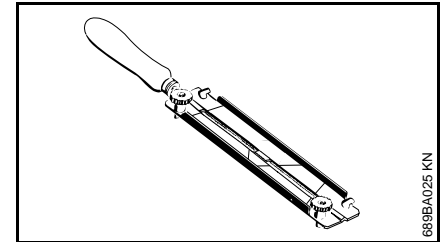

As these requirements can be met only after sufficient and constant practice:

- **Use a file holder**

A file holder must be used for manual resharpening (see table "Sharpening Tools"). The correct filing angles are marked on the file holder.

For checking angles

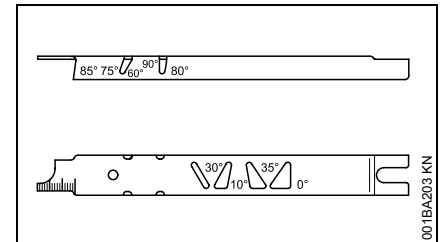

Use a STIHL filing gauge (special accessory, see table "Sharpening Tools"). This is a universal tool for checking the filing and side plate angles,

depth gauge setting, cutter length and groove depth. It also cleans the guide bar groove and oil inlet holes.

File correctly

- Select sharpening tools according to chain pitch.
- Clamp the bar in a vise if necessary.
- Lock the chain – push hand guard forward.
- To rotate the chain – pull hand guard against handle to disengage the chain brake. On models with QuickStop Super, also press down the throttle trigger lockout.
- Sharpen chain frequently, take away as little metal as possible – two or three strokes of the file are usually enough.

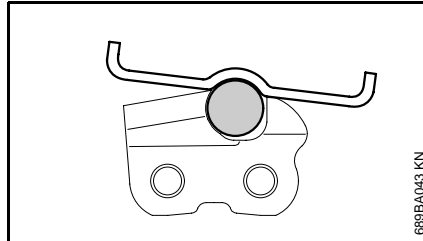
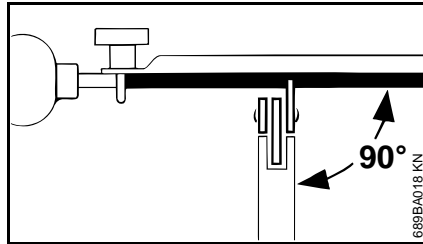

- Hold the file **horizontally** (at a right angle to side of guide bar) and file according to the angles marked on the file holder. Rest the file holder on the top plate and depth gauge.
 - Always file from the inside to the outside of the cutter.
 - The file only sharpens on the forward stroke – lift the file off the cutter on the backstroke.
 - Avoid touching the tie straps and drive links with the file.
 - Rotate the file at regular intervals while filing to avoid one-sided wear.
 - Use a piece of hardwood to remove burrs from cutting edge.
 - Check angles with the filing gauge.
- All cutters must be the same length.

If the cutters are not the same length, they will have different heights. This makes the chain run roughly and can cause it to break.

- Find the shortest cutter and then file all other cutters back to the same length. It is best to have this work done in the workshop on an electric grinder.

Depth gauge setting

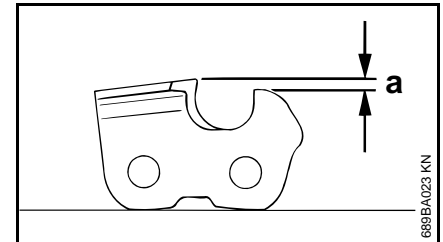

The depth gauge determines the height at which the cutter enters the wood and thus the thickness of the chip removed.

- a** Specified distance or setting between depth gauge and cutting edge.

This setting may be increased by 0.2 mm (0.008") for cutting softwood in mild weather season – no frost.

Chain pitch		Depth gauge setting (a)	
inch	(mm)	mm	(inch)
1/4	(6,35)	0,65	(0,026)
3/8 PM, PMMC3	(9,32)	0,65	(0,026)
0.325	(8,25)	0,65	(0,026)
3/8	(9,32)	0,65	(0,026)
0.404	(10,26)	0,80	(0,031)

Lowering depth gauges

The depth gauge setting is reduced when the chain is sharpened.

- Use a filing gauge to check the setting every time you sharpen the chain.

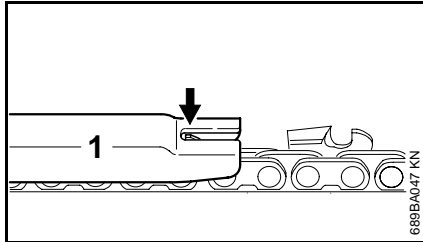

- Place a filing gauge (1) that matches the chain pitch on the chain – if the depth gauge projects from the filing gauge, the depth gauge has to be lowered.

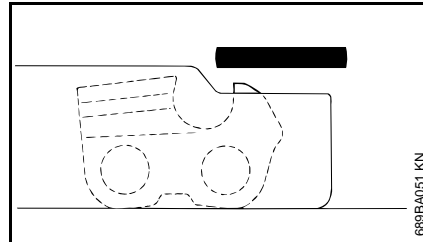

- File down the depth gauge until it is level with the filing gauge.

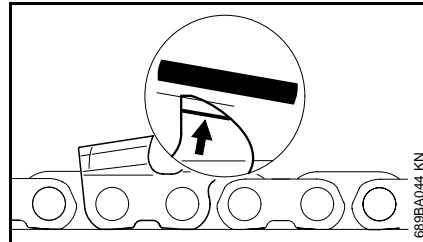

- File the top of the depth gauge parallel to the stamped service marking (see arrow) – but do not lower the highest point of the depth gauge in this process.

⚠ The kickback tendency of the saw is increased if the depth gauges are too low.

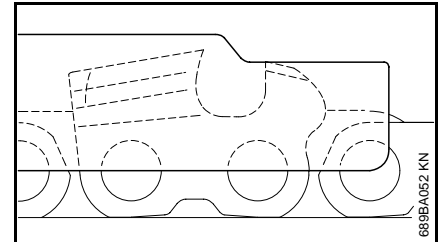

- Place the filing gauge on the chain – the highest point of the depth gauge must be level with the filing gauge.

RSC3, RMC3, PMC3, PMMC3

The upper part of the humped drive link (with service marking) is lowered along with the depth gauge.

⚠ The other parts of the triple-humped tie strap and humped drive link must not be filed since this may increase the kickback tendency of the saw.

- After sharpening, clean the chain thoroughly, remove filings or grinding dust – lubricate the chain thoroughly.
- Before a long out-of-service period, clean the chain and store it in a well-oiled condition.

Sharpening Tools (special accessories)

Chain pitch	Round file Ø	Round file	File holder	Filing gauge	Flat file	Sharpening kit ¹⁾	
inch	(mm)	mm (inch)	Part No.	Part No.	Part No.	Part No.	
$\frac{1}{4}$	(6,35)	4,0 ($\frac{5}{32}$)	5605 772 4006	5605 750 4327	1110 893 4000	0814 252 3356	5605 007 1027
$\frac{3}{8}$ P	(9,32)	4,0 ($\frac{5}{32}$)	5605 772 4006	5605 750 4327	1110 893 4000	0814 252 3356	5605 007 1027
0.325	(8,25)	4,8 ($\frac{3}{16}$)	5605 772 4806	5605 750 4328	1110 893 4000	0814 252 3356	5605 007 1028
$\frac{3}{8}$	(9,32)	5,2 ($\frac{13}{64}$)	5605 772 5206	5605 750 4329	1110 893 4000	0814 252 3356	5605 007 1029
0.404	(10,26)	5,5 ($\frac{7}{32}$)	5605 772 5506	5605 750 4330	1106 893 4000	0814 252 3356	5605 007 1030

¹⁾ consisting of file holder with round file, flat file and filing gauge

Maintenance and Care

The following maintenance intervals apply for normal operating conditions only. If your daily working time is longer or operating conditions are difficult (very dusty work area, resin-rich wood, tropical wood, etc.), shorten the specified intervals accordingly. If you only use the saw occasionally, extend the intervals accordingly.		before starting work	after finishing work or daily	after each refueling stop	weekly	monthly	every 12 months	if problem	if damaged	if required
Complete machine	Visual inspection (condition, leaks)	X		X						
	Clean		X							
Throttle trigger, throttle trigger lockout, choke lever, stop switch, Master Control lever (depending on version)	Check operation	X		X						
Chain brake	Check operation	X		X						
	Have checked by dealer ¹⁾									X
Pickup body/filter in fuel tank	Check					X				
	Clean, replace filter element					X		X		
	Replace						X		X	X
Fuel tank	Clean					X				
Chain oil tank	Clean					X				
Chain Lubrication	Check	X								
Saw chain	Inspect, also check sharpness	X		X						
	Check chain tension	X		X						
	Sharpen									X
Guide bar	Check (wear, damage)	X								
	Clean and turn over									X
	Deburr				X					
	Replace								X	X
Chain sprocket	Check				X					
Air filter	Clean							X		X
	Replace								X	
Anti-vibration elements	Check	X						X		
	Have replaced by dealer ¹⁾								X	

The following maintenance intervals apply for normal operating conditions only. If your daily working time is longer or operating conditions are difficult (very dusty work area, resin-rich wood, tropical wood, etc.), shorten the specified intervals accordingly. If you only use the saw occasionally, extend the intervals accordingly.		before starting work	after finishing work or daily	after each refueling stop	weekly	monthly	every 12 months	if problem	if damaged	if required
Cooling inlets	Clean		X							
Cylinder fins	Clean		X			X				
Carburetor	Check idle adjustment – chain must not rotate	X		X						
	Adjusting Idle Speed									X
Spark plug	Readjust electrode gap							X		
	Replace after 100 hours of operation									
All accessible screws and nuts (not adjusting screws) ²⁾	Retighten									X
Spark arresting screen in muffler (not all markets)	Check ¹⁾							X		
	Clean, replace if necessary ¹⁾								X	
Chain catcher	Check	X								
	Replace								X	
Safety labels	Replace								X	

1) STIHL recommends a STIHL servicing dealer.

2) Firmly tighten down the cylinder base screws of professional saws (3.4 kW or more) after 10 to 20 hours of operation.

Minimize Wear and Avoid Damage

Observing the instructions in this manual helps reduce the risk of unnecessary wear and damage to the power tool.

The power tool must be operated, maintained and stored with the due care and attention described in this owner's manual.

The user is responsible for all damage caused by non-observance of the safety precautions, operating and maintenance instructions in this manual. This includes in particular:

- Alterations or modifications to the product not approved by STIHL.
- Using tools or accessories which are neither approved or suitable for the product or are of a poor quality.
- Using the product for purposes for which it was not designed.
- Using the product for sports or competitive events.
- Consequential damage caused by continuing to use the product with defective components.

Maintenance Work

All the operations described in the "Maintenance Chart" must be performed on a regular basis. If these maintenance operations cannot be performed by the owner, they should be performed by a servicing dealer.

STIHL recommends that you have servicing and repair work carried out exclusively by an authorized STIHL

servicing dealer. STIHL dealers are regularly given the opportunity to attend training courses and are supplied with the necessary technical information.

If these maintenance operations are not carried out as specified, the user assumes responsibility for any damage that may occur. Among other parts, this includes:

- Damage to the engine due to neglect or deficient maintenance (e.g. air and fuel filters), incorrect carburetor adjustment or inadequate cleaning of cooling air inlets (intake ports, cylinder fins).
- Corrosion and other consequential damage resulting from improper storage.
- Damage to the machine resulting from the use of poor quality replacement parts.

Parts Subject to Wear and Tear

Some parts of the power tool are subject to normal wear and tear even during regular operation in accordance with instructions and, depending on the type and duration of use, have to be replaced in good time. Among other parts, this includes:

- Saw chain, guide bar
- Drive components (clutch, clutch drum, chain sprocket)
- Filters (air, oil, fuel)
- Starter mechanism
- Spark plug
- Components of antivibration system

Main Parts

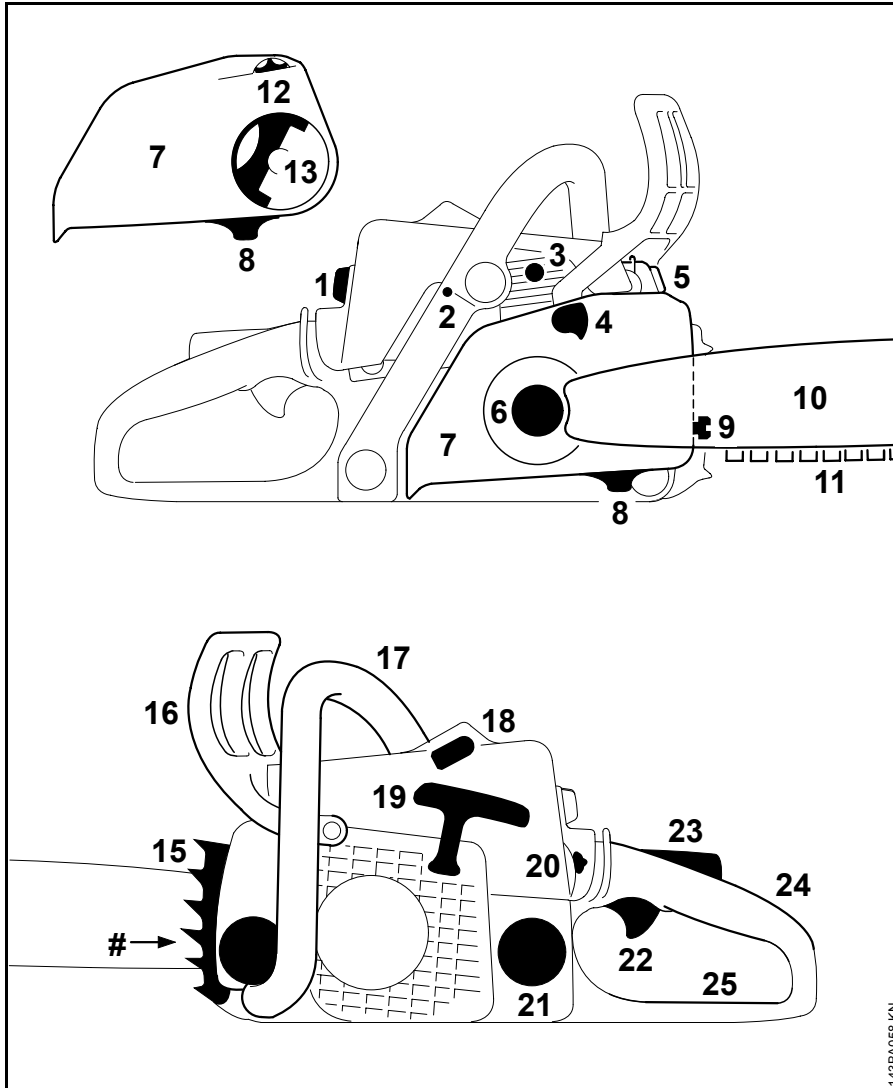

- 1 Shroud catch
- 2 Carburetor adjusting screw
- 3 Decompression valve (depending on equipment version)
- 4 Chain brake
- 5 Muffler
- 6 Chain sprocket
- 7 Chain sprocket cover
- 8 Chain catcher
- 9 Chain tensioner (frontal)
- 10 Guide bar
- 11 Oilomatic saw chain
- 12 Adjusting wheel (quick tensioner)
- 13 Handle
- 14 Oil filler cap
- 15 Bumper spike
- 16 Front hand guard
- 17 Front handle (handlebar)
- 18 Spark plug boot
- 19 Starter grip
- 20 Master Control lever
- 21 Fuel tank twist lock
- 22 Throttle trigger
- 23 Throttle trigger interlock
- 24 Rear handle
- 25 Rear hand guard
- # Serial number

143BA058 KN

Specifications

Engine

STIHL single cylinder two-stroke engine

MS 170, MS 170 C

Displacement:	30.1 cm ³
Bore:	37 mm
Stroke:	28 mm
Engine power to ISO 7293:	1.3 kW (1.8 HP) at 8500 rpm
Idle speed:	2800 rpm

MS 170 with catalytic converter

Displacement:	30.1 cm ³
Bore:	37 mm
Stroke:	28 mm
Engine power to ISO 7293:	1.2 kW (1.6 HP) at 9500 rpm
Idle speed:	2800 rpm

MS 180, MS 180 C

Displacement:	31.8 cm ³
Bore:	38 mm
Stroke:	28 mm
Engine power to ISO 7293:	1.5 kW (2.0 HP) at 9000 rpm
Idle speed:	2800 rpm

Ignition system

Electronic magneto ignition

Spark plug (suppressed):	Bosch WSR 6 F, NGK BPMR 7 A
Electrode gap:	0.5 mm

Fuel system

All position diaphragm carburetor with integral fuel pump

Fuel tank capacity:	0.25 l
---------------------	--------

Chain lubrication

Fully automatic, speed-controlled oil pump with rotary piston

Oil tank capacity:	0.145 l
--------------------	---------

Weight

dry, without bar and chain

MS 170:	3.9 kg
MS 170 with catalytic converter:	4.1 kg
MS 170 C with ErgoStart:	4.2 kg
MS 180:	3.9 kg
MS 180 C with quick tensioner:	4.0 kg
MS 180 C with quick tensioner and ErgoStart:	4.2 kg

Cutting attachment MS 170, MS 170 C

Rollomatic guide bars

Cutting length (3/8" pitch):	30, 35, 40 cm
Groove width:	1.1 mm

Saw chain 3/8"Picco

Picco Micro Mini Comfort 3 (61 PMMC3)

Pitch:	3/8"P (9.32 mm)
Drive link gauge:	1.1 mm

Chain sprocket

6-tooth for 3/8"P (spur chain sprocket)

Cutting attachment MS 180, MS 180 C

Rollomatic guide bars

Cutting length (3/8" pitch):	30, 35, 40 cm
Groove width:	1.1 mm
Groove width:	1.3 mm

Saw chains 3/8"Picco

Picco Micro Mini Comfort 3 (61 PMMC3)

Pitch:	3/8"P (9.32 mm)
Drive link gauge:	1.1 mm

Picco Micro Comfort 3 (63 PMC3),
Picco Duro (63 PD3)

Pitch:	3/8"P (9.32 mm)
Drive link gauge:	1.3 mm

Chain sprocket

6-tooth for 3/8"P (spur chain sprocket)

Sound and vibration levels

The idle, full-throttle and nominal maximum speed are given equal consideration when calculating sound and vibration levels.

For further details concerning compliance with the employers' Directive on vibration 2002/44/EC, see www.stihl.com/vib/

Sound pressure level L_{peq} to ISO 7182

MS 170:	98 dB(A)
MS 170 C:	98 dB(A)
MS 180:	97 dB(A)
MS 180 C:	97 dB(A)

Sound pressure level L_{peq} to ISO 22868

MS 170 with catalytic converter:	100 dB(A)
----------------------------------	-----------

Sound power level L_{weq} to ISO 9207

MS 170:	106 dB(A)
MS 170 C:	106 dB(A)
MS 180:	106 dB(A)
MS 180 C:	106 dB(A)

Sound power level L_{weq} to ISO 22868

MS 170 with catalytic converter:	109 dB(A)
----------------------------------	-----------

Vibration level $a_{hv,eq}$ to ISO 22867

	Handle, left	Handle, right
MS 170:	4.2 m/s ²	5.9 m/s ²
MS 170 with catalytic converter:	4.3 m/s ²	6.2 m/s ²
MS 170 C:	4.2 m/s ²	5.9 m/s ²
MS 180 C:	7.6 m/s ²	7.4 m/s ²

Vibration level $a_{hv,eq}$ to ISO 7505

	Handle, left	Handle, right
MS 180:	6.6 m/s ²	7.8 m/s ²

The K-factor in accordance with Directive 2006/42/EC is 2.5 dB(A) for the sound pressure level and sound power level; the K-factor in accordance with Directive 2006/42/EC is 2.0 m/s² for the vibration measurement.

REACH

REACH is an EC regulation and stands for the Registration, Evaluation, Authorisation and Restriction of Chemical substances.

For information on compliance with the REACH regulation (EC) No. 1907/2006 see www.stihl.com/reach.

Special Accessories

Chain scabbard

If you use guide bars of different lengths on the saw, the length of the chain scabbard must be matched to the guide bar to help reduce the risk of injury.

If the chain scabbard does not cover the full length of the guide bar, a suitable chain scabbard or a scabbard extension is necessary.

Depending on the model, the scabbard extension either comes standard with the saw or is available as a special accessory.

Fitting the chain scabbard extension

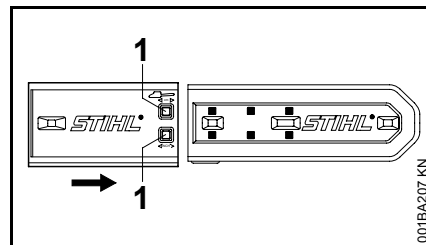

- Push the scabbard extension, locking tabs (1) first, onto the scabbard until the required length is obtained.

Other special accessories

- File holder with round file
- Filing gauge
- Reference gauges

MS 170, MS 170 C, MS 180, MS 180 C

- STIHL lubricating grease
- STIHL filler nozzle for fuel – helps avoid spills and overfilling during refueling
- STIHL filler nozzle for chain oil – helps avoid spills and overfilling

Contact your STIHL dealer for more information on these and other special accessories.

Ordering Spare Parts

Please enter your saw model, serial number as well as the part numbers of the guide bar and saw chain in the spaces provided. This will make re-ordering simpler.

The guide bar and saw chain are subject to normal wear and tear. When purchasing these parts, always quote the saw model, the part numbers and names of the parts.

Model

--	--	--	--	--	--	--	--	--	--	--	--	--	--	--	--

Serial number

--	--	--	--	--	--	--	--	--	--

Guide bar part number

--	--	--	--	--	--	--	--	--	--

Chain part number

--	--	--	--	--	--	--	--	--	--

Maintenance and Repairs

Users of this machine may only carry out the maintenance and service work described in this user manual. All other repairs must be carried out by a servicing dealer.

STIHL recommends that you have servicing and repair work carried out exclusively by an authorized STIHL servicing dealer. STIHL dealers are regularly given the opportunity to attend training courses and are supplied with the necessary technical information.

When repairing the machine, only use replacement parts which have been approved by STIHL for this power tool or are technically identical. Only use high-quality replacement parts in order to avoid the risk of accidents and damage to the machine.

STIHL recommends the use of original STIHL replacement parts.

Original STIHL parts can be identified by the STIHL part number, the **STIHL** logo and the STIHL parts symbol  (the symbol may appear alone on small parts).

EC Declaration of Conformity

ANDREAS STIHL AG & Co. KG
Badstr. 115
D-71336 Waiblingen

hereby confirms that

Model:	Chain saw
Make:	STIHL
Type:	MS 170 MS 170 C MS 180 MS 180 C
Serial identification number:	1130
Displacement	
MS 170:	30.1 cm ³
MS 170 C:	30.1 cm ³
MS 180:	31.8 cm ³
MS 180 C:	31.8 cm ³

conforms to the specifications of Directives 2006/42/EC, 2004/108/EC and 2000/14/EC and has been developed and built in compliance with the following standards:

EN ISO 11681-1, EN 55012,
EN 61000-6-1

The measured and guaranteed equivalent sound power level has been determined in accordance with Directive 2000/14/EC, Annex V, and standard ISO 9207.

Measured sound power level

MS 170:	108 dB(A)
MS 170 with catalytic converter:	111 dB(A)
MS 170 C:	108 dB(A)
MS 180:	109 dB(A)
MS 180 C:	109 dB(A)

Guaranteed sound power level

MS 170:	110 dB(A)
MS 170 with catalytic converter:	113 dB(A)
MS 170 C:	110 dB(A)
MS 180:	111 dB(A)
MS 180 C:	111 dB(A)

The EC type approval test was carried out at the

DPLF

Deutsche Prüf- und Zertifizierungsstelle
für Land- und Forsttechnik (NB 0363)
Max-Eyth-Weg 1
D-64823 Groß-Umstadt

Certification No.:

MS 170:	K-EG-2009/3408
MS 170 C:	K-EG-2009/3408
MS 180:	K-EG-2009/3409
MS 180 C:	K-EG-2009/3409

The technical documentation has been retained by:

ANDREAS STIHL AG & Co. KG
Produktzulassung

The year of construction and the serial number are shown on the machine.

Waiblingen, 08.03.2009

ANDREAS STIHL AG & Co. KG
pp.



Elsner

Head of Product Group Management

Quality Certification



All STIHL products comply with the highest quality standards.

An independent organization has certified that all products manufactured by STIHL meet the strict requirements of the ISO 9001 standard for quality management systems in terms of product development, materials purchasing, production, assembly, documentation and customer service.

0458-207-0121-A

englisch



www.stihl.com



0458-207-0121-A